

ACVATIX™

Electromotoric actuators for valves

SAV..P..



Actuators with 40 mm stroke and 1100 N force

- SAV31P00 Operating voltage AC 230 V, 3-position control signal
- SAV61P00 Operating voltage AC/DC 24 V, positioning signal 0...10V, 4...20 mA
With position feedback, forced control, characteristic changeover
- SAV61P00/MO operating voltage AC/DC 24 V,
RS-485 for Modbus RTU communication
- SAV81P00 Operating voltage AC/DC 24 V, 3-position control signal
- For direct mounting on valves; no adjustments required
- Manual adjuster, position and status indication (LED)
- Optional functions with auxiliary switches, potentiometer

Use

Electromotoric actuators to operate Siemens combi valves for type series VPF43.. and VPF53.. with 40 mm stroke, as control valves on ventilation, air conditioning, district heating and refrigeration plants.

Functions

Function	Description	Type
3-position control	A 3-position signal controls the actuator via connection terminals Y1 or Y2. The desired position is transmitted to the valve.	SAV31P00, SAV81P00
Modulating control	The modulating positioning signal provides stepless motor control. The positioning signal range (DC 0...10 V / DC 4...20 mA / 0...1000 Ω) corresponds to the positioning range (closed...open, or 0...100% stroke) in a linear manner.	SAV61P00
Positioning signal and characteristic changeover	Setting with DIL switch. Factory setting: <ul style="list-style-type: none"> • Characteristic curve: log = Equal percentage (switch set to Off) • Positioning signal: DC 0...10 V (switch set to Off) 	
Position feedback U	Signal returned to acquire the position via input.	SAV61P00, SAV61P00/MO
Forced control (Z-mode)	Forced control helps override automatic mode and is implemented via higher control.	
Calibration	Carry out during initial commissioning. The actuator drives to the top or bottom end position; the measured values are saved.	
Valve seat detection	The actuators have power-dependent seat detection. After calibration, the exact valve stroke is stored in the actuator's memory.	
Foreign body detection	After clogging is detected, three attempts are made to get past clogging. If unsuccessful, the actuator continues to follow the positioning signal only within a limited range, and the LED blinks red.	
Modbus RTU (RS-485), not galvanically isolated	Setpoint 0...100 % valve position Actual value 0...100 % for valve position Override control Open / Close / Min / Max / Stop Setpoint monitoring and backup mode	SAV61P00/MO

Type summary

Type	Item No.	Stroke	Positioning force	Operating voltage	Positioning signal	Spring return time	Positioning time	LED	Manual adjuster	Auxiliary functions
SAV31P00 ¹⁾	S55150-A121	40 mm	1100 N	AC 230 V	3-position	-	120 s	-	Push and fix	3)
SAV61P00 ²⁾	S55150-A119			AC 24 V DC 24 V	DC ... 10 V DC 4...20 mA 0...1000 Ω			Yes		4) 6)
SAV61P00/MO ²⁾	S55150-A144			Modbus RTU				5)		
SAV81P00 ²⁾	S55150-A120			3-position				-		3)

¹⁾ Approbation: CE

²⁾ Approbation: UL

³⁾ Optional accessories: Auxiliary switch, potentiometer

⁴⁾ Position feedback, forced control, characteristic changeover

⁵⁾ Position feedback, forced control

⁶⁾ Optional accessories: Auxiliary switch, sequence control, control action changeover

Scope of delivery

Actuators, valves and accessories are supplied in individual packs.

Accessories/spare parts

Electrical accessories

Type	Auxiliary switch ASC10.51	Potentiometer ASZ7.5/.. ¹⁾	Function module AZX61.1
Item No.	S55845-Z103	S55845-Z104 (ASZ7.5/135) S55845-Z105 (ASZ7.5/200) S55845-Z106 (ASZ7.5/1000)	S55845-Z107
		Max. 2	
SAV31P..	Max. 2	Max. 1	-
SAV61P..		-	Max. 1
SAV61P../MO		-	-
SAV81P..		Max. 1	-

¹⁾ Available in 135Ω, 200 Ω, and 1000 Ω.



Mechanical accessory

Type	Weather shield ASK39.1
Item No.	S55845-Z109

Ordering (example)

Type	Stock number	Designation	Number of pieces
SAV81P00	S55150-A120	Actuator	1
ASZ7.5	S55845-Z106	Potentiometer	1

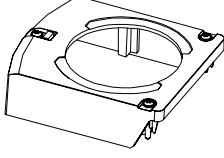
Spare parts

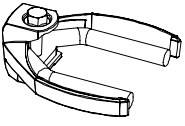
Product number  Stock number	Housing cover	Screw (valve stem coupling)
8000060843		
		U-bracket 

Equipment combinations

VPF43..

Valve type			DN	H ₁₀₀ [mm]	$\dot{V}_{Min.}$ [m ³ /h]	\dot{V}_{m100} [m ³ /h]	Δp_{min} [kPa]	Data sheet
Standard flow	VPF43.100F70	S55266-V106	100	40	14	70	35	N4315
	VPF43.125F110	S55266-V108	125		22	110		
	VPF43.150F160	S55266-V110	150	43	32	160		
	VPF43.200F210	S55266-V148	200		95	210		
High flow rate	VPF43.100F90	S55266-V107	100	40	18	90	70	
	VPF43.125F135	S55266-V109	125		27	135		
	VPF43.150F200	S55266-V111	150	43	40	200		
	VPF43.200F280	S55266-V149	200		130	280		

VPF53..

Valve type			DN	H ₁₀₀ [mm]	$\dot{V}_{Min.}$ [m ³ /h]	\dot{V}_{m100} [m ³ /h]	Δp_{min} [kPa]	Data sheet
Standard flow	VPF53.100F70	S55266-V118	100	40	14	70	35	N4316
	VPF53.125F110	S55266-V120	125		22	110		
	VPF53.150F160	S55266-V122	150	43	32	160		
	VPF53.200F210	S55266-V150	200		95	210		
High flow rate	VPF53.100F90	S55266-V119	100	40	18	90	70	
	VPF53.125F135	S55266-V121	125		27	135		
	VPF53.150F200	S55266-V123	150	43	40	200		
	VPF53.200F280	S55266-V151	200		130	280		

Product documentation

Title	Contents	Document ID
Actuators SAX..., SAY..., SAV..., SAL.. for valves	Basic documentation: Detailed information on stroke actuators including Modbus types Stroke actuators for valves with 15/20/40 mm stroke and rotary actuators for butterfly valves	CE1P4040en
Electromotoric actuators for valves SA..., Modbus RTU	Data sheet: Modbus communication profiles	A6V101037195
Mounting instructions G..161../MO and S..6/MO	Mounting instructions: Mounting and installation instructions for Modbus actuators	A5W00027551
Valve Actuator DIL Switch Characteristic Overview	Commissioning / Configuration: Describes the characteristics of valve and actuator combinations, it describes the DIL Switch function.	A6V12050595

Related documents such as environmental declarations, CE declarations, etc., can be downloaded at the following Internet address:

<http://siemens.com/bt/download>

Notes

Safety

	⚠ CAUTION
	National safety regulations Failure to comply with national safety regulations may result in personal injury and property damage. <ul style="list-style-type: none">● Observe national provisions and comply with the appropriate safety regulations.

	⚠ WARNING
	Risk of burns from hot actuator brackets The actuator brackets on heating plants can also become hot from the contact with the hot valve during operation. The temperature of the actuator bracket can reach 100 °C. When servicing the actuator: <ul style="list-style-type: none">● Switch off both pump and operating voltage.● Close the main shutoff valve in the piping.● Allow the piping to cool off.

Engineering

SAV31P00 / SAV81P00

3-position actuators must be controlled by a controller, see Connection diagrams [→ 14].

SAV61P00

Up to 10 actuators can drive in parallel on a controller output with a rating of 1 mA. Modulating actuators have an input impedance of 100 kΩ.

SAV61P00/MO

The Modbus converter is designed for analog control at 0...10 V.



Keep the analog signal setting on the actuator as is (switch 1 to OFF); adjustment not permitted.

ASZ7.5

Actuators with a DC 0...9.8 V feedback signal are recommended for the combination SIMATIC S5/S7 and position feedback.

Signal peaks in potentiometer ASZ7.5 may result in error messages on Siemens SIMATIC. This is not the cause, however, when combined with Siemens HVAC controllers. The reason is the higher resolution and faster reaction time on SIMATIC.

Use the potentiometer as voltage divider on the 3-wire connection. Powering the potentiometer over the wiper may shorten the life cycle of the potentiometer. Signal peaks increase in frequency and scope over the lifespan in this operating mode.

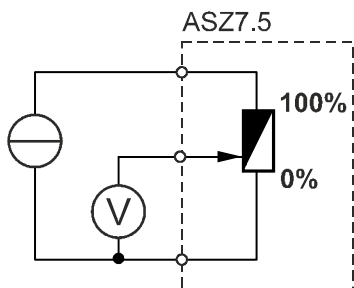

Mounting

Mounting positions

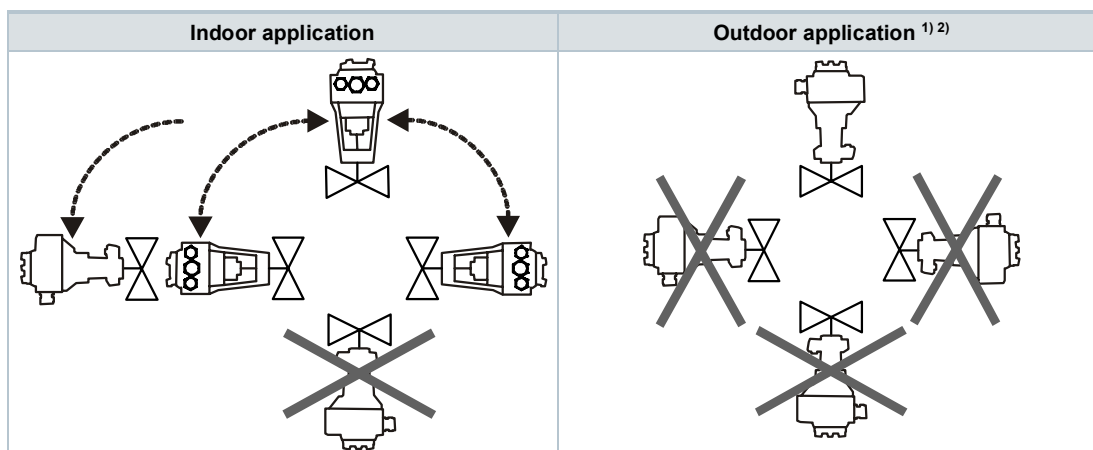

¹⁾ Only together with weather shield ASK39.2. IP54 housing protection remains unchanged.

²⁾ SAV61P../MO is not intended for outdoor use.

Operation

Direction of control action

On valves where the stem retracts to the close position, "direct acting" means that the actuator's stem is extended when positioning signal $Y = 0\text{ V}$ or $Z = 0\ \Omega$.

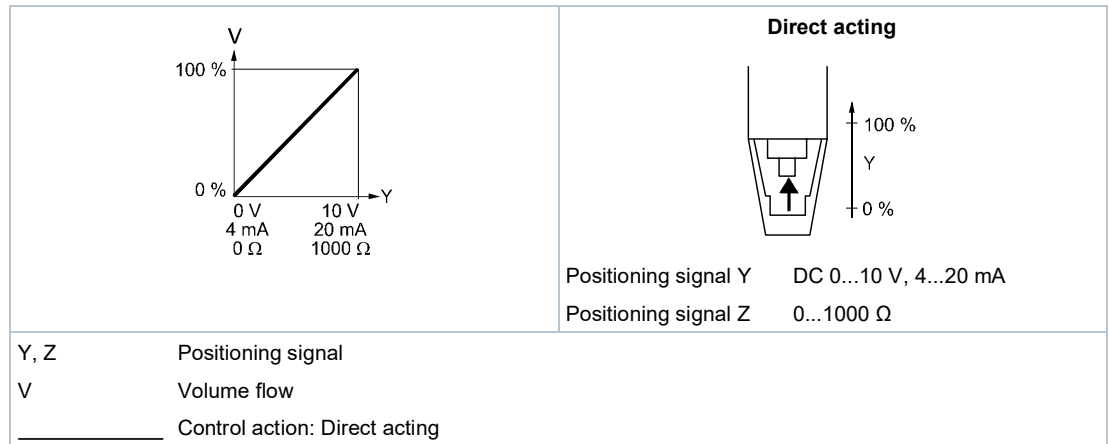

Maintenance

The actuators are maintenance-free.

Disposal



The device is considered an electronic device for disposal in accordance with the European Guidelines and may not be disposed of as domestic garbage.

- Dispose of the device through channels provided for this purpose.
- Comply with all local and currently applicable laws and regulations.

Warranty service

Technical data on specific applications are valid only together with Siemens products listed under "Equipment combinations". Siemens rejects any and all warranties in the event that third-party products are used.

Technical data

Power		
Operating voltage		
SAV31P00		AC 230 V ±15%
SAV61P00..		AC 24 V ± 20 % / DC 24 V +20 % / -15 % (SELV / PELV)
SAV81P00		
Frequency		45...65 Hz
External supply line fusing (EU)		<ul style="list-style-type: none"> • Non-renewable fuse 6...10 A slow • Circuit break max. 13 A, tripping characteristic B, C, D to EN 60898 • Power source with current limitation of max. 10 A
Power consumption at 50 Hz		
SAV31P00		6.5 VA / 4 W
SAV61P00	Stem retracts/extends	9.5 VA / 4.5 W
SAV61P/MO		10.2 VA / 5 W
SAV81P00		7 VA / 4.5 W
Typical inrush current ¹⁾ (3-position actuators)		
SAV31P00		2.3 A
SAV81P00		4.5 A

Operating data		
Positioning times (with the specified nominal stroke)		The positioning time may vary depending on the type of valve (Type summary [→ 3])
SAV31..., SAV61..., SAV81..		120 s
Positioning force		1100 N
Nominal stroke		
On VPF.. DN 100...125		40 mm
On VPF..150		43 mm
Permissible media temperature (valve fitted)		1...120 °C

Signal inputs		
Positioning signal "Y"		
SAV31P00, SAV81P00		3-position
SAV31P00	Voltage	AC 230 V ±15%
SAV81P00		AC 24 V ± 20% / DC 24 V + 20% / - 15%
SAV61P00		
DC 0...10 V	Power consumption	≤ 0.1 mA
	Input impedance	≥100 kΩ
DC 4...20 mA	Power consumption	DC 4...20 mA ± 1%
	Input impedance	≤ 500 kΩ

Communication SAV61P../MO		
Communication protocol		
Modbus RTU		RS-485, not galvanically isolated
Number of nodes		Max. 32
Address range		1...248 / 255
	Factory setting	255
Transmission formats		1-8-E-1 / 1-8-O-1 / 1-8-N-1 / 1-8-N-2
	Factory setting	1-8-E-1
Baud rates (kbaud)		Auto / 9.6 / 19.2 / 38.4 / 57.6 / 76.8 / 115.2
	Factory setting	Auto
Bus termination		120 Ω electronically switchable
	Factory setting	Off

Parallel connection	
SAV61P00	≤ 10 (depending on controller output)

Forced control		
Z positioning signal		
SAV61P00		R = 0...1000 Ω, G, G0
	R = 0...1000 Ω	Stroke proportional to R
	Z connected to G	Max. stroke 100 % ²⁾
	Z connected to G0	Max. stroke 0 % ²⁾
	Voltage	Max. AC 24 V ± 20 % Max. DC 24 V +20% / -15%
	Power consumption	≤ 0.1 mA

Position feedback		
Position feedback U		
SAV61P00		DC 0...10 V
	Load impedance	> 10 kΩ resistive
	Load	Max. 1 mA

Connection cables		
Wire cross-sectional areas		0.75 mm ² , AWG 20...16 ³⁾
Cable entries		
SAV..P..		<ul style="list-style-type: none"> • 2 entries ø 20.5 mm (for M20) • 1 entry ø 25.5 mm (for M25)
SAVP61../MO		
	Fixed connection cable	0.9 m
	Number of cores	5 x 0.75 mm ²

Degree of protection and class		
Housing from vertical to horizontal		IP 54 as per EN 60529 ⁴⁾
Protection class		As per EN 60730
SAV31P00	AC 230 V	II
SAV61P00	AC / DC 24 V	III
SAV81P00		

Environmental conditions			
Operation		IEC 60721-3-3	
	Climatic conditions	Class 3K5	
		Mounting location	Indoors (weather-protected) ⁴⁾
		Temperature, general	-5...55 °C
		Humidity (non-condensing)	5...95 % r.h.
Transportation		IEC 60721-3-2	
	Climatic conditions	Class 2K3	
		Temperature	-25...70 °C
		Humidity	< 95% r.h.
Storage		IEC 60721-3-1	
	Climatic conditions	Class 1K3	
		Temperature	-15...55 °C
		Humidity	5...95 % r.h.
Max. media temperature when mounted on valve		120 °C	

Directives and standards		
Product standard		EN 60730-x
Electromagnetic compatibility (field of use)		For residential, commercial, and industrial environments
EU conformity (CE)		CE1T4503xx ⁵⁾
RCM conformity	AC 230 V	8000078495 ⁵⁾
EAC compliance		Eurasian compliance for all SAV..P..
UL, cUL	AC 230 V	-
	AC / DC 24 V	UL 873 http://ul.com/database ; file number E35198

Environmental compatibility
Product environmental declarations 71 7331 0522 ⁵⁾ and A6V101083254 ⁵⁾ include data on environmentally friendly product design and testing (RoHS compliance, material composition, packaging, environmental benefits, disposal).

Dimensions
See Dimensions [→ 16]

Accessories ⁶⁾			
Potentiometer	ASZ7.5/135	0...135 Ω ± 5 %	
		Voltage	DC 10 V
		Current rating	<4 mA
	ASZ7.5/200	0...200 Ω ± 5 %	
		Voltage	DC 10 V
		Current rating	<4 mA
	ASZ7.5/1000	0...1000 Ω ± 5 %	
		Voltage	DC 10 V
		Current rating	<4 mA

Accessories ⁶⁾		
Auxiliary switch ASC10.51	Switching capacity	AC 24...230 V, 6 (2) A, potential free
External fusing of supply line		<ul style="list-style-type: none"> • Non-renewable fuse 6...10 A slow • Circuit break max. 13 A, tripping characteristic B, C, D to EN 60898 • Power source with current limitation of max. 10 A
US installation, UL & cUL		AC 24 V class 2, 5 A general purpose

- 1) Switching time for RMS value of the sine wave at nominal voltage
- 2) Observe acting direction of DIL switches
- 3) AWG = American wire gauge
- 4) For outdoor operation, always use weather shield ASK39.1, housing protection class IP 54 remains as is. SAV61P00/MO is not intended for outdoor use.
- 5) Documents can be downloaded at <http://www.siemens.com/bt/download>
- 6)

UL-approved component



Connection diagrams

Internal Diagrams

SAV31P00

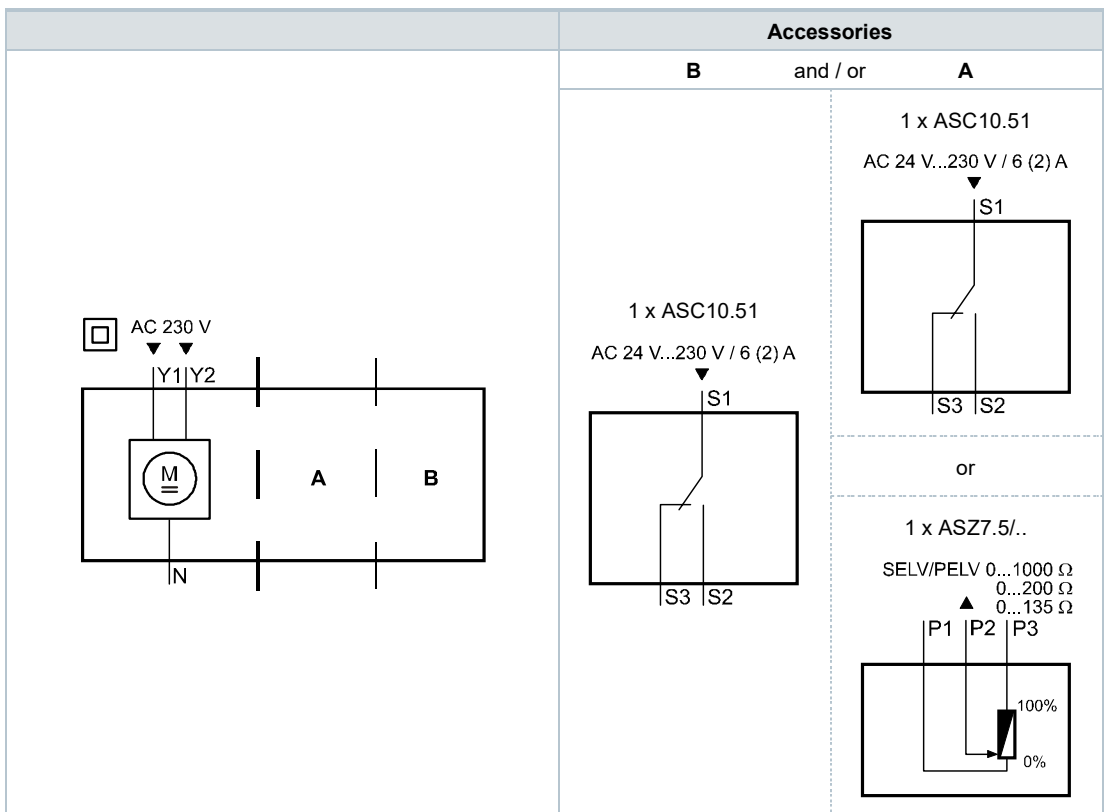

SAV61P..

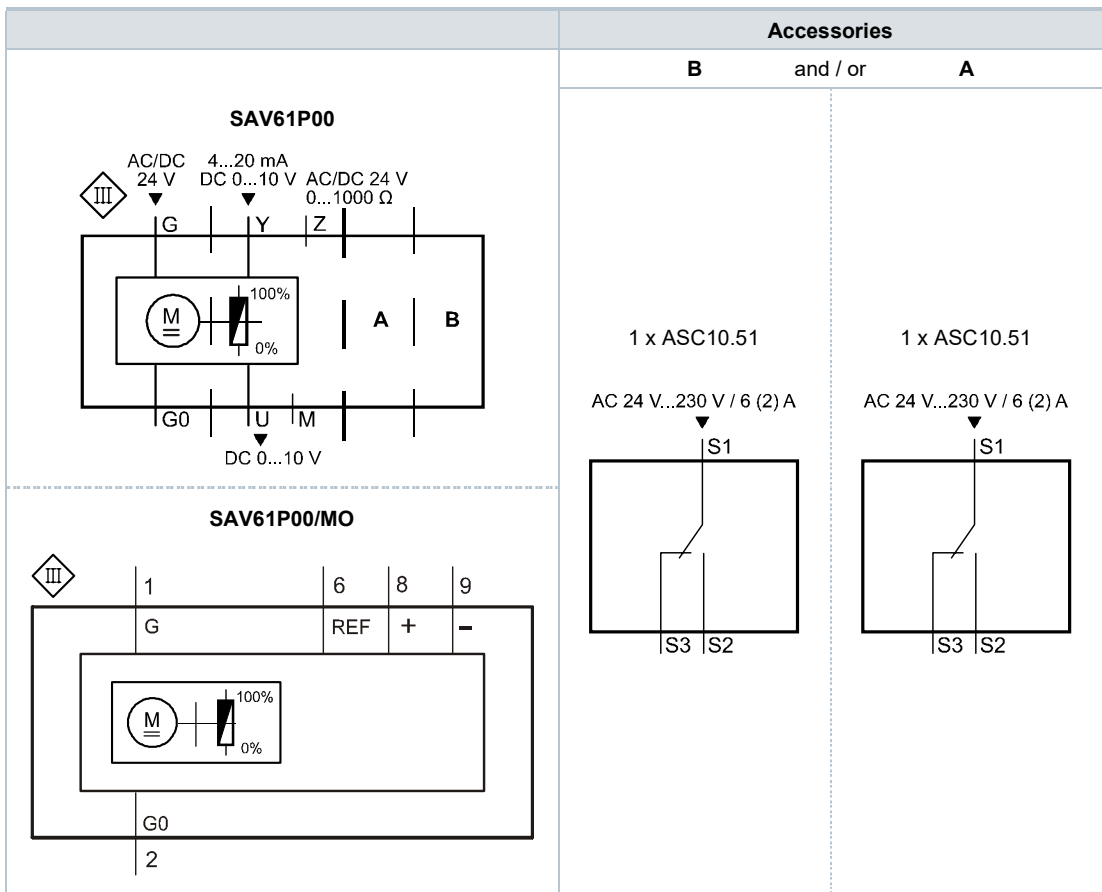

SAV81P00

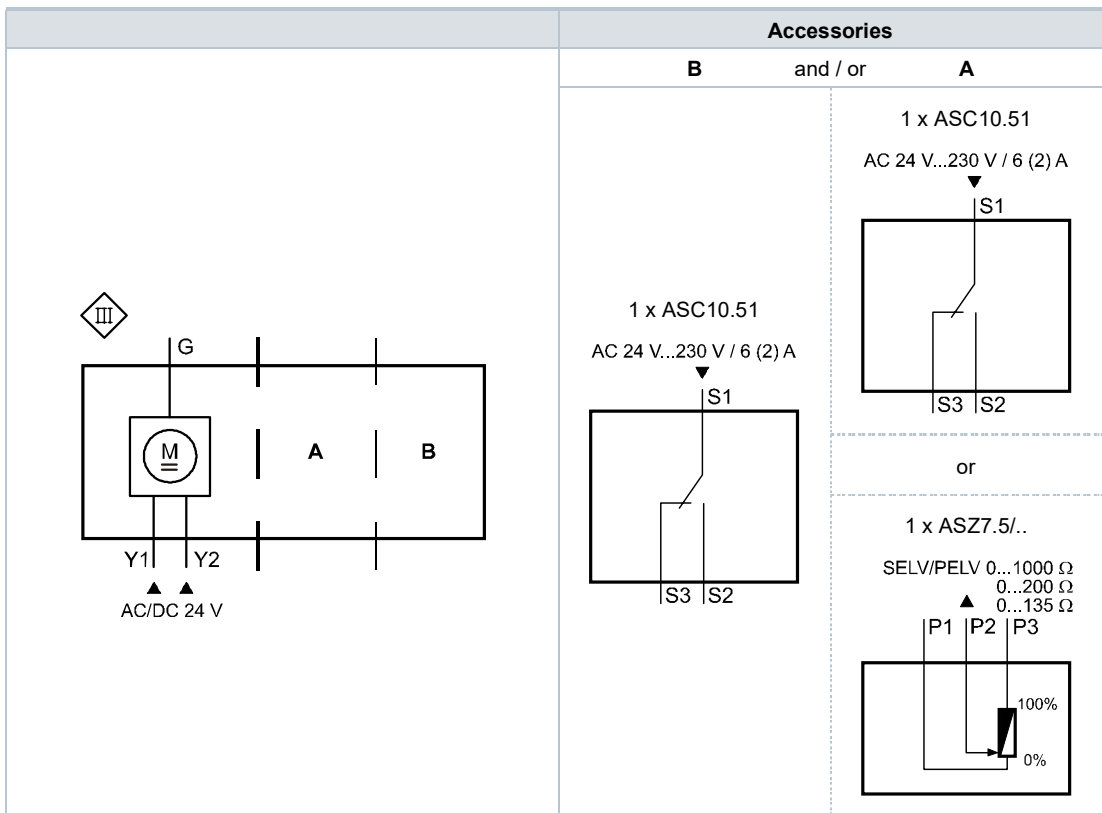

Connection terminals

SAV31P00

	AC 230 V	3-position
N —	System neutral (SN)	
Y1 —	Positioning signal (actuator's stem extends)	
Y2 —	Positioning signal (actuator's stem retracts)	

SAV61P00

	AC / DC 24 V	D 0...10 V 4...20 mA 0...1000
G0 —	System neutral (SN)	
G —	System potential (SP)	
Y —	Positioning signal for DC 0...10 V / 4...20 mA	
M —	Measuring neutral	
U —	Position feedback DC 0...10 V - (System neutral is measuring ground M)	
Z —	Control signal forced control	

SAV61P00/MO

	AC / DC 24 V	Modbus RTU connecting cable
G0 —	System neutral (SN)	black
G —	System potential (SP) AC 24 V / DC 24 V	red
REF —	Reference line (Modbus RTU)	violet
+ —	Bus + (Modbus RTU)	gray
- —	Bus - (Modbus RTU)	pink

SAV81P00

	AC / DC 24 V	3-position
G —	System potential (SP)	
Y1 —	Positioning signal (actuator's stem extends)	
Y2 —	Positioning signal (actuator's stem retracts)	

Connection diagrams

SAV31P00

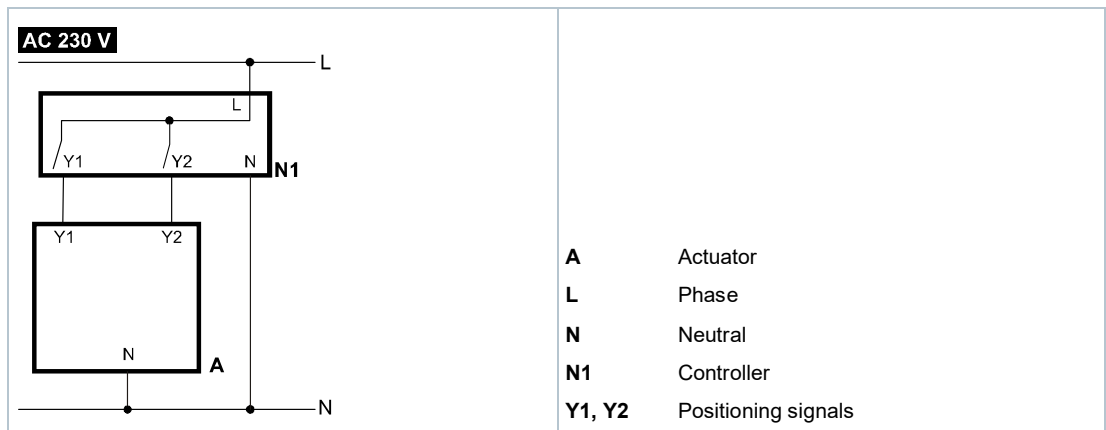

SAV61P00

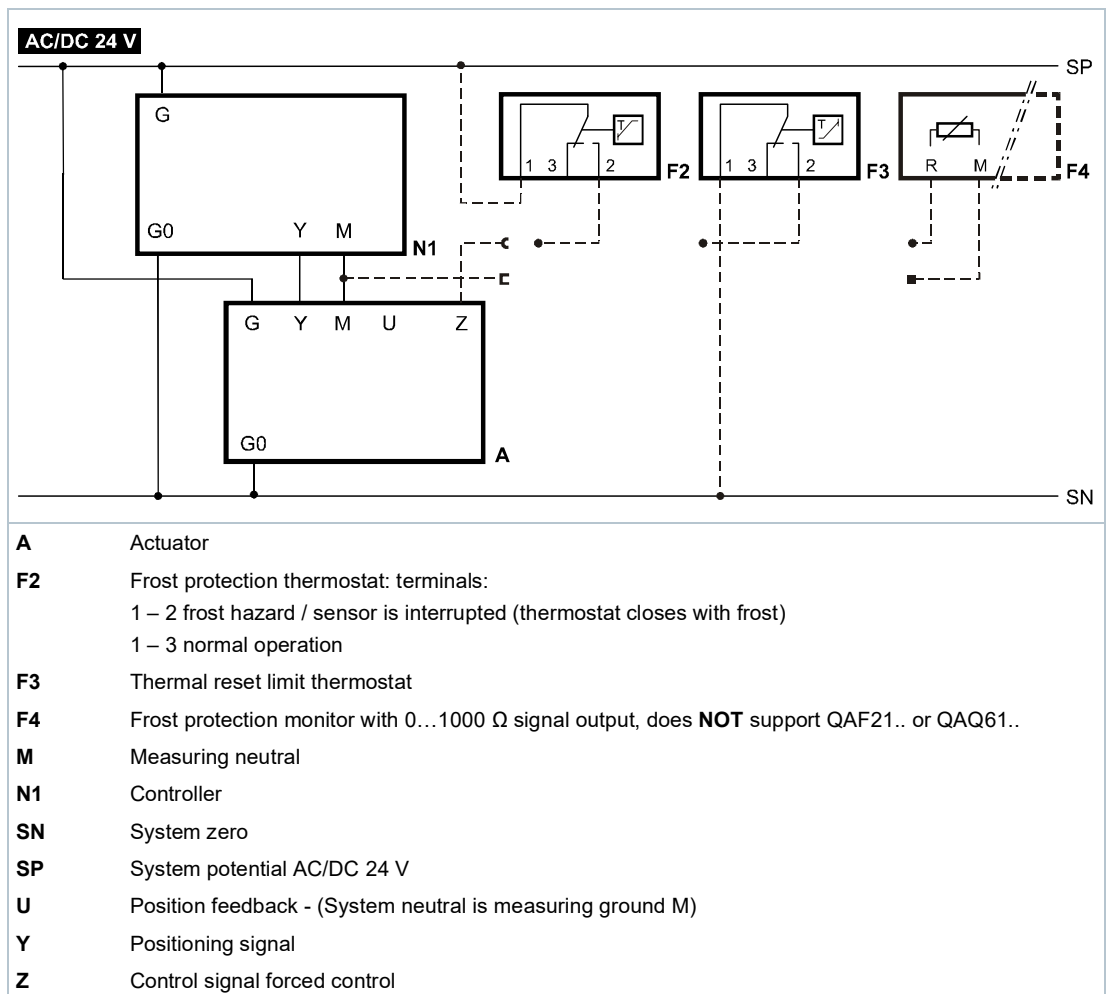

SAV61P00/MO

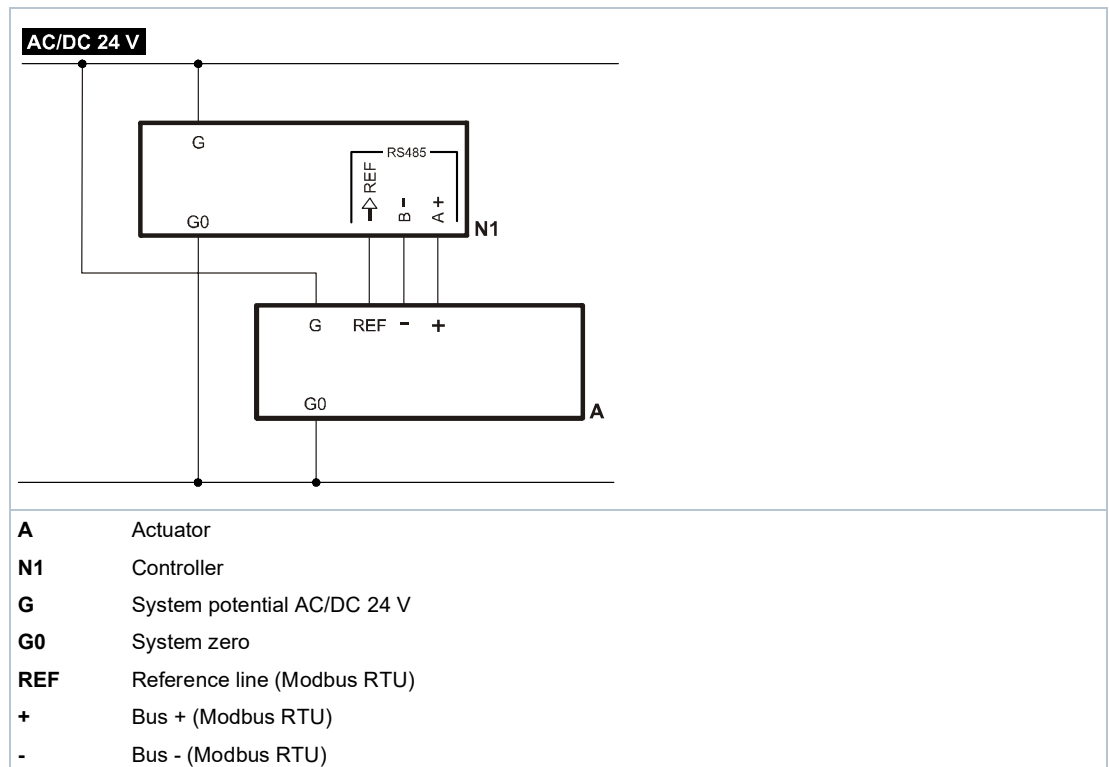

SAV81P00

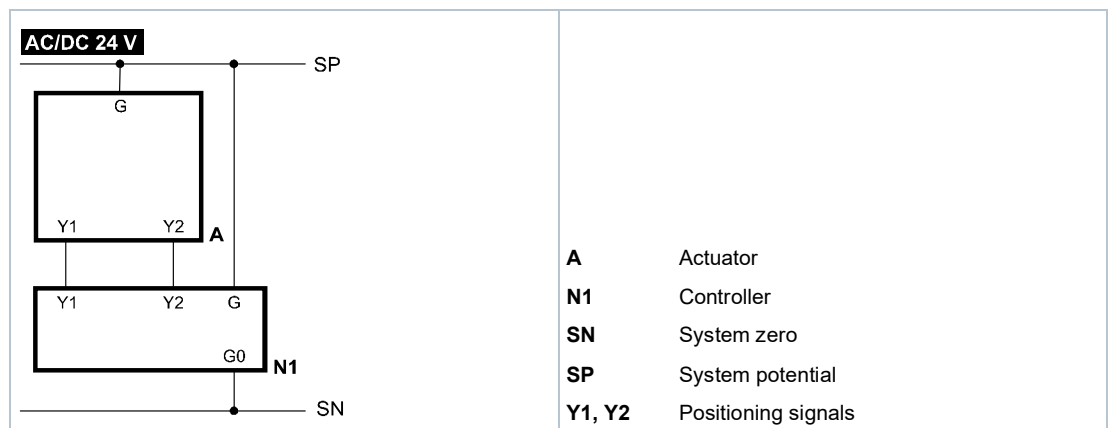

Actuator

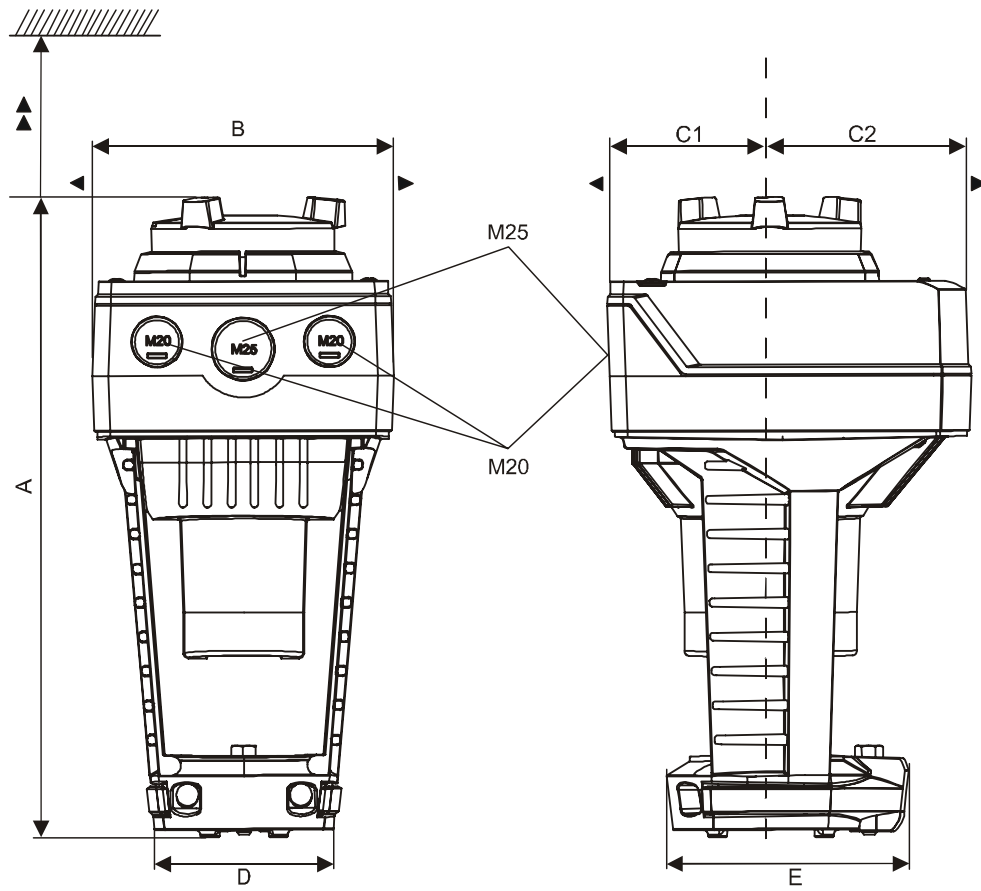

Type	A	B	C	C1	C2	D	E	▶	▶▶	kg
	[mm]									[kg]
SAV..P..	265	124	150	68	82	80	100	100	200	1.920
SAV61P00/MO ¹⁾										2.070
With ASK39.1	290	154	300	200	100			-		2.150

¹⁾ Device has fixed connection cable – left cable entry occupied

External Modbus converter

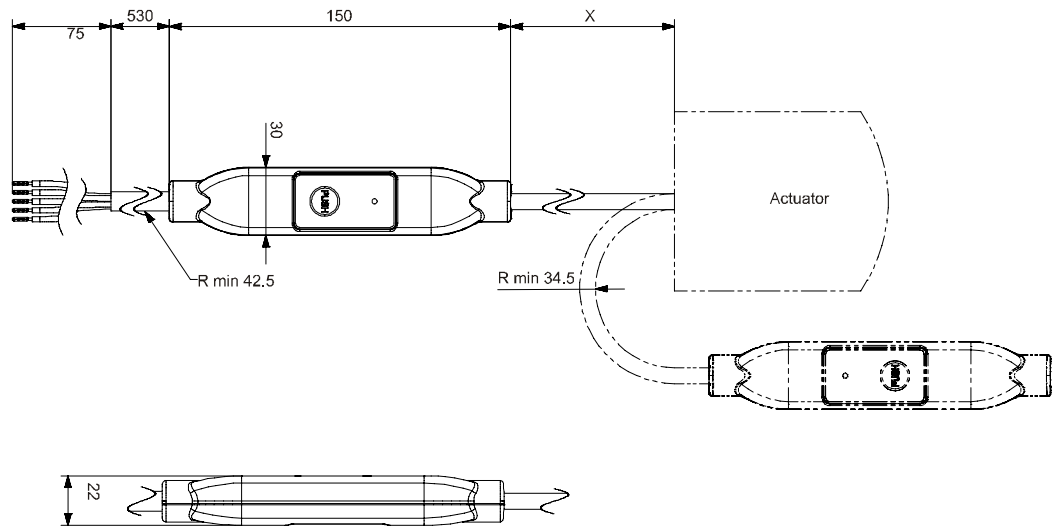

Dimensions in mm

Type	X	
	[mm]	[kg]
SAV61P00/MO	250	0.15 ¹⁾

¹⁾ Included in total weight.

Revision numbers

Type	Valid from rev. no.
SAV31P00	..B
SAV61P00	..C
SAV61P00/MO	..B
SAV81P00	..C