



M-bus web server WTV676-HB6035

M-bus level converter WTV531-GA5060

M-bus level converter WTX631-GA0090

RF converter WTX660-E05060

User's guide

Legal notice

Technical specifications and availability subject to change without notice.

Transmittal, reproduction, dissemination and/or editing of this document as well as utilization of its contents and communication thereof to others without express authorization are prohibited. Offenders will be held liable for payment of damages. All rights created by patent grant or registration of a utility model or design patent are reserved.

Issued by:
Siemens Switzerland Ltd.
Smart Infrastructure
Global Headquarters
Theilerstrasse 1a
CH-6300 Zug
Tel. +41 58 724-2424
www.siemens.com/buildingtechnologies

Edition: 2021-06-21
Document ID: A6V11157985_en--_f

© Siemens Switzerland Ltd, 2017

Contents

Cyber security disclaimer	6
0 About this document	7
0.1 Revision history	7
0.2 Reference documents	7
0.3 Before you start	8
0.3.1 Copyright	8
0.3.2 Quality assurance	8
0.3.3 Document use/request to the reader	8
0.3.4 Acronyms	8
1 Overview	9
1.1 Device functions	9
1.1.1 Level converter WTV531.....	9
1.1.2 Level converter WTX631.....	9
1.1.3 Web server WTV676.....	10
1.1.4 RF converter WTX660-E05060	10
1.2 M-bus properties.....	11
1.2.1 Wired M-bus	11
1.2.2 Wireless M-bus.....	11
1.3 Synco IC.....	12
1.3.1 Functions.....	12
1.3.2 System requirements	12
2 Mounting	13
3 Connections	13
3.1 Level converter WTV531.....	13
3.2 Level converter WTX631.....	14
3.3 Web server	15
3.4 RF converter.....	15
4 Engineering	16
4.1 Topology	16
4.1.1 Wired M-bus devices	16
4.1.2 Wireless devices.....	17
4.2 Operation modes	18
4.2.1 Level converter WTV531.. with ACT531 software.....	18
4.2.2 Level converter with Desigo CC	18
4.2.3 Level converter to extend a M-bus network	19
4.2.4 Web server	20
4.2.5 Web server with level converters.....	20
4.2.6 Web server with RF converters	21
4.2.7 Combined plants.....	22
4.2.8 Synco IC topology.....	23
4.3 Readout of data	23
4.3.1 Readout of data via PC / Internet browser.....	23
4.3.2 Mobile data readout over WLAN	23
4.4 Power supply	24
4.4.1 Level converter WTV531., WTX631.	24
4.4.2 Web server	24
4.4.3 RF converter.....	25

4.5	M-bus	25
4.5.1	M-bus addressing	25
4.5.2	Sizing the wired M-bus system.....	25
5	Installation	27
5.1	Connecting multiple level converters (WTV531., WTX631..).....	27
5.2	Connect web server and level converter.....	27
5.3	Connect web server and RF converter	28
5.4	Connect level converter to a PC.....	28
5.4.1	Level converter WTV531.....	28
5.4.2	Level converter WTX631.....	29
5.5	Connect web server to PC	29
5.6	Connect RF converter to PC	30
5.7	Connect M-bus devices to level converter	30
5.8	Connect M-bus devices to web server.....	30
5.9	Connect wireless M-bus devices to the RF converter	31
5.10	Digital inputs on web server	31
5.11	Digital outputs on web server	32
5.12	Web server access to Synco IC	32
5.12.1	Setup Synco IC reports.....	32
5.12.2	Enable web server in Synco IC	33
5.12.3	Configure email notification in the Synco IC portal.....	33
6	Level converter commissioning.....	34
6.1	Display elements	34
6.1.1	Level converter WTV531.....	34
6.1.2	Level converter WTX631.....	35
6.2	Troubleshooting the level converter.....	36
6.3	Level converter firmware WTV531..	36
7	Commission RF converters.....	37
7.1	Data security and encryption.....	37
7.2	Troubleshooting the RF converter	37
8	Web server commissioning.....	39
8.1	Connect web server to PC or LAN	39
8.2	WTV remote access	40
8.3	M-bus commissioning on web server	41
8.4	Commission RF converters on web server	43
8.5	Web server troubleshooting	43
8.6	Web server integration in Synco IC	44
8.6.1	Setup access.....	44
8.6.2	Activate plant.....	44
9	Level converter operation	45
9.1	Level converter WTV531.....	45
9.2	Level converter WTX631.....	45
10	RF converter operation.....	46
10.1	Change mesh ID.....	47
11	Web server operation on the device	48

11.1	Select default operating language	48
11.2	Buttons	48
11.3	Operating.....	49
12	Web server browser operation	61
12.1	Registration & login.....	61
12.2	Home.....	64
12.2.1	Select the web server language (software interface)	65
12.3	Plant status.....	65
12.3.1	System status.....	65
12.3.2	Wired devices	69
12.3.3	Wireless devices.....	70
12.3.4	Controller.....	72
12.3.5	Inputs/outputs	78
12.4	Settings	79
12.4.1	System	79
12.4.2	Network.....	85
12.4.3	Wired devices	89
12.4.4	Wireless devices.....	100
12.4.5	Inputs/outputs	106
12.5	Export data	107
12.5.1	Manual reports.....	107
12.5.2	Setup automatic reports	109
12.5.3	Creating reports.....	116
12.6	User account	121
12.6.1	User configuration.....	121
12.6.2	Log off	122
13	Appendix.....	123
13.1	Router configuration.....	123
13.1.1	Port forwarding	123
13.2	Open Source Software.....	123
14	Technical data.....	125
15	Revision numbers.....	126
16	Index.....	127

Cyber security disclaimer

Siemens products and solutions include security functions to ensure the secure operation of building automation and control, fire safety, security management, and physical security systems. The security functions on these products and solutions are important components of a comprehensive security concept.

The drafting, implementation, and management of a comprehensive and up-to-date security concepts, adapted to individual needs, is nevertheless unavoidable, and may result in additional plant-specific preventive measures to ensure the secure operation of your overall plant with regard to building automation and control, fire protection, security management, and physical security. These measures may include, but are not limited to, separating networks, physically protecting system components, user training, multi-tiered defensive measures, etc.

For additional information on security as part of building technology and our product offerings, please contact your Siemens sales representative or project department. Strongly recommend to always comply with our security advisories on the latest security threats, patches, and other related measures.

<http://www.siemens.com/cert/de/cert-security-advisories.htm>

0 About this document

0.1 Revision history

Version	Date	Changes	Section	Pages
1.0	30-Jun-2017	First edition		
2.0	31-May-2018	Integration Synco IC	1, 4, 5, 8, 11, 12	9, 16, 27, 39, 48, 61
3.0	12-Oct-2018	Added trend functions	1.3, 4, 5, 8, 12	12, 16, 27, 39, 61
4.0	28-Feb-2019	Added M-Bus lines (M1M2, ABC) Wired devices: Filter search Report interval Reset user account Firmware-Update: Offline only Device list: Edit xls/csv file	3, 4, 5, 11, 12	13, 16, 27, 48, 61
5.0	22.10.2019	Integration of RVD controller, large level converter WTX631.. Firmware Update online or offline Web server connection to the master level converter via terminals A, B, C	12 1, 3, 4, 5, 6, 9	61 9, 13, 16, 27, 34, 45
6.0	21.06.2021	Configuration of scheduler program, backup / restore function WTV remote access WLAN connection Option 'Mobile'	8 12 4.4 11.3 12	39 61 24 49 61

0.2 Reference documents

Ref.	Document title	Type of document	Document no.
[1]	M-bus configuration and readout software ACT531	User's guide	A6V10844345
[2]	M-bus level converter WTV531..	Data Sheet	A6V10844290
[3]	M-bus level converter WTV531..	Mounting instructions	A6V10844308
[4]	M-bus Web Server	Data sheet	A6V11157961
[5]	M-bus Web Server	Mounting instructions	A6V11157964
[6]	RF converter	Mounting instructions	A6V11135905
[7]	Synco IC: Cloud and remote access for OZW772 and OZW672, cloud access for WTV676	User's guide	A6V10500249
[8]	District heating controller for 1 heating circuit and DHW	Installation guide	G2383
[9]	M-bus level converter WTX631..	Data sheet	A6V11742346
[10]	M-bus level converter WTX631..	Mounting instructions	A6V11751461
[11]	Desigo TM TX Open, TX M-Bus	Engineering guide	CM110572

0.3 Before you start

0.3.1 Copyright

This document may be duplicated and distributed only with the express permission of Siemens and may be passed on only to authorized persons or companies with the required technical knowledge.

0.3.2 Quality assurance

These documents were prepared with great care.

- The contents of all documents are checked at regular intervals.
- All necessary corrections are included in subsequent versions.
- Documents are automatically amended as a consequence of modifications and corrections to the products described.

Please make sure that you are aware of the latest document revision date.

If you find any lack of clarity while using this document, or if you have any criticisms or suggestions, please contact your local POC at the nearest branch office.

Addresses for Siemens regional companies are available at www.siemens.com/sbt.

0.3.3 Document use/request to the reader

Before using our products, it is important that you read the documents supplied with or ordered at the same time as the products (equipment, applications, tools etc.) carefully and in full.

We assume that persons using our products and documents are authorized and properly trained and have the requisite technical knowledge to use our products as intended.

Additional information on products and applications is available:

- On the intranet (for Siemens employees only) at <https://workspace.sbt.siemens.com/content/00001123/default.aspx>
- At your next Siemens branch office www.siemens.com/sbt or at your system suppliers.
- By the support team at Headquarters fieldsupport-zug.ch.sbt@siemens.com if local POCs are unknown.

Siemens assumes no liability to the extent allowed under the law for any losses resulting from a failure to comply with the aforementioned points or for the improper compliance of the same.

0.3.4 Acronyms

Dynamic DNS	Dynamic Domain Name System
LAN	Local Area Network
M-bus	Meter Bus
USB	Universal Serial Bus

1 Overview

1.1 Device functions

1.1.1 Level converter WTV531..

The level converter WTV531-GA5060 is a communications interface for reading up to 60 M-bus devices (simple M-bus loads).

The data is read out:

- Locally using the ACT531 PC software via USB
- Locally using the ACT531 PC software via the RS-232 interface
- Via the M-bus web server WTV534.., WTV676..
- Via Desigo CC

Up to six level converters can be connected in parallel to a M-bus web server WTV676.. (Master) on a M-bus network.

Up to 60 M-bus devices can be connected to each level converter WTV531...

The level converters can be used:

- As individual components on a M-bus network.
- To extend a M-bus network by up to six level converters connected in parallel.

You can use the level converter at your own risk as an interface as well to suitable software and devices by third-party manufacturers.

The level converter is protected against short circuits.

1.1.2 Level converter WTX631..

The level converter/repeater WTX631-GA0090 is the interface between M-bus devices and a readout system. It consists of a level converter/repeater and power supply.

Level converter WTX631.. can be connected and used as follows:

- As a slave to line M1M2 on the M-bus web server WTV676.. to read out the device data via the M-bus web server (repeater).
- For reading out device data via the M-bus web server (level converter) over the RS-232 interface
- Via the RS-232 or RS-485 interface to read out the device data via a PXC device or PC (level converter)
- As master on an M-bus network with up to 250 M-bus devices
- As power supply for the M-bus web server.

You can also use the level converter as an interface to suitable third-party software and devices (at your own risk).

The level converter is galvanically isolated and protected against short circuiting.

1.1.3 Web server WTV676..

The web server reads M-bus devices connected directly to the web server as well as M-bus devices connected to the web server via level converters and wireless devices connected to the web server via an RF converter.

It can be used:

- Alone with up to 20 directly connected, wired M-bus devices
- As a master on an M-bus network with up to six connected level converters and a total of 60 logical M-bus devices per line. Up to 250 M-bus devices (max. 250 M-bus meters, max. 250 RVD controllers) can be connected per line.
- As master on a wireless M-bus RF network with up to 23 RF converters, each with up to 500 wireless devices per RF converter.

Web server has a remote readout service (WTV Remote Access) to simplify remote access.

1.1.4 RF converter WTX660-E05060

The RF converter can read out up to 500 devices.

It is used to extend the M-bus radio network. A maximum of 23 RF converters can be used within a single radio network.

1.2 M-bus properties

1.2.1 Wired M-bus

The M-bus system (Meter Bus) is a communications protocol per EN13757-2.

It has the following benefits:

- Highly secure data transmission
- Low wiring costs
- Can be greatly expanded without additional amplifiers
- High number of connectable devices
- Recognizes both battery-powered as well as mains powered devices
- Automated device recognition
- A very large number of systems and devices available
- Various bus topologies can be used (line, bus, star, or tree topology)

1.2.2 Wireless M-bus

The wireless M-bus system communicates using the communications protocol per EN13757-4.

The system also has the following benefits:

- Various network topologies available for radio read out
- The system can be extended over a large area using additional RF converters
- Optimum connection by the RF converter to the web server (mesh network)

1.3 Synco IC

Synco IC integrates the M-bus web server WTV676-HB6035 easily and securely to the cloud. This permits the upload of billing data and alarm messages, Trend data to the cloud per customized settings and sends the information to the corresponding customers via email. The meter information can be saved on the cloud together with additional plant data. Multiple web servers can also be managed on a joint Synco IC account.

1.3.1 Functions

Synco IC has the following functions:

- Simple and secure integration of the M-bus web server
- Centralized overview of meter information
- Transmission of billing data and alarm messages to the customer
- Transmission of trend data to the customer
- Configurable email notifications when transmitting data to the cloud
- Secure communications thanks to encryption (HTTPS).

1.3.2 System requirements

Web server WTV676-HB6035 is required to access the Synco IC cloud (as of firmware version WTV676_WI-2.23_FW-2.4-16-2.3.bin).

Note

The firmware must be updated to firmware version WTV676_WI-2.23_FW-2.4-16-2.3.bin for an older web server WTV676-HB6035 version.

After the web server WTV676-HB6035 is integrated in the Synco IC cloud, billing data, trend data, and alarm messages can be uploaded per settings and sent to the various recipients. Multiple M-bus web servers as well as OZW web servers can be managed on a common Synco IC account.

2 Mounting

The level converter and web server are designed for mounting on 35 mm rails. They take up the equivalent of four standard modules on the rails. Additional information on mounting is available in the mounting instructions for the level converter [3] and the web server [5].

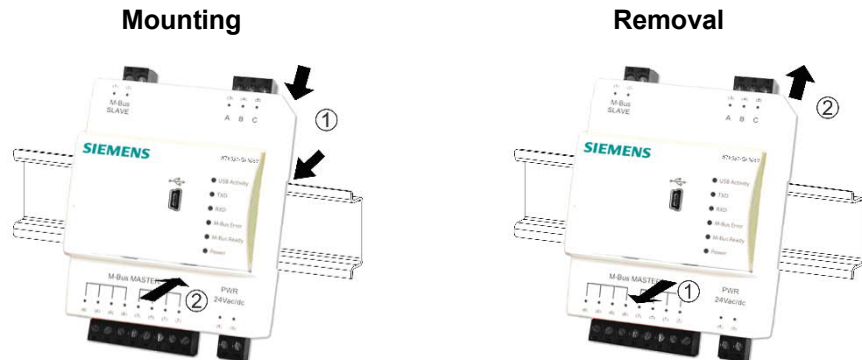

3 Connections

3.1 Level converter WTV531..

The level converter WTV531.. has the following connection terminals / LEDs.

	A	Power supply AC/DC 24V Terminals (8) and (9)
	B	Connections for M-bus devices and. Connections for following slave level converters, if this one is used as the master. Terminals (6) and (7)
	C	Connections to connect to a M-bus web server and / or Connections to connect the prior level converter, if this level converter is used as a slave. Terminals (1) and (2)
	D	RS-232 interface to connect a PC or M-bus master A = TX B = RX C = GND Terminals (3), (4), and (5)
	E	PC connection Mini-USB type B
	F	LEDs

For the meaning of LED indicators, see section Display elements page 34.

3.2 Level converter WTX631..

Level converter WTX631.. has the following connection terminals:

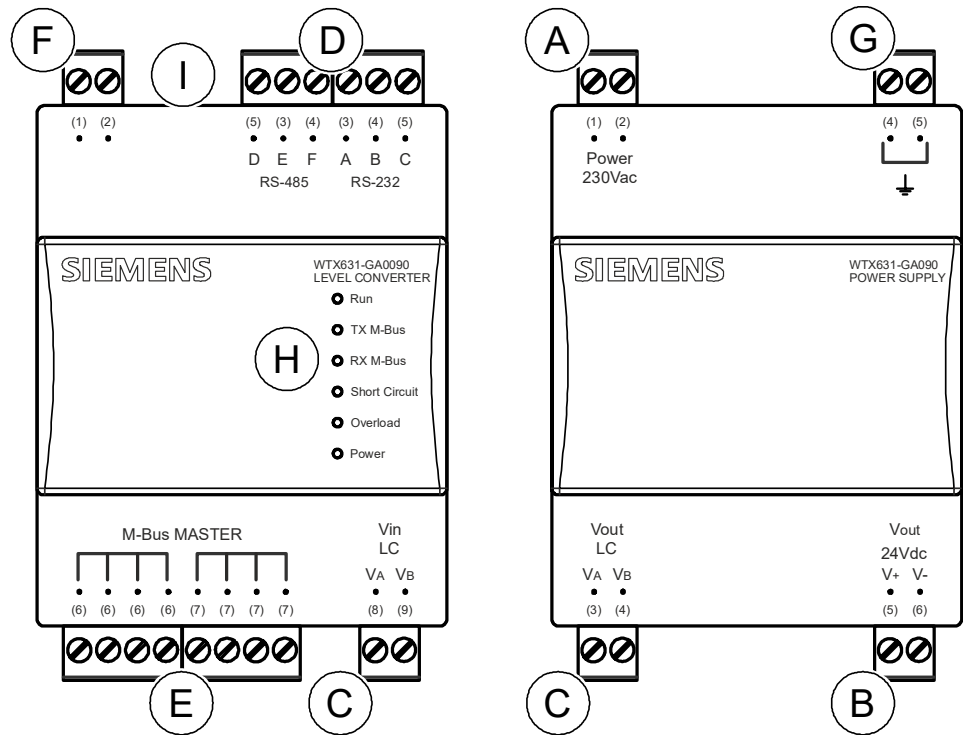

- A Mains power AC 230 V
- B Output for power supply level converter WTX631.. (DC 24 V)
- C Connection to the power supply with the level converter/repeater
- D Serial interface RS-232 and RS-485 to connect to a PC or M-bus master
- E Connections for M-bus devices and repeater
- F Connection to the M-bus web server WTV676.. or to the previous master level converter, if this level converter is used as a repeater.
- G Ground
- H State LEDs
- I Button for firmware update

RS-232	RS-485
A = TX	D = REF
B = RX	E = D-
C = GND	F = D+

- E Connections for M-bus devices and repeater

3.3 Web server

The web server has the following connection terminals / LEDs.

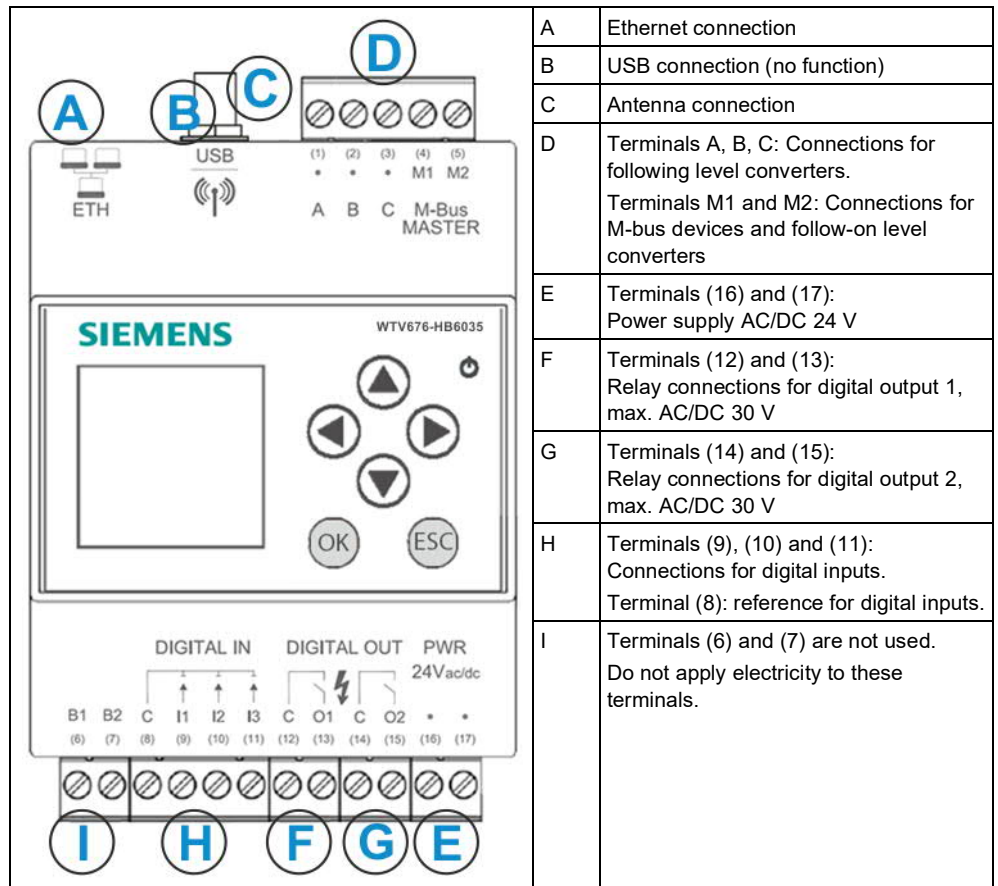

3.4 RF converter

The RF converter is wall mounted.

Additional information on mounting the RF converter is available in document A6V11135905. See "Reference documents", page 7.

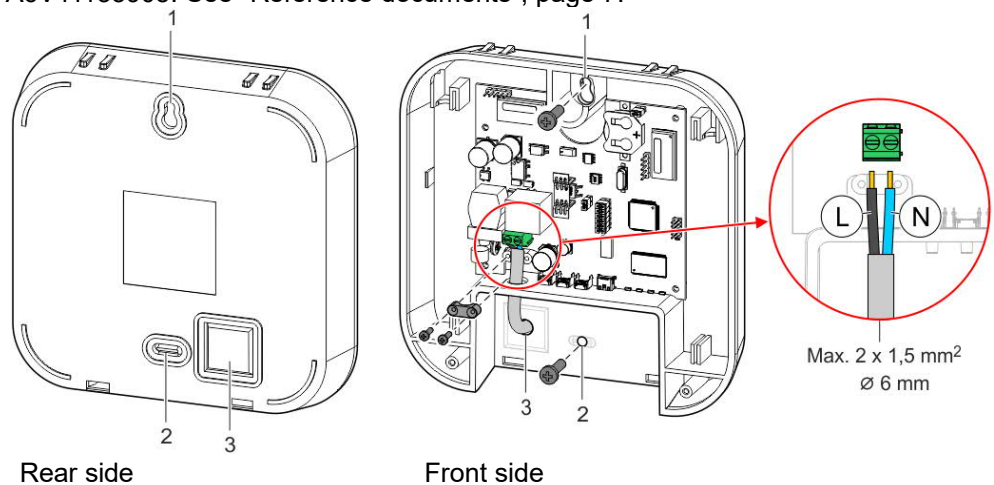

1. Hole for top attaching screw
2. Hole for bottom attaching screw
3. Cable entry

4 Engineering

4.1 Topology

4.1.1 Wired M-bus devices

The M-bus permits various network topologies. The devices can be connected to the level converter or the web server in a line, bus, star, or tree topology, or a combination thereof.

Ring topology is not permitted.

Bus cable polarity is not relevant, simplifying installation.

Line topology



Bus topology



Star topology

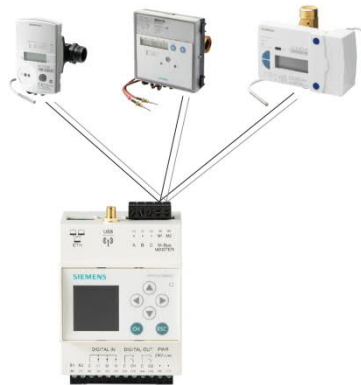

Tree topology



Combination of topologies

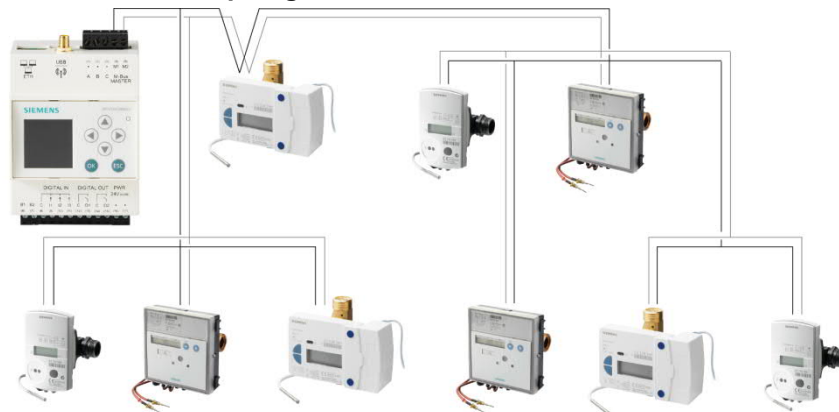

Ring topology



4.1.2 Wireless devices

The web server permits read out using various network topologies. The RF converters are self-organizing and search for the optimum connection to the web server.

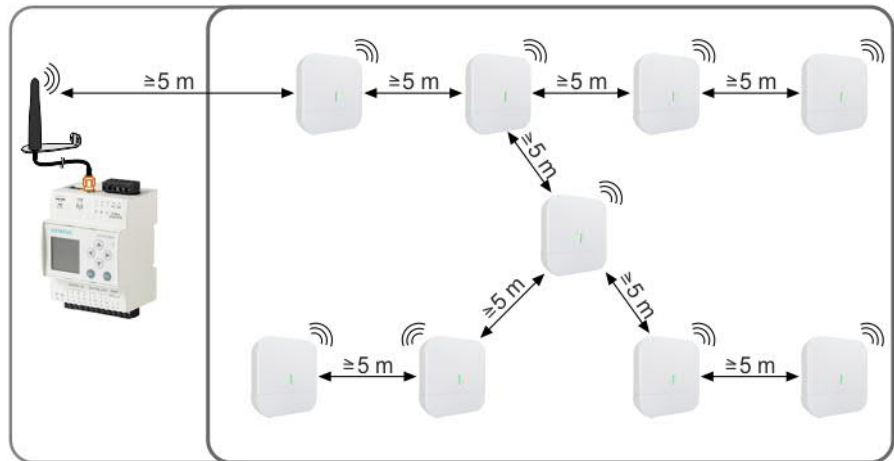

4.2 Operation modes

4.2.1 Level converter WTV531.. with ACT531 software

The level converter is used as the communication interface between M-bus devices and a laptop using the ACT531 software. The ACT531 software can read up to max. of 1,000 devices.

Up to 60 devices (60 unit M-bus loads) can be connected.

The data is read locally using a USB connection or via the RS-232 interface.

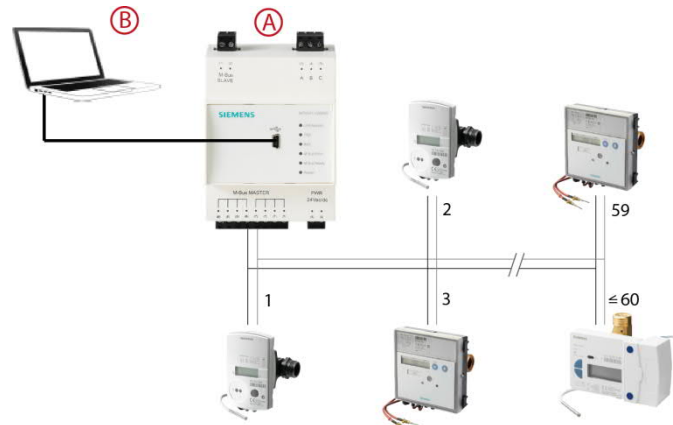

- A Level converter as master
- B Laptop with ACT531 software

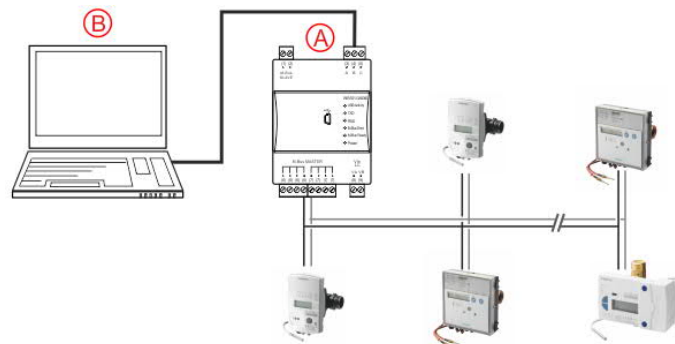

- A Level converter as master
- B Laptop with ACT531 software

4.2.2 Level converter with Desigo CC

The TX Open module integrates M-bus devices in the Desigo CC management platform via the RS-232 interface.

Additional information on the Desigo CC management platform is available in the engineering guide "Desigo TM TX Open, TX M-Bus", document CM110572. See section 'Referenced documents'.

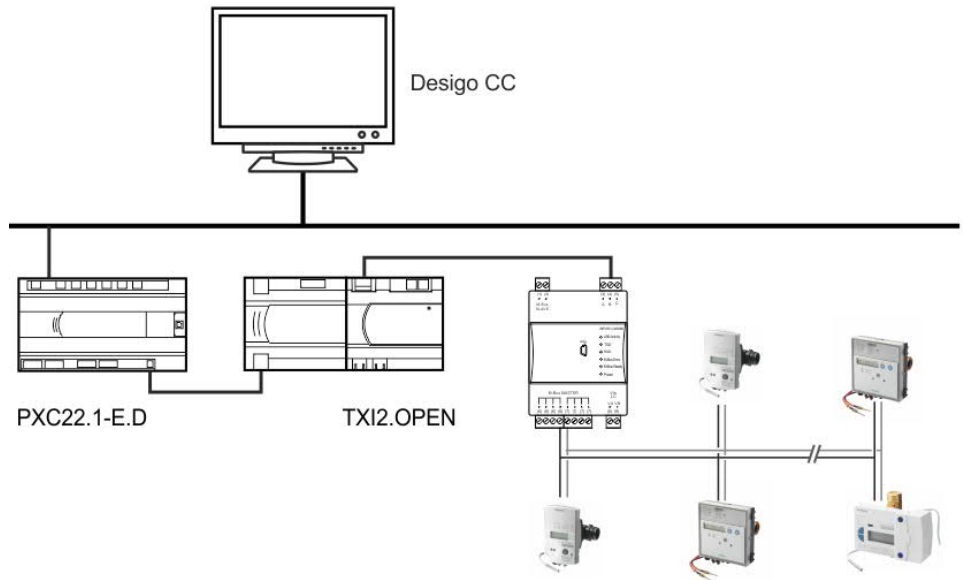

4.2.3 Level converter to extend a M-bus network

The level converter is used to extend the M-bus system by 60 (WTV531..) or 250 (WTV631..) (60 or 250 simple M-bus loads).

The master level converter (A) is connected to a M-bus web server WTV676.. via the RS-232 interface (terminals A, B, C).

The following slave level converters (B) can be connected via the M-bus slave connection.

A maximum of six level converters can be combined to form a network. A maximum of 360 unit M-bus loads or 1,000 logical M-bus devices can be read via the master level converter.

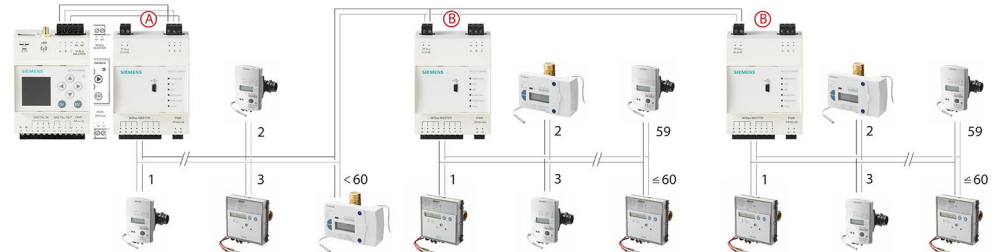

A Level converter as master

B Level converter as slave

Note

The level converter is connected as a slave (B) to the web server (A) (terminals M1M2 of the web server) if the firmware version of the web server WTV676.. is less than SIE.WTV676_WI-2.29_FW-3.0-17-2.6.

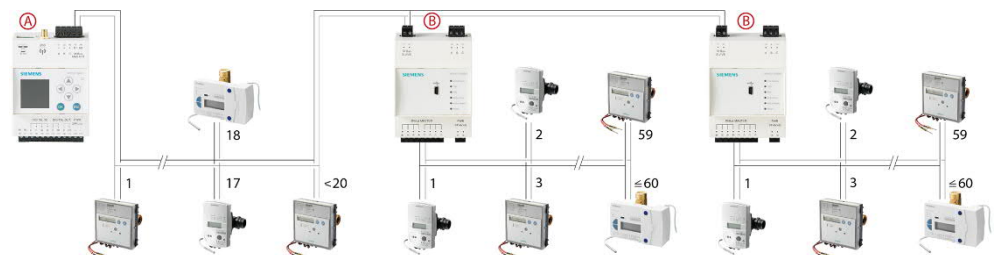

Note

Connect M-bus meters and RVD controllers to different lines, especially if the meters have batteries.

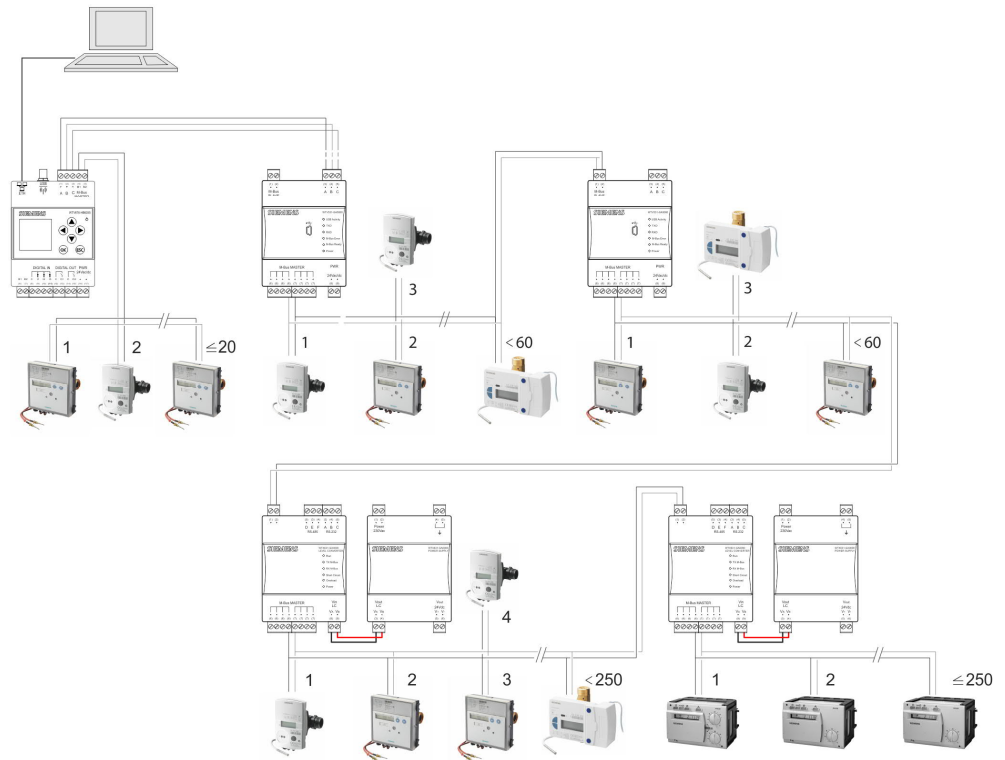

Important

⚠ PC must be connected to the master level converter WTV531.. (A) to readout data and other PCs cannot be simultaneously connected to slave level converters (B).

4.2.4 Web server

The web server is used to read up to 20 directly connected devices (20 unit M-bus loads).

A PC / Internet browser reads the data either locally over Ethernet or from anywhere over the Internet.

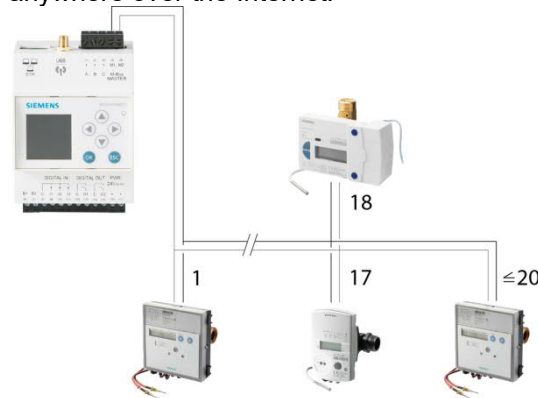

4.2.5 Web server with level converters

The web server is equipped with additional level converters over two lines to extend the system by up to 500 logical M-bus devices (max. 250 per line).

The web server is operated as the master. Up to 20 M-bus devices (20 unit M-bus loads) can be directly connected (Line M1M2).

The level converters are connected as slaves to the web server. Up to 60 M-bus devices can be connected to the level converter WTV531.. and up to 250 M-bus devices can be connected to the level converter WTX631.. (60 or 250 simple M-bus loads).

A maximum of six level converters (WTV531..., WTX631..) can be connected to each line with a maximum of 250 M-bus devices per line.

Moreover, up to 20 M-bus devices can be connected directly to terminals M1 and M2. Additional information on the M-bus web server terminals is available in section 'Connect web server and level converter, pg. 27.

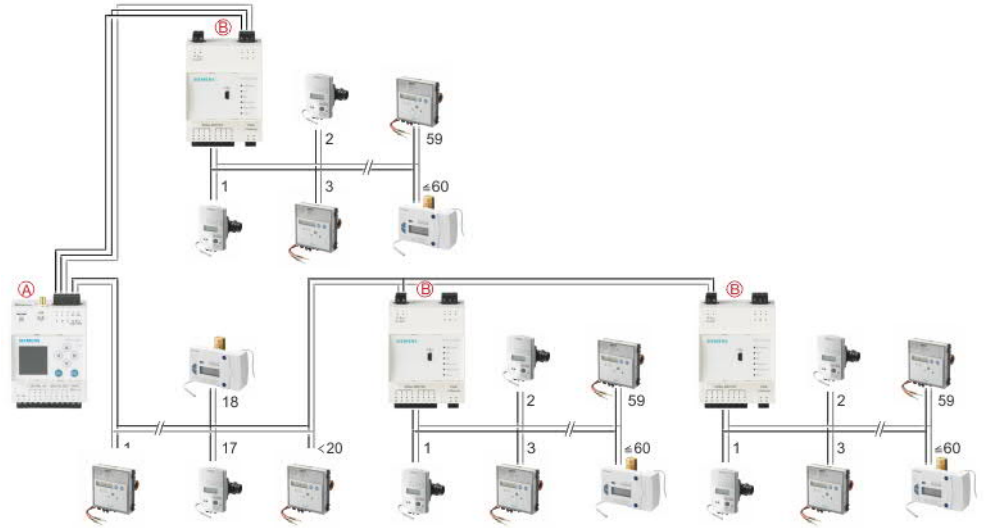

- A Web server as master
- B Level converter as slave

4.2.6 Web server with RF converters

The web server can be equipped with additional RF converters to extend the system up to 2,500 wireless devices. Communication between the web server and RF converters takes place over a mesh RF protocol (backbone network). A minimum of one M-bus web server and one RF converter is required to read out wireless devices. The backbone RF network can consist of a maximum of 23 RF converters. Communication between the RF converters and wireless devices takes place over the wireless M-bus protocol. The RF converter saves the consumption data from the devices in its environment, while forwarding the data to other RF converters, up to the web server (the other RF converters act as repeaters in this case).

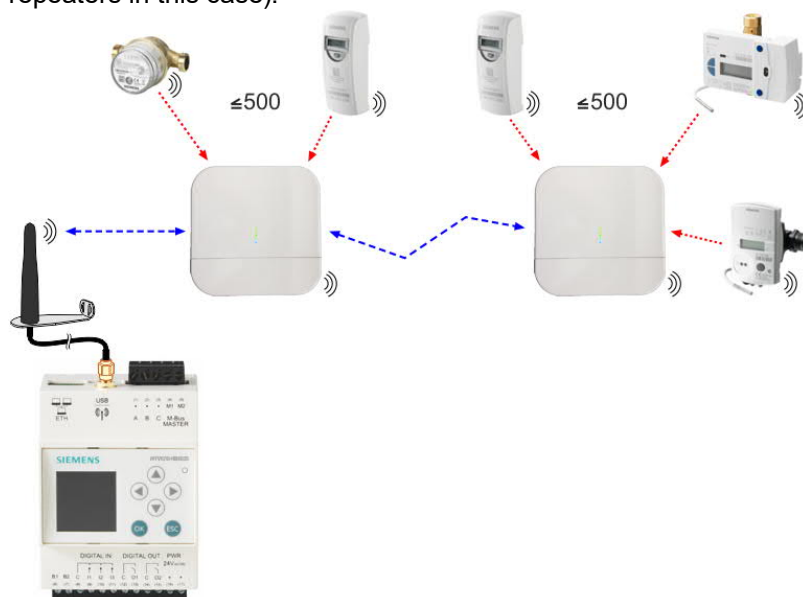

4.2.7 Combined plants

One web server can simultaneously read out up to 500 wired M-bus devices (250 per line) and up to 2,500 wireless devices.

Note

Different level converters (WTV531.., WTX631..) are permitted on the same plant and same line.

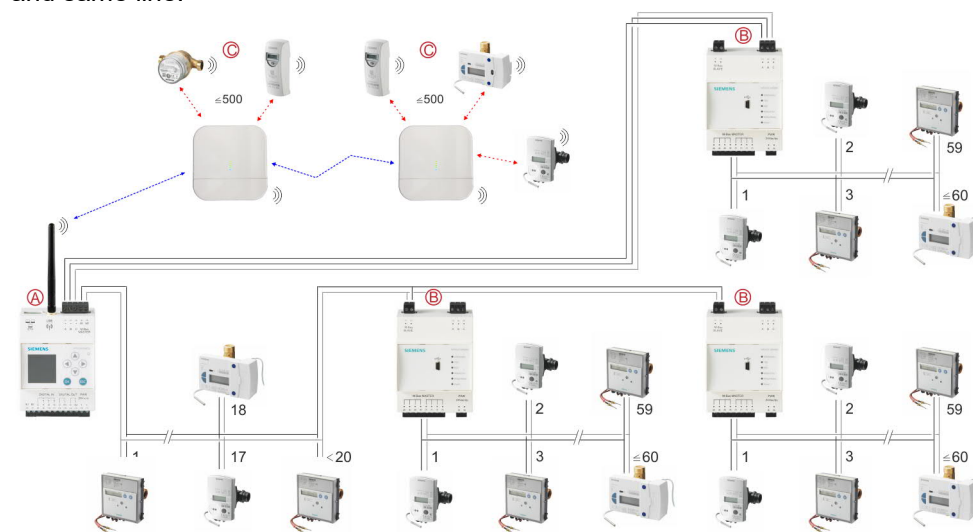

- A Web server as master
- B Level converter WTV531.. as slave
- C M-bus-RF converter as participant

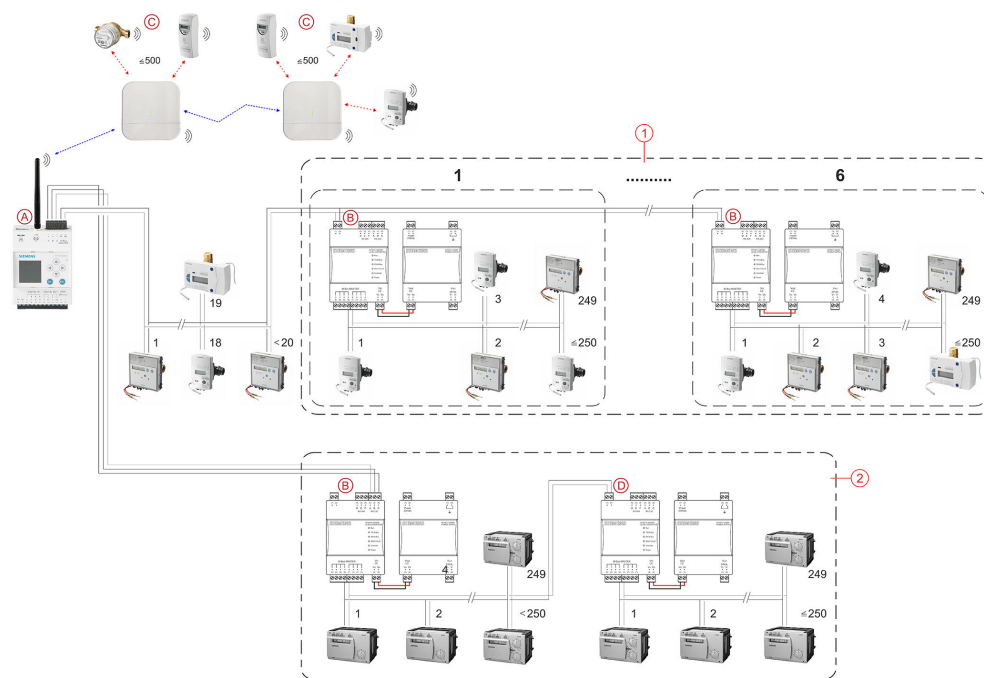

- A Web server as master
- B Level converter WTX631.. as slave
- C M-bus-RF converter as participant
- D Level converter (repeater) WTX631.. as slave
- 1 Parallel connection
- 2 Serial connection

4.2.8 Synco IC topology

After integrating the web server WTV676-HB6035 in the Synco IC cloud, billing data, trend data, and alarm messages can be uploaded and sent to various recipients. Multiple M-bus web servers as well as OZW web servers can be managed on one joint Synco IC account.

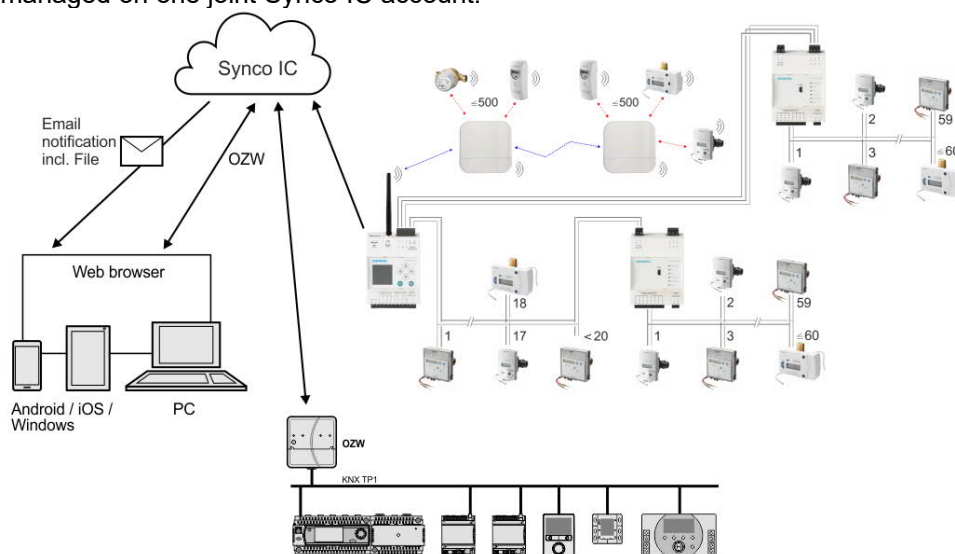

4.3 Readout of data

4.3.1 Readout of data via PC / Internet browser

A PC/Internet browser reads the data on all operation modes either locally over Ethernet or from anywhere over the Internet using a PC/Internet browser.

4.3.2 Mobile data readout over WLAN

To simplify on-site readout, the web server can also be readout using a mobile phone or tablet via WLAN and the readout data can be downloaded to the mobile device.

Additional information on enabling the WLAN connection on web server is available in section 'WLAN connection', page 59.

Additional information on mobile data readout is available in section 'Mobile' option', page 63.

4.4 Power supply

4.4.1 Level converter WTV531.., WTX631..

Please note when designing the power supply for the level converter, that M-bus devices require additional current of up to 20 mA when communicating.

For M-bus address conflicts during commissioning, multiple M-bus devices can draw power at the same time and it adds up.

The level converter limits power on the M-bus to a maximum of 200 mA.

Select an AC/DC 24 V power supply with at least 12 W and voltage tolerances as described in the technical data.

The level converter WTX631.. can also be used as the power supply for the M-bus web servers WTV676..

4.4.2 Web server

Select an AC/DC 24 V power supply with at least 14.5 / 15 VA and voltage tolerances as described in the technical data.

Note

DC 24 V can be tapped from the power supply WTX631.. The web server can be powered with this voltage without the need for a separate transformer.

4.4.3 RF converter

Select a power supply AC 100...240 V as described in the technical data.

4.4.3.1 Locating RF converters

The RF converter receives data from one or more wireless devices within a radio system per EN13757-4. The RF converter forwards the received data to the web server.

You can power the RF converter over a USB connection using an external battery ($\geq 5000\text{mAh}$; @5V; $\geq 1.5\text{A}$) to help in the search for the optimum location. The RF converter remains mobile during the scan and can be moved to the location with the best signal reception.

A flashing blue LED indicates that the location is unfavorable and there is no connection to the web server.

Once a favorable location has been found and a connection set up from the device to the web server via the RF converter, the blue LED stops flashing and the search for wireless devices begins.

The green LEDs only light up once a connection to the web server has been established. The number of green LEDs that are illuminated indicates the signal strength. When all four LEDs light up, you have a strong signal. The blue LED remains permanently illuminated.

The minimum distance between RF converters is 5 m. The RF converter must be at least 20 cm from the ceiling and the wall where it is mounted.

Note

4.5 M-bus

4.5.1 M-bus addressing

M-bus uses two addressing types to recognize and communicate with wired M-bus devices:

- Primary addressing:
Up to 250 primary addresses can be assigned per line to an M-bus system. The primary address is normally assigned during M-bus device commissioning.
- Secondary addressing:
Secondary addressing consists of 8 digits and permits the assignment of any number. In the default setting, the secondary address for a M-bus device matches the serial number issued by the device manufacturer. The assignment prevents address conflicts on the M-bus and permits addressing of more than 500 M-bus devices on a system.

4.5.2 Sizing the wired M-bus system

Allowable cable types:

- Shielded telephone cable 0.5 mm^2 (4 x 0.8 mm)
- NYM cable (1.5 mm^2)
- Maximum capacitive cable load of 152 nF/km

Bus expansion

If using cable with a cross-section of 0.6 mm², you must cut the information in half on "Maximum distance" and "Number of devices" from the following table.

Plant type	Maximum distance	Total cable length	Cable diameter	Number of devices (slaves)	Max. transmission rate
Small residential buildings	350 m	1000 m	0.8 mm ²	500 (250 per line)	9600 baud
Large residential buildings	350 m	4000 m	0.8 mm ²	500 (250 per line)	2400 baud
				64	9600 baud
Small developments	1000 m	4000 m	0.8 mm ²	64	2400 baud
Large developments	3000 m*	5000 m	1.5 mm ²	64	2400 baud
Direct vicinity	5000 m*	7000 m	1.5 mm ²	16	300 baud
Point-to-point connection	10000 m*	10000 m	1.5 mm ²	1	300 baud

*Shielded cabling required at a distance in excess of 1000 m (see EN13757-2 appendix E).

Signal specification

M-bus	Condition	Minimum	Typical	Maximum	Unit of measure
Number of unit M-bus loads	WTV531-GA5060	0		60	
	WTV676-HB6035	0		20	
	WTV631-GA0090	0		250	
Transfer rate	C _{Segment} ≤ 382 nF	300	2400	9600	Baud
Bus voltage	WTV531-GA5060	30	39	40	V
	WTV676-HB6035	24	40	42	V
Bus current	WTV531-GA5060	0		90	mA
	WTV676-HB6035	0		30	mA

5 Installation

Prerequisite

Connections between devices are based on the selected operating mode as illustrated in the sections below.

Important

 Do not connect power to the devices prior to installation!

5.1 Connecting multiple level converters (WTV531.., WTX631..)

To extend the M-bus, connect terminals (6) and (7) on the existing level converter (master) to terminals (1) and (2) on the additional level converter (slave).

Additional level converters are connected via slave terminals (1) and (2) with the same terminals on the previous level converter.

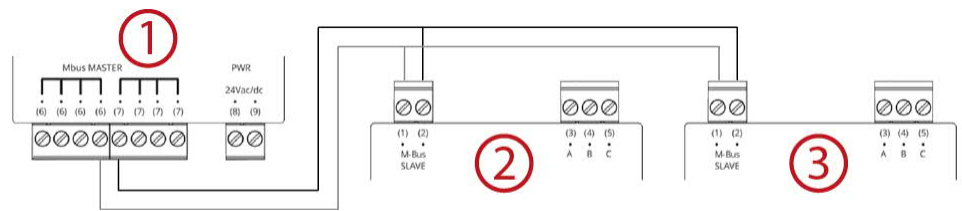

- 1 Level converter as master
- 2 Level converter as slave for additional M-bus devices
- 3 Level converter as slave for additional M-bus devices

5.2 Connect web server and level converter

Terminals (1) and (2) on the level converter are connected to line M1M2 on the M-bus web server. In addition, a maximum of 20 M-bus devices can be connected directly to terminals M1 and M2.

To connect the level converter to the M-bus web server online ABC, terminals A (3), B (4), and C (5) on the level converter are connected to terminals A (1), B (2), C (3) on the M-bus web server. M-bus devices cannot be connected directly to terminals A, B, C.

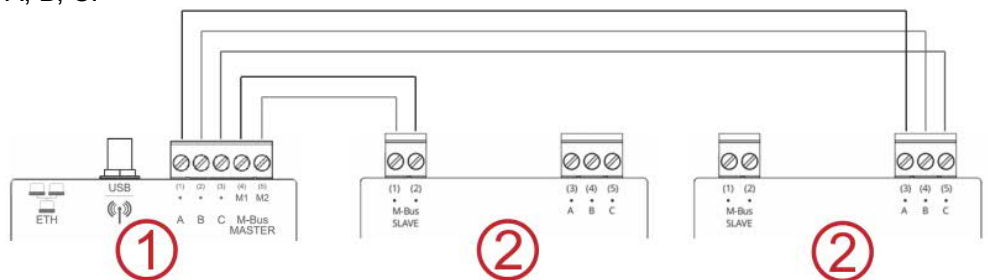

- 1 Web server as master for 20 devices
- 2 Level converter as slave for additional M-bus devices

5.3 Connect web server and RF converter

Install the supplied antenna to access the RF converter. The antenna can be connected either directly or using a cable (recommended). Additional information on installing the antenna is available in document A6V11157964. See Section "Reference documents", page 7.



5.4 Connect level converter to a PC

5.4.1 Level converter WTV531..

To connect the level converter to the ACT531 M-bus configuration and readout software, plug in a mini USB type B connector to the level converter and the USB connector to a PC with the installed ACT531 software. For additional information, see the ACT531 software documentation, section Reference documents, page 7

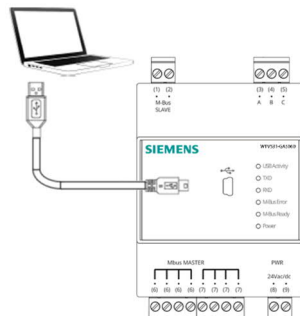

5.4.2 Level converter WTX631..

The level converter can be connected to a PC as master via interface RS-232 or RS-485 to read out device data.

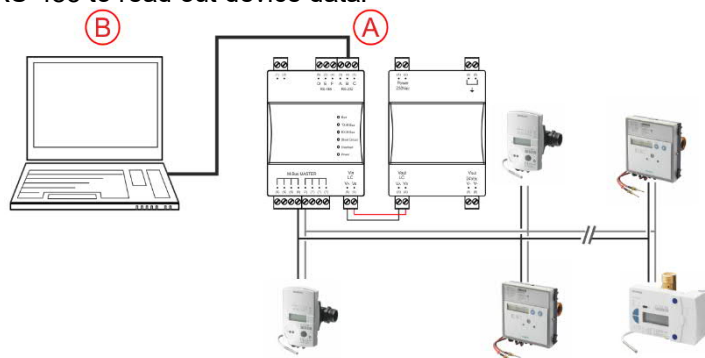

- A Level converter (interface RS232 or RS485)
- B PC or M-bus device

The TX Open module integrates M-bus devices via RS-232 or RS-485 interface to in the Desigo CC management platform. Additional information on the Desigo CC management platform is available in the Engineering guide 'Desigo TM TX Open, TX M-bus', document CM110572. See section 'Referenced documents', page 7.

Note

Level converter WTX631.. cannot be read out the device data with the ACT531 software.

5.5 Connect web server to PC

A network cable is used to connect the web server and PC/LAN. See Section "Connect web server to PC or LAN", page 39

5.6 Connect RF converter to PC

The mini USB type B connection on the RF converter connects to the USB interface on the PC with the installed ACT531 software. The RF converter is configured with the ACT531 M-bus configuration and readout software, version \geq 2.0. Additional information on the M-bus configuration and readout software is available in document A6V10844345, section Reference documents, page 7.

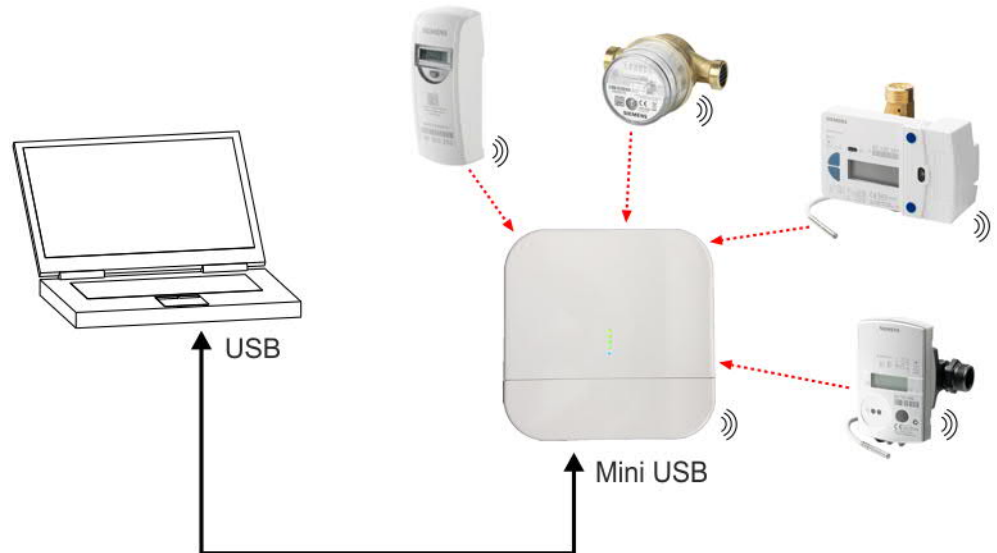

5.7 Connect M-bus devices to level converter

Up to 60 M-bus devices can be connected using terminals (6) and (7) on the level converter WTV531..., and up to 250 M-bus devices can be connected on the level converter WTX631...

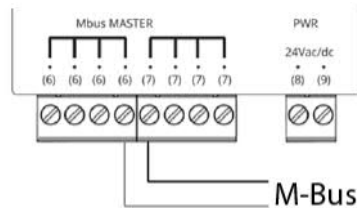

5.8 Connect M-bus devices to web server

Up to 20 devices can be connected directly to the web server. They are connected to terminals M1 (4) and M2 (5).

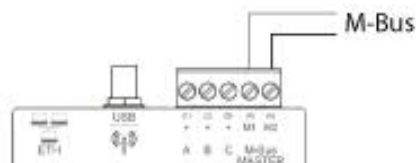

5.9 Connect wireless M-bus devices to the RF converter

All RF converters must be part of the same radio network (mesh network). Do not place the devices too far from one another on the same floor and avoid any larger barriers such as cement walls or metal construction. The distance between individual devices on different floors cannot exceed more than just a few devices.

5.10 Digital inputs on web server

Web server provides 3 digital inputs I1, I2, and I3 to connect potential-free contacts (e.g. switches, relays). The contacts are connected as follows:

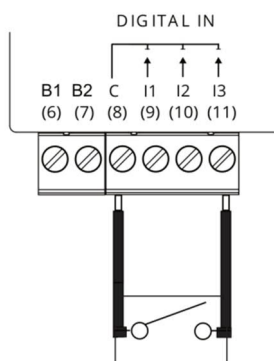

- Input I1:
Connect the external contact with terminals C (8) and I1 (9).
- Input I2:
Connect the external contact with terminals C (8) and I2 (10).
- Input I3:
Connect the external contact with terminals C (8) and I3 (11).

5.11 Digital outputs on web server

The web server has two relays that can be used as digital outputs. They can connect a load or be used as contacts to activate other systems. Terminals O1 (13) and O2 (15) can be controlled locally on the web server or remotely via the Internet.

Connect as follows to control, for example, a load:

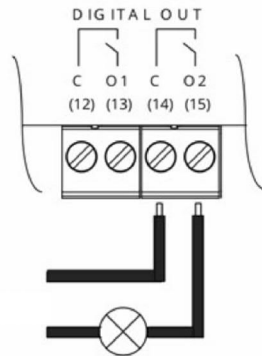

The load at the relay contacts may not exceed the following values:

- 5 A @ AC/DC 30 V (resistive load)
- 2 A @ AC/DC 30 V (inductive load $\cos\phi = 0.4$)

5.12 Web server access to Synco IC

Web server WTV676-HB6035 is required to access the M-bus web server (as of firmware version WTV676_WI-2.19_FW-2.4-16-2.3.bin). Connect the M-bus devices directly to the M-bus web server.

The following settings are required to transmit reports (billing files, trend files, and alarm messages) automatically to the cloud:

- Set up the automatic transmission of reports to the cloud on the web server
- Register the web server on the Synco IC portal using the activation key
- On the Synco IC portal, check the email notifications to send when a new report is loaded to the cloud

The following describes the individual steps.

5.12.1 Setup Synco IC reports

No reports are initially sent to the Synco IC cloud.

You must enable automatic report transmission to the cloud to automatically load reports to the cloud and distribute to recipients.

You can enter the settings either on the web server browser or locally on the display.

Browser view

In menu Export data > Automatic reporting, under Synco IC reports, select "Enable Synco IC reporting". See Section "Setup automatic reports", pg. 109.

Local display:

You can enable or disable automatic report transmission to the cloud in the "Settings" menu. See Section "Operating", pg. 49.

5.12.2 Enable web server in Synco IC

Change to the Synco IC portal to register the web server.

The Synco IC portal is located at: <https://www.siemens-syncoic.com/>.

Enter your email address and web server activation key on the Synco IC portal to register.

You can view the activation key either on the web server browser or locally on the display.

Browser view

The activation key is available in the menu "Export data" > "Automatic reports" under "Setup Synco IC reports". See Section "Setup automatic reports", pg. 109.

Local display:

The activation key is available on the local display of the web server in the menu "Info" > "Activation key". See Section "Operating", pg. 49.

Detailed information on integrating the web server via the Synco IC portal is available in Section Web server integration in Synco IC, pg. 44.

5.12.3 Configure email notification in the Synco IC portal

Only the latest reports (billing files, trend files, and alarm messages) are saved in Synco IC. The existing report in Synco IC is overwritten each time a new report is uploaded and is no longer available in the cloud.

The reports are uploaded to Synco IC per the customized settings (see Section "Setup automatic reports", pg. 109). An email notification is sent to predefined recipients as soon as a new report is uploaded to the cloud.

You can configure the recipients of an email notification in the Synco IC portal as well as whether to attach the reports to the email (or not).

Note

The settings for the alarms in the web server menu "Settings > System" have no influence on the Synco IC alarm notifications.

Additional information on setting up alarm notifications is available in the Synco IC user guide, document A6V10500249. See Section "Reference documents", pg. 7.

6 Level converter commissioning

Prerequisites

Ensure the following prior to commissioning the level converter:

- The electrical connection must be fused (non-renewable fuse or circuit breaker)
- The power supply must be at the device's rated voltage.
- The power supply must be sufficient to operate the device.

Note level converter WTV531..

Commissioning commences once power is connected to the level converter. Additional settings are also available if using the ACT531 software.

Operation and any errors are indicated with LEDs on the front side.

6.1 Display elements

6.1.1 Level converter WTV531..

- USBActivity** The level converter has six LEDs on the front side for indicating the operating state.
- TXD**
- RXD**
- M-Bus Error**
- M-Bus Ready**
- Power**

USB Activity

The LED indicates the USB interface connection state.

- Flashes 2 x → The device is ready to connect to a PC using a mini USB-B cable.
- Flashes 5 x → The device is connected to and correctly recognized by the PC.

TXD

The LED indicates the transmission state on the M-bus master (terminals 6 and 7).

- On → Data transmitting.
- Off → No data transmission.

RXD

The LED indicates the receive state on the M-bus master (terminals 6 and 7).

- On → Data is being received.
- Off → No data is being received.

M-bus Error

The LED indicates the state of the M-bus power supply.

- On → Bus overload (short circuit or too many devices on the bus).
- Off → No faults recognized.

M-bus Ready

The LED indicates that bus power is correct and there are no anomalies.

- On → M-bus power is sufficient for trouble-free operation.
- Off → M-bus power is insufficient for trouble-free operation.

Power

The LED indicates the state of the level converter power supply.

- On → The device power supply is correct.
- Off → Device power is not correct or unavailable.

6.1.2 Level converter WTX631..

- Run
- TX M-Bus
- RX M-Bus
- Short Circuit
- Overload
- Power

The level converter has six LEDs on the front side for indicating the operating state.

Run	<p>The (green) LED indicates the operational state of the device.</p> <ul style="list-style-type: none">• Flashes at 1 Hz (slowly) → The device functions are set up. No communication.• Flashes at 10 Hz (fast) → Device update pending.• On → The device is operational.
TX M-bus	<p>The (green) LED indicates the state of data transmission on the M-bus network (terminals 9 and 10).</p> <ul style="list-style-type: none">• On → Data is transmitting.• Off → No data is transmitting.
RX M-bus	<p>The (orange) LED indicates the state of the data reception on the M-bus network (terminals 6 and 7).</p> <ul style="list-style-type: none">• On → Data is being received.• Off → No data is being received.
Short circuit	<p>The (red) LED indicates a short circuit on the bus, very high traffic or collision rate</p>
Overload	<p>The (orange) LED indicates bus load that may prevent correct operation.</p> <ul style="list-style-type: none">• On → Bus overload that may prevent correct operation.• Off → No bus overload recognized.
Power	<p>The (green) LED indicates the state of power supply on the level converter.</p> <ul style="list-style-type: none">• On → The device power supply is available.• Off → The device power supply is not correct or unavailable.

6.2 Troubleshooting the level converter

The device does not switch on. The **Power** LED is off.

- Using a multimeter, check whether the required operating voltage of 24 V AC or DC is available at terminals (8) and (9).

The **M-bus Error** LED is on

- Check M-bus wiring. There is a bus overload due to a short circuit between the bus cables or too many M-bus devices are connected.

The **M-Bus Ready** LED is switched off.

- Using a multimeter, whether M-bus power is available between terminals (6) and (7) between DC 24 V and 42 V.
- Check the M-bus for short circuits if voltage is below that level.

The M-bus web server connected to the level converter does not recognize a device (or not all devices).

- Make sure the wiring is correct between the M-bus web server and Terminal D of the level converter.
- Make sure that the level converter connected via USB to the PC is not using the bus.
- Using a multimeter, check whether the M-bus voltage on the unrecognized devices is between 24 V and 42 V DC.
- Ensure that the communication settings on the M-bus web server or the software are compatible with the devices (transmission rate, addressing)

Connected devices do not communicate when the level converter is used as a repeater.

- Check whether M-bus is connected with terminal C on the level converter.
- Make sure that there is no USB cable connected to the level converter.
- Check operating and bus voltage and that the **M-bus Error** LED is off.

6.3 Level converter firmware WTV531..

You can use the ACT531 software to read the current firmware version on the level converter and update as needed.

For additional information, see the ACT531 documentation.

7 Commission RF converters

- Determine the best location for the RF converter. The RF converter can be powered by an external battery (using its USB connection) to search for the optimum location. Additional information is available in Section "Locating RF converters", page 25.
- Ensure that all RF converters belong to the same radio network.
- Ensure that all RF converters have the same Mesh ID and same channel ID within a radio network. You do not need to change the Mesh ID if the blue LED flashes for more than five minutes. You must change the Mesh ID if the blue LED is on continuously after just a few minutes. The RF converter is configured with the ACT531 M-bus configuration and readout software, version ≥ 2.0 , or locally using the S1 and S2 buttons. Additional information on the M-bus configuration and readout software is available in document A6V10844345. See section "Reference documents", page 7.
- The M-bus operation mode (C+T/S-Mode) must be the same for both the RF converter and the meters on the radio network. Mount the RF converter on the wall. Additional information on mounting is available in document A6V11135905. See Section Reference documents, page 7.

7.1 Data security and encryption

The radio network system supports devices with AES128 encryption

7.2 Troubleshooting the RF converter

The RF converter does not switch on.

- Ensure that the required operating voltage (AC 100...240 V) is connected.
- Check the quality of the USB cable if using the USB connection or whether the PC is able to supply a current of 500 mA.

The blue LED flashes.

- Ensure that the web server is switched on and the antenna is connected and oriented to receive radio signals.
- Ensure that the distance between the web server and the RF converters is at least 5 meters. The minimum distance between individual RF converters is also 5 meters.
- Use the ACT531 software to ensure that the mesh network ID and the channel ID are correct and match the mesh network ID and channel ID of the web server. Further information about changing the mesh ID and channel ID is available in document A6V10844345. See section "Reference documents", page 7.

Does not recognize all meters.

- Ensure that the unrecognized devices are not located too far from the RF converter and that the radio signal is not too weakened by cement or metal walls.
- Ensure that the unrecognized devices are loaded to the web server list and that contact to the wireless M-bus devices, recognized by the web server, is not interrupted.
- Please note that some wireless M-bus devices only transmit their data at intervals of multiple hours.
- Use the web interface or the ACT531 software to ensure that the mesh network is operational.

The blue LED doesn't stop flashing (flashing frequency > 1x per second).

- If the LED flashes 1x, this indicates a RAM error.
- If the LED flashes 2x, this indicates an M-bus RF module error.
- If the LED flashes 3x, this indicates an error in the RF module of the mesh network.
- If the LED flashes 4x, this indicates a flash memory error.
- If the LED flashes 5x, this indicates a realtime clock error.

8 Web server commissioning

Prerequisites

Ensure the following prior to commissioning the web server:

- The electrical connection must be fused (fuse or circuit breaker)
- The power supply must be at the device's rated voltage.
- The power supply must be sufficient to operate the device.
- The router (if available) must be configured as per the description.
- The network plug must be wired correctly to exchange data and connected to the ETH connection on the web server
- In the event a level converter is connected to the web server, connect it as a slave on the web server's master output.

8.1 Connect web server to PC or LAN

Web server has an Ethernet connection to directly connect to a local PC or connection to a PC over LAN.

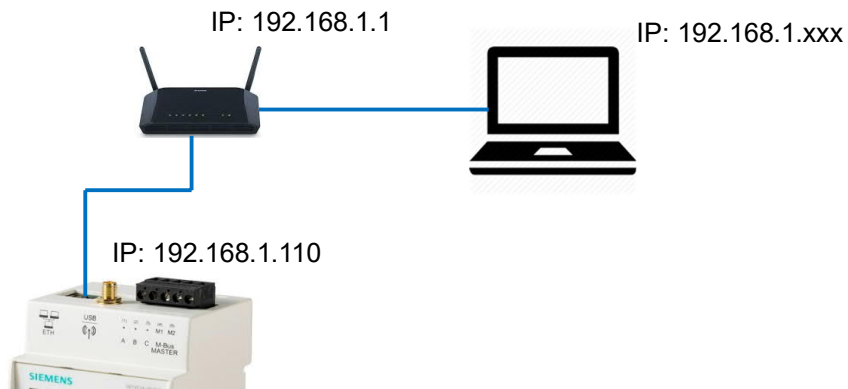

Default settings for connecting to the web server:

IP address: 192.168.1.110
Network mask: 255.255.255.0
IP address assignment: Static

Proceed as follows to connect a PC to web server:

- Use an Ethernet cable per standard T568A or T568B (1:1 or crossover) to connect web server with a PC (directly) or LAN. If using the LAN, also connect the PC to the LAN.
- Check whether an IP address is displayed on web server in menu **System info**, under **LAN Status**.

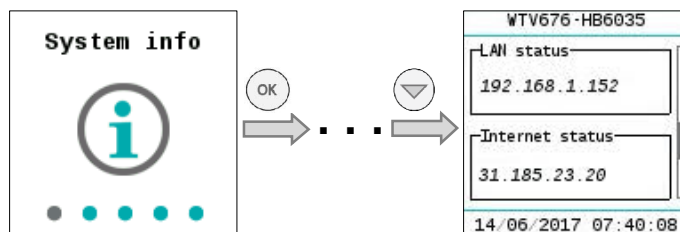

Connection over LAN	Use a DHCP server for dynamic IP address or a fixed IP address if the PC and web server are integrated on an existing LAN. Contact your network administrator about the fixed or dynamic IP address to be used. You can change the LAN settings via the local operation of the web server. Details see section 10.
Direct PC connection	Configure the IP address on the PC network settings or web server so that the PC and web server are on the same network. In the example above, the PC must have a static IP address 192.168.1.xxx (with xxx of 1 and 254, but NOT 110) and the network mask must be set to 255.255.255.0.
IP address ranges	The following IP addresses are reserved for private networks: <ul style="list-style-type: none"> • Class A: 10.0.0.0–10.255.255.255. • Class B: 172.16.0.0–172.31.255.255. • Class C: 192.168.0.0–192.168.255.255 (typical for home networks).
Access to web server	To access web server, enter the web server IP address (e.g. https://192.168.1.110) in the browser (Chrome, Safari, Firefox). For additional information on web server settings and operation over the browser, see section 12. Additional information on router configuration is available in the Appendix, page 123.

8.2 WTV remote access

WTV remote access	<p>Web server WTV676.. includes a remote access service to simplify remote access. Only one Internet access is required to connect to the web server via Ethernet cable to easily operate the web server remotely.</p> <p>The URL for remote access consists of</p> <ul style="list-style-type: none"> • The WTV remote access service (Siemens URL): www.wtv676.siemens-info.com • The serial number of the web server: evxxxxxx <p>Example: www.wtv676.siemens-info.com/ev0000001</p> <p>The following settings must be modified:</p> <ul style="list-style-type: none"> • Network settings • Email configuration (optional) • Dynamic DNS (optional) <p>Additional information on network settings, email configuration, and dynamic DNS is available in section 'Network', page 85.</p>
Note	 WTV remote access is possible as of web service FW version F. All web servers WTV676.. can be updated with FW version F.
Direct access to web server	Enter the URL for the WTV remote access to connect the desktop to web server (home page). Log on the home page of the web server with your username and password.
Access via Synco IC (available soon)	You can access the home page of the web server directly via menu 'Web access' if web server is already connected to Synco IC. Log on the home page of the web server with your username and password.

8.3 M-bus commissioning on web server

After installation and after all connections are established, the M-bus is commissioned as per the following steps:

Check M-bus

On the level converter, check that the **M-bus Ready** LED is on and the **M-Bus Error** LED is off.

First time log in

You must set the web server language the first time web server is activated. The following languages are currently available:

- German
- English
- Italian
- French
- Dutch

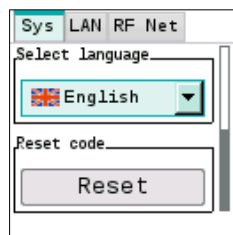



Notes

i The language selected during the initial login applies to both the display as well as the software user interface to web server. You can change the language after initial login for the display and web server independently. The display language can be changed anytime on the display. See section "Select default operating language (Display)", page 48.

You can change the language for the web server at any time in the software user interface.

See Section 'Select the web server language (software interface)', page 65.

Access code

Define an 8-digit access code. Use the  and  navigation buttons to set a number from 0...9. Press **OK** to go to the next digit. You must reenter the 8-digit access code to confirm it.

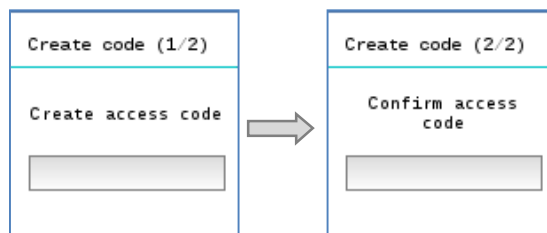

Change access code

The access code can be changed at any time to protect against unauthorized access.

See section "Change access code", page 49.

Start meter search

In the **Meter search** main menu, start the search for connected M-bus devices. Detailed information on the meter search workflow is available in section "Meter search", page 97.

Continue settings on web server	At the conclusion of the meter search, we recommend accessing the web server via the Internet browser to conclude the configuration. You can enter plant data and other settings via the Internet browser. For access to web server, see section "Connect web server to PC or LAN", page 39.
Enter meter name	Assign each device a unique name, e.g. "Apartment 1", "Warehouse", "Hot water" to simplify evaluation of reports with consumption data or device information. See section Settings / Wired devices / Device settings , page 89.
Enter plant data	Plant data includes information on user, address, etc. The data is displayed in the report header and permits clear assignment of the measured data to a plant. See section Settings / System / Plant data , page 79.
Email settings	Web server can email you reports, events, messages, anomalies, and errors. See section Export data / Automatic reports / Email address settings , page 85.

8.4 Commission RF converters on web server

Enter device names to the wireless devices

Assign each device a clear and unique name to each meter, for example, "Apartment 1", "Basement", "Hot water" to simplify the evaluation of reports on consumption data or device information on the web server.

See Section **Settings / Wireless devices / Device settings**. Page 100.

8.5 Web server troubleshooting

The device does not switch on. The green LED is off.

- Using a multimeter, check whether the required operating voltage AC/DC 24 V +/- 10 % is available between terminals (15) and (16).

The display is switched off.

- The display switches off automatically after 10 minutes. Press any button to switch on the display.

The web server does not recognize any devices.

- Check to ensure the wiring is correct between the web server and connected M-bus devices.
- Check to ensure the wiring is correct between the web server and the level converters.
- Check M-bus wiring for short circuits.

The web server does not recognize all M-bus devices.

- Check to ensure the wiring is correct between the web server and unrecognized devices.
- Using a multimeter, check whether the bus voltage on the unrecognized devices is between DC 24 V and 42 V.
- Ensure that the communication settings on the web server are compatible with the M-bus devices (transmission rate, addressing)
- Check to ensure that the number of connected M-bus devices does not exceed the maximum permitted amount.

The web server does not recognize all radio devices.

- Ensure that the unrecognized devices are not located too far from the web server and that the radio signal is not too weakened by cement or metal walls
- Ensure that the unrecognized devices are loaded to the web server list and that contact to the wireless M-bus devices, recognized by the web server, is not interrupted.
- Please note that some wireless M-bus devices only transmit their data at intervals of multiple hours
- Use the web interface or the ACT531 software to ensure that the mesh network is operational.

No connection with the web server.

- Check the PC network address. The web server uses an IP address 192.168.1.110 as the default. As a result, the PC must have an IP address of 192.168.1.xxx (with xxx not equal to 110).
- Ensure that a firewall is not blocking TCP/IP Port 80 or 443.
- Please contact your local IT administrator for excluding network problems

8.6 Web server integration in Synco IC

The web server is registered in the cloud after entering the activation key for the M-bus web server WTV676 in the Synco IC portal.

This billing data, trend data, and alarm messages (reports) is transmitted to Synco IC per customized settings as well as the distribution of information to the corresponding customers via email. You must select "Enable Synco IC reports" check box on the web server. Additional information on the automatic transmission of Synco IC reports is available in Section "Setup automatic reports", as of pg. 109.

8.6.1 Setup access

Registration is required for the first-time use of the Synco IC portal. An email address and activation key for web server must be entered to register. Additional information on the activation key is available in Section "Enable web server in Synco IC", pg. 33.

After registration, you must enter a password for future access to the portal. Additional data can be entered on the user and plant. The Synco IC-Portal is located at: <https://www.siemens-syncoic.com/>.

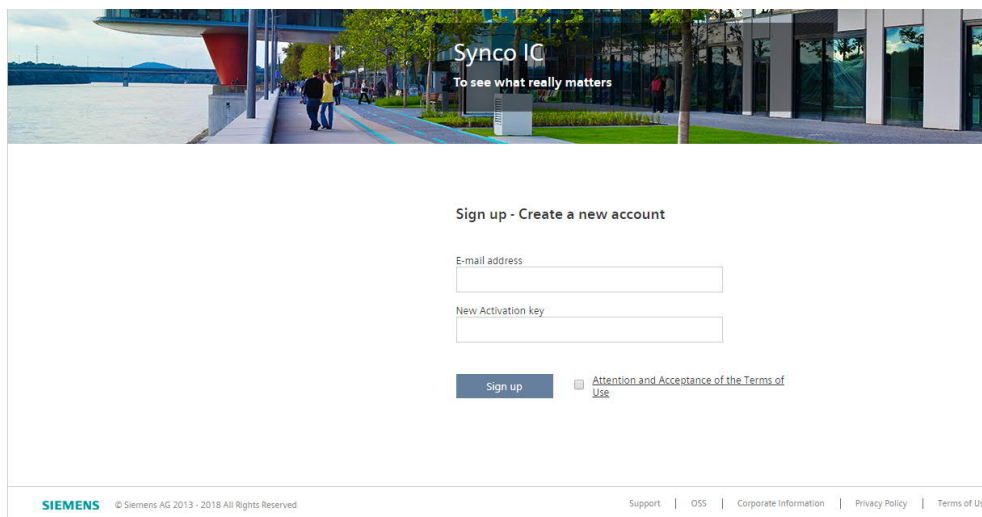

8.6.2 Activate plant

Activate your plant in the Synco IC portal, under the "Administration" menu. Additional information on activation and entering plant data is available in the Synco IC User's Guide, document A6V10500249. See Section "Reference documents", pg. 7.

9 Level converter operation

9.1 Level converter WTV531..

The level converter WTV531.. has no operating elements.
Any desired changes can be made using the ACT531 software.

9.2 Level converter WTX631..

The level converter WTX631.. has no operating elements.
It can be connected via RS-232- or RS-485 interface and connected to a PC. The
firmware can also be updated via the RS-232 interface

10 RF converter operation

The RF converter consists of three housing components. The base, mounted on the wall (1); the removable cover (2), and the cable entry (3).

The RF converter operating elements for the network are located in the lower part in the cable entry (3).

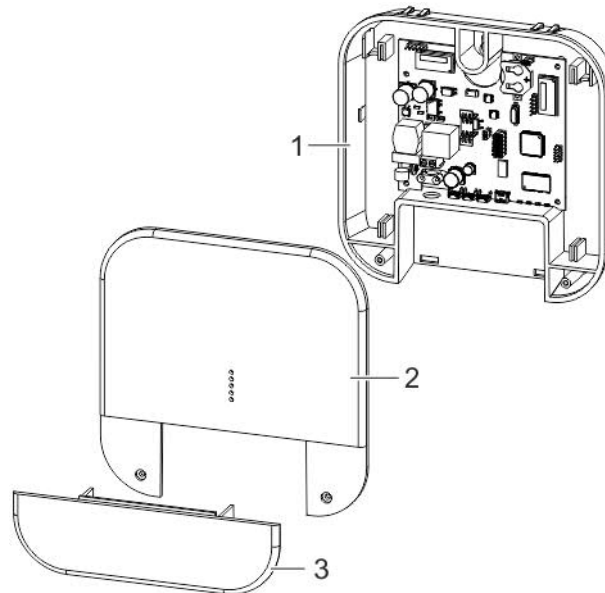

The removable cover has the following LEDs.

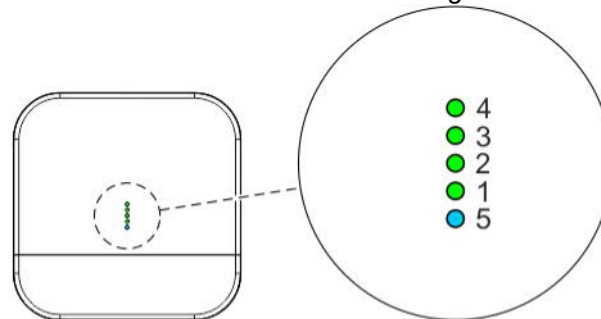

- | | |
|---------------|---------------|
| 1 Green LED 1 | 2 Green LED 2 |
| 3 Green LED 3 | 4 Green LED 4 |
| 5 Blue LED | |

The cover for the cable entry has the following connections and buttons.

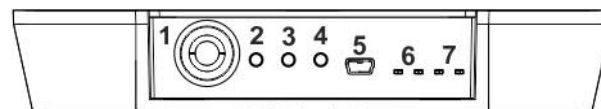

- | | |
|------------------------------------|--------------------------|
| 1 Power (AC 100..240 V) | 2 Local settings S1 |
| 3 Local settings S2 | 4 Reset button |
| 5 USB connection | 6 LED mesh network TX-RX |
| 7 LED wireless M-bus-network TX-RX | |

10.1 Change mesh ID

Change the mesh ID if the blue LED on the RF converter is permanently illuminated after installation and the web server is not switched on.

Proceed as follows:

- Press buttons 2 and 3 at the same time for a few seconds. As soon you let go of the buttons, one or all the green LEDs start flashing.

Note



For a mesh ID ≥ 5 , all the green LEDs flash simultaneously. Otherwise, only the corresponding green LED flashes. For example, LED 1 flashes for a Mesh ID = 1.

- Press button 3 for at least a second to change the mesh ID. The corresponding green LED is on permanently as soon as the mesh ID is changed.
- Press buttons 2 and 3 at the same time for more than a second to save the changes.
- Press button 2 to reject the changes.

11 Web server operation on the device

11.1 Select default operating language

The language set on the display is the default language.

You can set the default operating language directly on the display. After entering the password, you can select the language on the main menu at **Settings / System / Select language** by pressing the  and  buttons.

The following languages are available:

- English
- German
- Italian
- French
- Dutch

Each time the language is set or changed on the display, it remains the default language until the next change.

The default language is used on the following:

- Display functions
- Web server default language for the login
- Automatic reports on all web servers







Important



The language set locally on the web server is also used for sending emails and to generate reports and alarm notifications. It is very important that the language is set correctly locally on web server during commissioning.

11.2 Buttons

Web server has six buttons to navigate menus on the display. The button functions are based on the displayed menu.

	<ul style="list-style-type: none">• Confirm a field or a set value• Access to the main or sub-menu.
	<ul style="list-style-type: none">• Cancel a field selection or value.• Return from a sub-menu to a main menu.
	<ul style="list-style-type: none">• Go to previous main menu or sub-menu.• Move cursor to the left.
	<ul style="list-style-type: none">• Go to next main menu or sub-menu.• Move cursor to the right.
	<ul style="list-style-type: none">• Scroll up one page• Select / switch from letters A...Z and digits 0...9.
	<ul style="list-style-type: none">• Scroll down one page• Select / switch from letters A...Z and digits 0...9.

11.3 Operating

Measured data and basic settings are displayed on a color display. The display switches off automatically to save energy after 10 minutes.

Access code entry

Press a navigation button to switch on the display. The display to enter the access code opens.

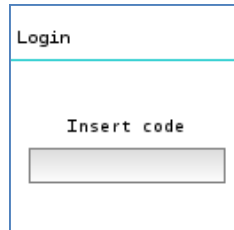

Enter the access code. The cursor flashes at the current position. Select individual numbers using the arrow keys \uparrow and \downarrow and confirm with the **OK** button. The cursor goes to the next position on the 8-digit access code.

Change access code

For security reasons, you can change the local access code on the web server at any time to prevent unauthorized access to the web server on the local display.

The access code on the web server is changed as follows:

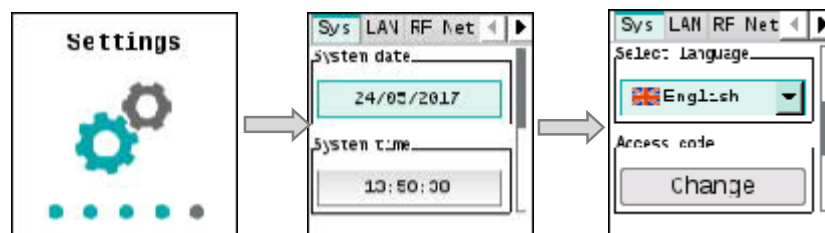

Select **Settings / System / Reset code** and press the **OK** button to reset the access code.

The current access code must be entered before you can enter and confirm the new code.

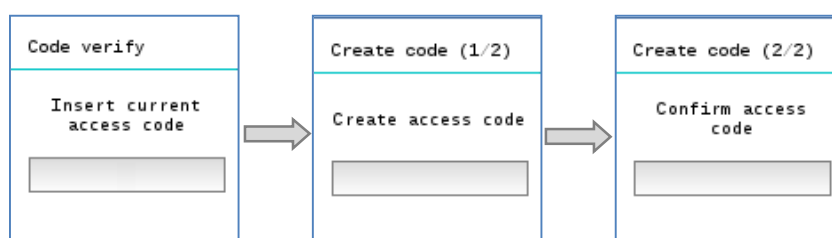

The display changes automatically to the **System info** main menu once the access code is changed.

The code must be entered again if an incorrect access code is entered or the new access code does not match the confirmation. There is no limit to the number of attempts.

Reset access code

In the event you are unable to access the local display using the access code, you can reset the access code via web browser as long as you know your login data for the web browser.
Additional information on resetting the local access code via web browser is available in section 'Settings', 'System', pg. 79.

Important



For security reasons, define a new access code locally on the web server as soon as possible after a reset.

Reset user account

You can reset the user account over the local display if you have forgotten the login data for web server access via web browser.

Select 'Settings' > 'System' > 'User account' and preset 'Reset' to reset the existing user account.

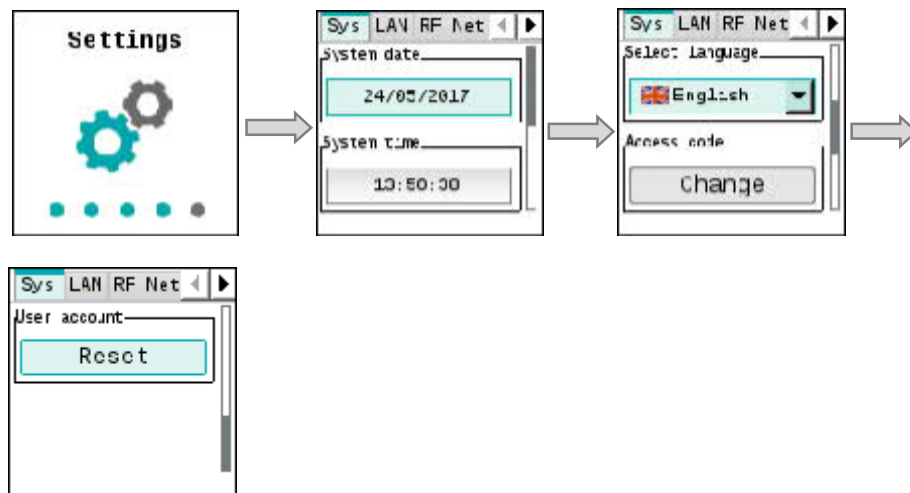

You must repeat the initial registration process after a reset. For security reasons, you are requested to reenter all the user account data as is the case for an initial registration via web browser.
Additional information on registration is available in section 'Registration & login', pg. 61.

Note



No plant data is lost when resetting the user account.

Main menu

The main menu displays after correctly entering the access code. It consists of five pages: **System info**, **Wire meters**, **Wired search**, **Search RF** and **Settings**.

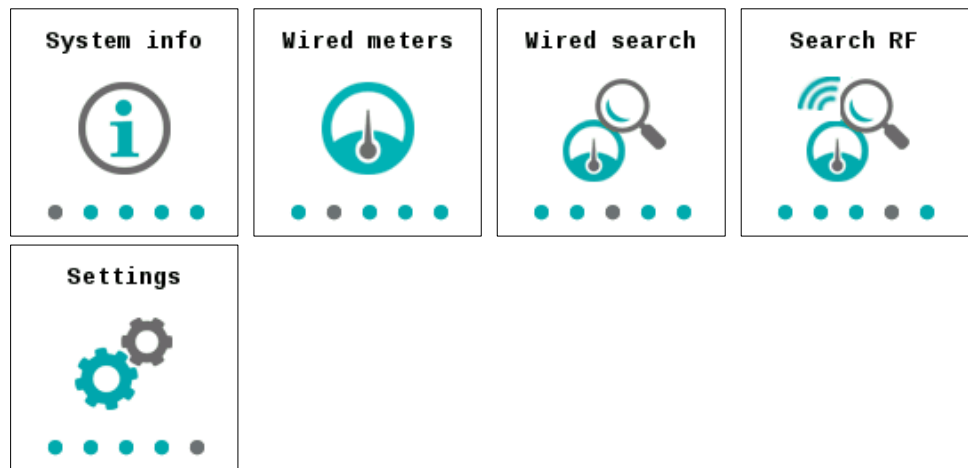

System info	Includes information on web server and connection status and to the activation key.
Wired meters	Displays the list of connected M-bus devices and makes it possible to display the data.
Wired search	Starts the search for connected device as per the last saved changes.
Search RF	Starts the search for RF devices using the last saved settings.
Settings	Includes some settings for both the web server and Synco IC.

System info menu

Select the **System info** main menu and press the **OK** button to go to the sub-menu.



- Plant name
- Serial number (required for support calls).
- LCD UI Version (local UI version)
- M-bus firmware version
- LAN connection status and IP address (if connection is available).
- Internet connection status and public IP address for external access (if connection is available).
- Input status (indicates the status of the three inputs)
- Output status (indicates the status of the two relay outputs)

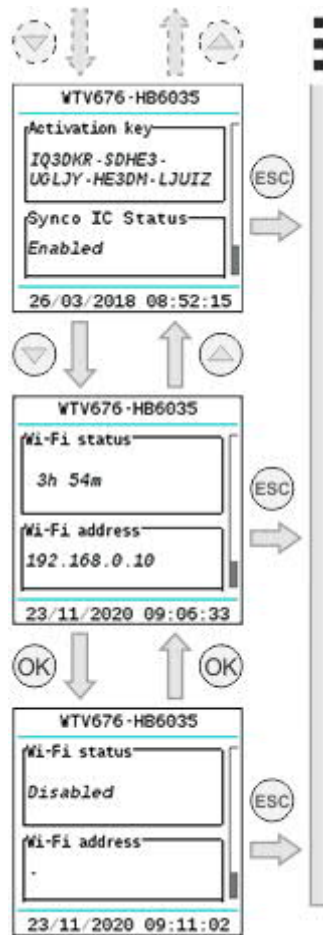

- Activation key for Synco IC
- Synco IC status
- WLAN status (displays the remaining time for the WLAN connection)
- WLAN address (displays the WLAN address, if active)
- WLAN status (Disable connection)

Wired meters menu

Select the Wired meters main menu and press **OK** to go to the sub menus

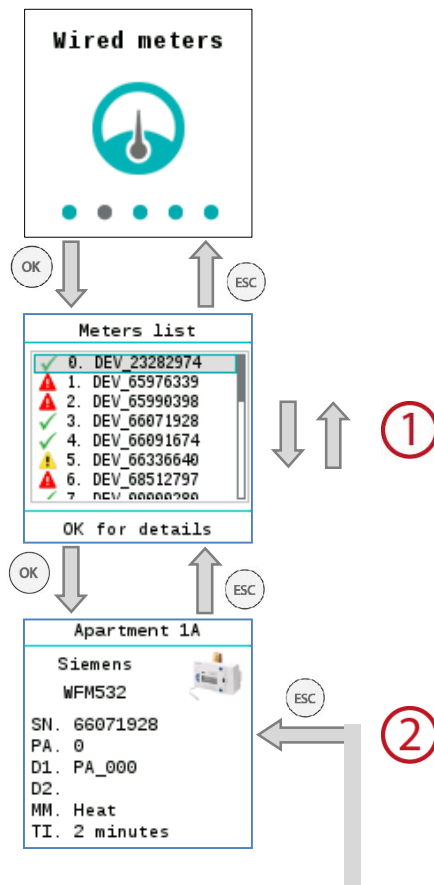

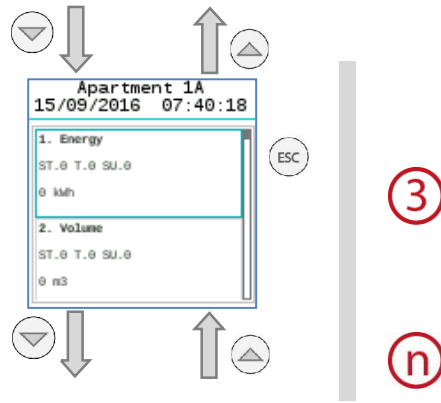

- ① List of saved meters. Each meter is identified by the first 8 digits of the serial number (e.g. 05434563).
The following symbols are displayed in the first column:
 - ✓ OK: The last readout was successful.
 - ⚠ Device error: An error was reported to the web server via M-bus.
 - 🚫 Communications error: No communications with the device.
 You can navigate through the list with the ⬆ and ⬇ navigation buttons. Press **OK** to go to the data for the selected meter.
- ② The first panel provides general information on the selected meter, including the complete fabrication number/secondary address of the meter (SN), primary address (PA), designation (D1, D2), medium (MM) and readout frequency (TI).
- ③ Displays the values from the last meter readout, if available. The ⬆ and ⬇ navigation buttons take you to additional meter fields for this readout time.
- ④ The following graphic explains in detail the display setup for meter fields.

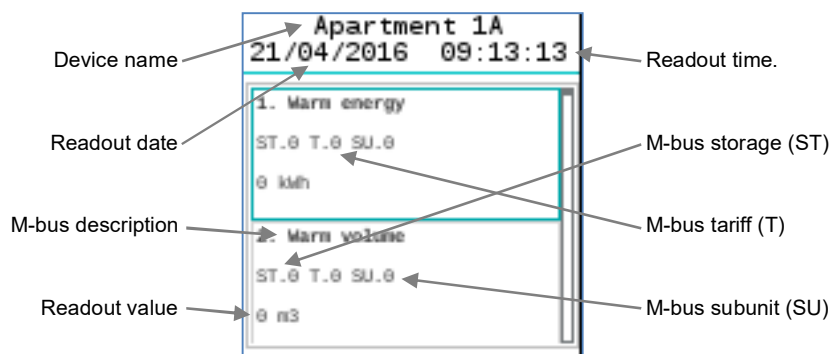

Important

⚠ The display only displays meter fields where the option **Display data** is selected. The setting is selected over web operation in the menu **Settings / Wired devices / Device settings / Meter data settings / Data point settings** (see page 89 et seq.).

Device name The setting is selected over web operation in the menu **Settings / Wired devices / Device settings / Meter data settings / Data point settings** (see page 89 et seq.).

Readout date Displays the date of the meter readout.

Readout time	Displays the time of the meter readout.
M-bus description	Displays the field description as per the M-bus protocol.
M-bus storage:	Displays the storage number of the displayed M-bus data point. See the meter documentation for additional information.
M-bus tariff	Displays the tariff number of the displayed M-bus data point. See the meter documentation for additional information.
M-bus subunit	Displays the number of the subunit for the M-bus data point. See the meter documentation for additional information.
Readout value	Displays the value with unit at the time of the meter readout.

Wired search menu

In the **Wired search** menu, press **OK** to start a scan for connected meters. The default search criteria are:

- Scan speed: 2400 bps
- Scan type: Secondary address

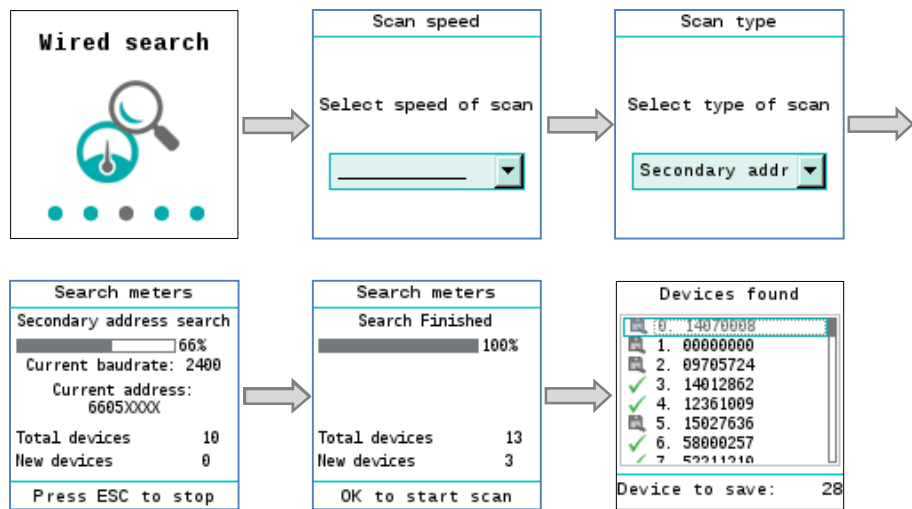

Scan speed

Select the baud rate used by web server to scan for meters:

300 bps and 2,400 bps / 300 bps / 600 bps / 1,200 bps / 2,400 bps / 4,800 bps / 9,600 bps

Scan type

Select the M-bus addressing type used in the scan:
 Primary + secondary address / Primary address / Secondary address

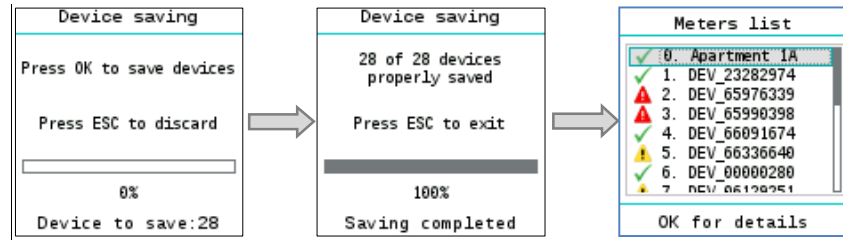

Check meters and save

A list of devices found is displayed after the meter scan is finished. Press **OK** to save all newly found meters and add them to the device list. The **ESC** button does not add the newly found meters to the device list. To edit meter settings over web operation, see menu **Settings / Wired devices / Device settings** (see page 89 et seq.).

RF search menu

Select the **RF search** main menu and press **OK** to start the search for RF devices.

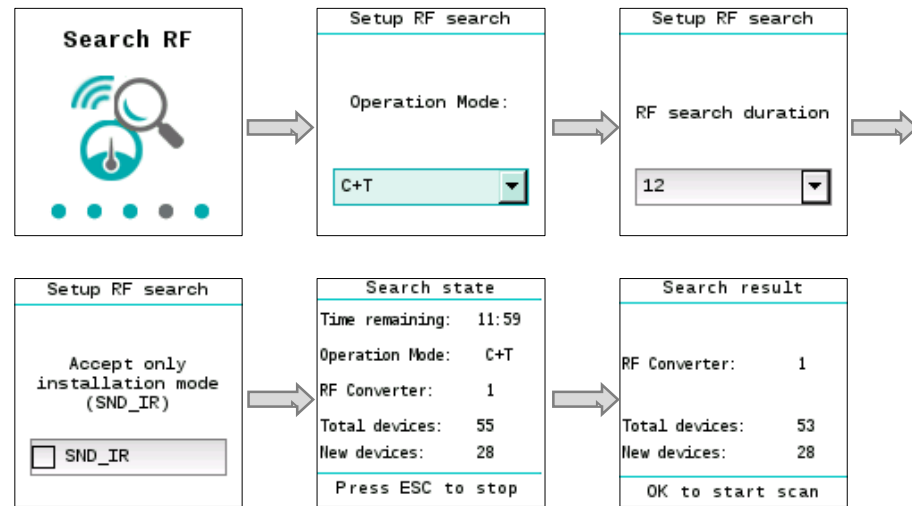

Operation mode

Select the operation mode. Ensure that the operation mode for M-bus (C+T/S-mode) is the same for both the RF converter as well as the devices on the RF network. The following values are available: S, T, C+T, C+T & S.

RF search duration

Select the duration of the search. Values 1 to 24 are available.

Installation mode

You can limit the search and only display devices in installation mode by selecting **SND_TR: Function**.

Settings menu

The **Settings** menu has three sub-menus:

- System
 - LAN
 - RF network
 - Synco IC
- You can navigate between the submenus with the ◀ and ▶ navigation buttons.
- You can navigate within the submenus with the ▲ and ▼ navigation buttons.
- The OK button selects a field for editing and then confirms the entered value.

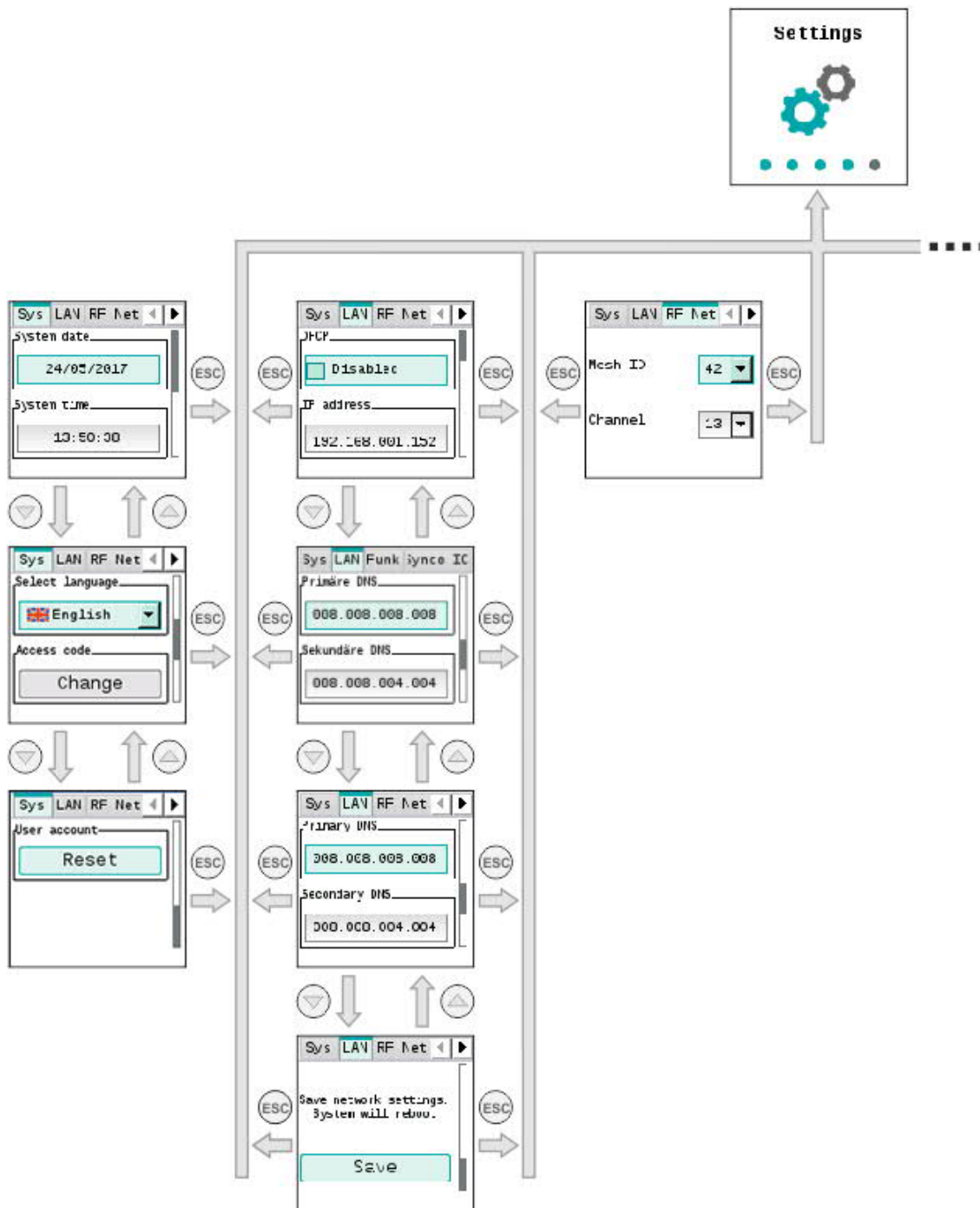

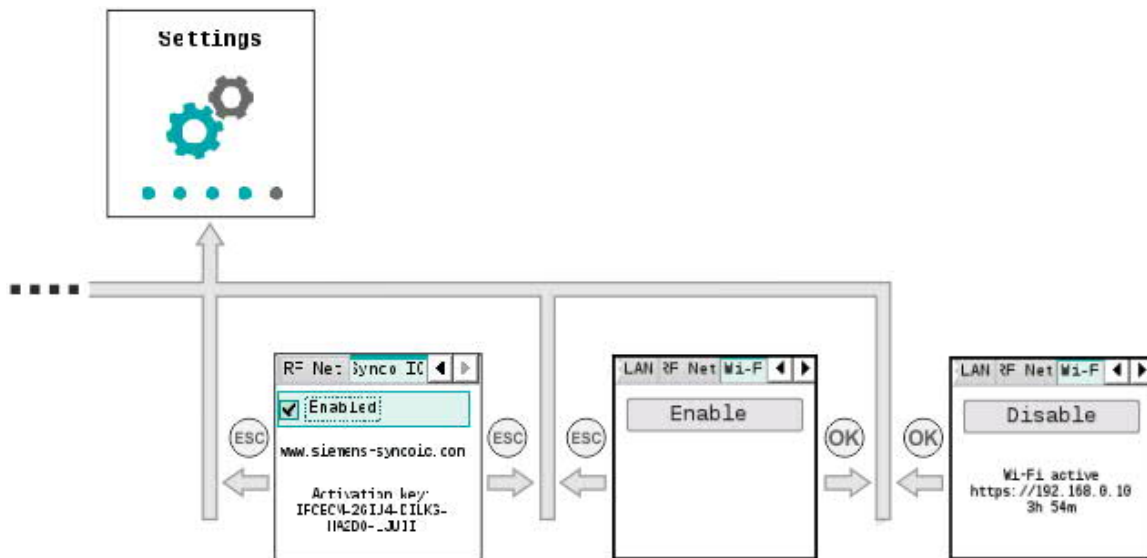

System The **System** sub-menu has the following settings:

System date Enter the current date of the web server.

System time Enter the current time of the web server.

Select language Select the language on the web server display.

Important  The language set locally on the web server is also used for sending emails and to generate reports and alarm notifications. As a result, it is important to select the correct language during web server commissioning.

Change access code You can change the local access code on the web server at any time for security reasons.
Additional information is available in section 'Operating', pg. 49.

Reset user account You can reset the user account on the local display if you have forgotten the login data for web server access. You must re-register after resetting the user account.
For details, see section 'Operating, Reset user account, pg 49.

LAN The **LAN** sub-menu has the following settings:

DHCP Enable or disable the DHCP client on the web server.
The web server draws its IP address automatically from the DHCP server (router) if the DHCP client is enabled.
The following parameters must be entered manually if the DHCP client is disabled:

IP address Web server IP address. Is not set for "DHCP = Enabled" (default value: 192.168.1.110)

Standard gateway The standard gateway represents the interface between the local and public network. You typically enter the IP address for the router here. Need not be set for "DHCP = Enabled" (default value: 192.168.1.1)

Network mask The IP subnet mask sets the size of the network. Need not be set for "DHCP = Enabled" (default value: 255.255.255.0)

Primary DNS	<p>The DNS name server (domain name system) on the Internet connects a globally valid name to a domain with an IP address (e.g. domain www.siemens.com with IP address 146.254.191.150).</p> <p>The setting corresponds to the IP address for the next router or DNS name server that recognizes for its part a queried name (domain) or another DNS name server. The setting is typically identical to the setting for the standard Gateway. Need not be set for "DHCP = Enabled"</p> <p>If the DHCP settings are deactivated, please contact your local administrator for the specification of the parameters (default value: DNS1:8.8.8.8).</p>
Secondary DNS	<p>A secondary DNS name server is only defined for redundant systems. Settings are typically empty. Need not be set for "DHCP = Enabled" (default value: DNS2: 8.8.4.4)</p>
Save network settings Restart	<p>The current network settings are saved and web server restarts.</p>
RF network	<p>You can set the following In the RF network submenu:</p>
Mesh ID	<p>Enter the mesh ID. Ensure that all RF converters are on the same mesh network.</p>
Channel	<p>Mesh network channel: You can change the channel ID here in the event of faults.</p>
Synco IC	<p>The following settings are available in the Synco IC submenu:</p>
Synco IC reports	<p>Enable or disable the automation transmission of Synco IC reports to the cloud.</p>
Synco IC portal	<p>The Synco IC portal is available at: https://www.siemens-syncoic.com.</p>
Activation key	<p>Displays the activation key. The activation key is required to register the web server in the Synco IC portal.</p> <p>Detailed information on integrating the web server via the Synco IC portal is available in Section 'Web server integration in Synco IC', pg. 44.</p>
WLAN connection	<p>To enable the WLAN connection, press the ESC key on the web server for at least 5 seconds.</p> <p>Additional information on the web server keys is available in section 'Web server', page 15.</p>



The IP address and remaining time for the active WLAN connection is displayed after enabling the WLAN connection.



Note

The WLAN connection remains active for up to 12 hours after enabling.

Press the OK button and enter the web server access code to display additional information on the WLAN connection or to disable the WLAN connection on the web server on the display.

Additional information on the web server access code is available in section 'Access code entry', page 49.

WLAN status
WLAN address

You can display the remaining time for the WLAN connection and the WLAN address in the Info menu as long as the connection is active. Press the down arrow key to go to the desired information.

Additional information on 'System info' menu is available in section 'System info menu', page 52.

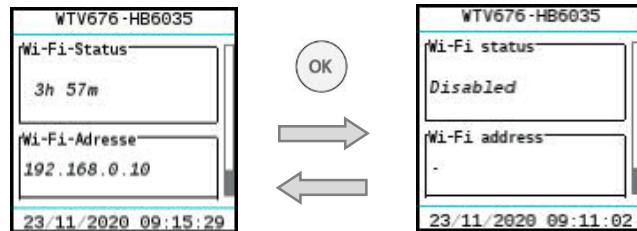

Enable/disable
WLAN connection

You can enable or disable the WLAN connection in the 'Settings' menu. Press the right arrow to go to the desired display. Press the OK button to enable or disable the WLAN connection.

Additional information in the 'Settings' menu is available in section 'Settings menu', page 57.

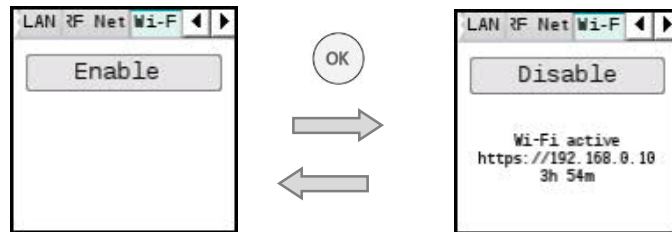

12 Web server browser operation

12.1 Registration & login

Prerequisite

The web server and the PC are connected to the same network and the network access is configured. See section "Connect web server to PC or LAN", page 39.

Initial registration

To access web server, enter the web server IP address (e.g. https://192.168.1.110) in the browser (Chrome, Safari, Firefox).

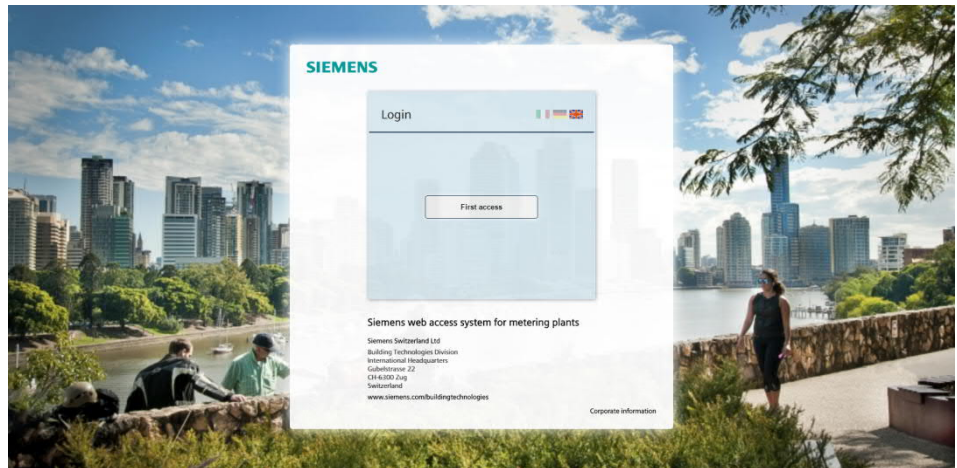

Complete the mandatory fields:

- Email
- Username
- Password
- Confirm password

to register and receive access to the web server.

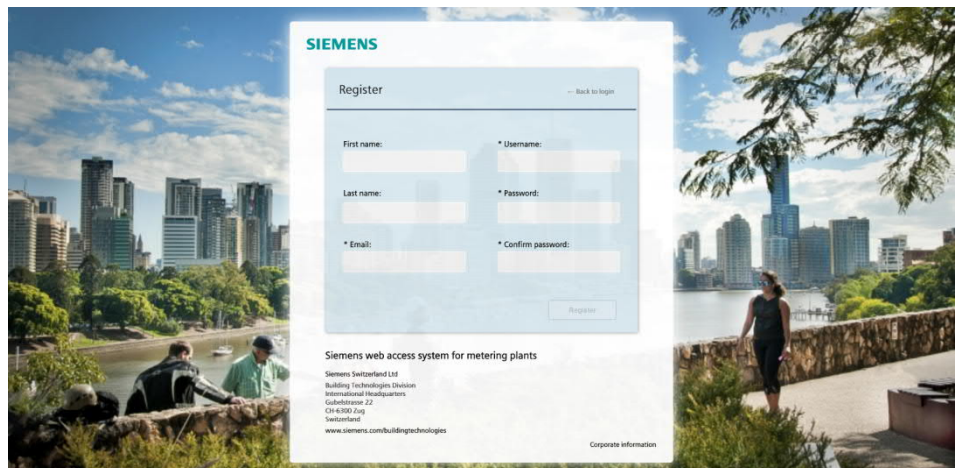

The password must meet the following conditions:

- At least 8 characters
- Three of the following 4 criteria must be fulfilled:
 - Lowercase letters
 - Uppercase letters
 - A digit
 - A special character

Important



The **Register** button is only enabled after meeting the password conditions.

Sign in

You are notified if you enter an incorrect login or password. The login is locked on the web server for five minutes (300 s) after a maximum of six attempts.



Contact the administrator if the user or maintainer forgets the access data. The administrator can delete the current account and set up a new one.

Very important!



Loss of administrator password:

You can reset the user account on the local display if you forgot the administrator password for web server access.

Additional information on resetting the user account is available in section 'Operating', section 'Reset user account', pg. 50.

Sign in

Web server goes to the Login page after successful registration. You can now log in using the new username and password.

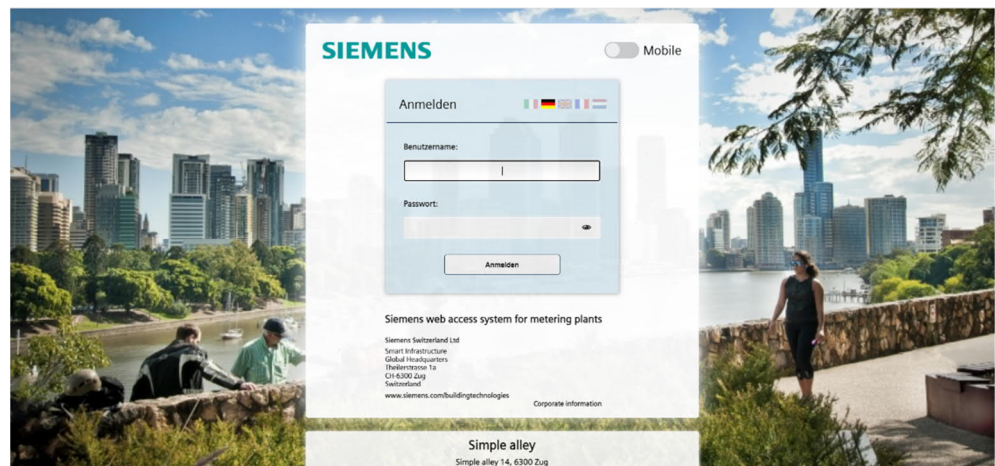

Confirm with **Sign in** to go to the web server main page.

'Mobile' option

The 'Mobile' option reads the web server on site using your mobile phone or tablet over WLAN.

Make sure the WLAN connection is active on the web server.

Additional information on enabling WLAN and displaying the IP address is available in section 'WLAN connection, page 59.

To connect the mobile device to the web server, open the browser on your mobile device and enter the IP address of the web server (e.g. <https://192.168.0.10>). The login page of the web server displays as soon as your mobile device is connected to web server.

Enable the 'Mobile' option to optimize the display on your mobile device.

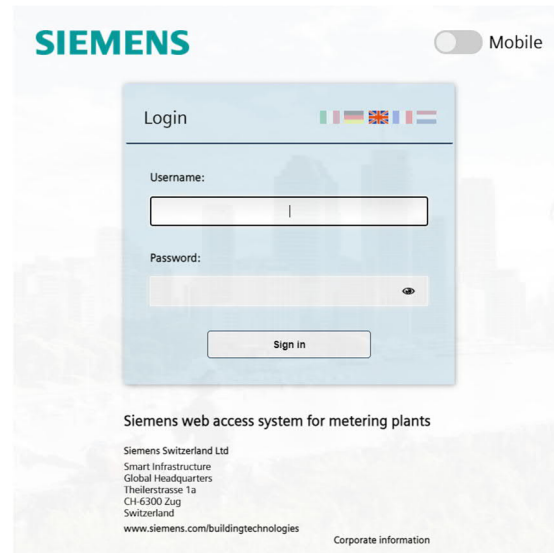

Note

If you use the standard login page, the display of the login page is automatically optimized.

Login with your username and password to go to the overview (optimized to your mobile device).

Additional information on reading out data via WLAN is available in section 'Readout mobile data', page 115.

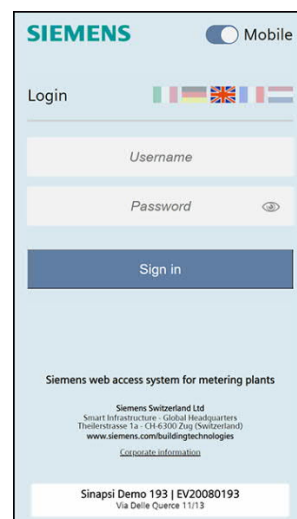

12.2 Home

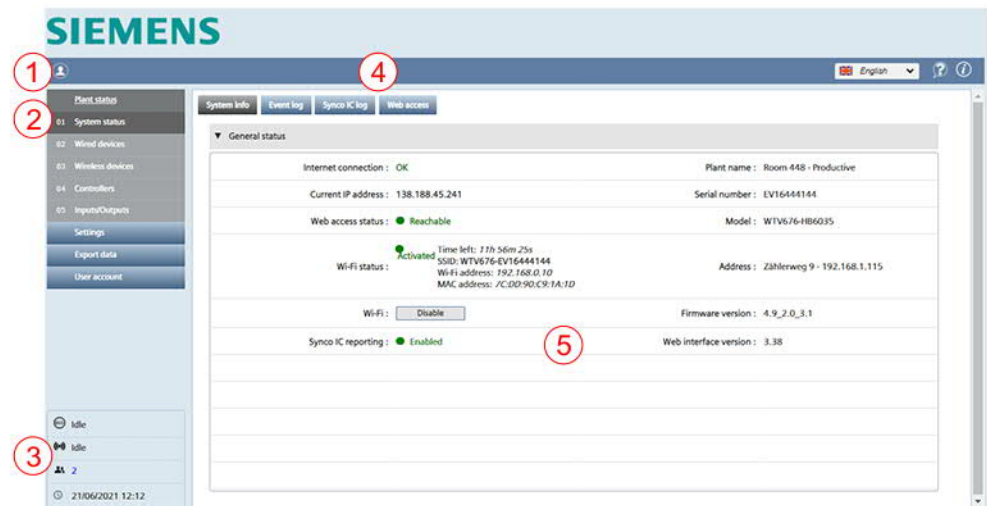

- ① The following information is displayed on the title line:
 - Name of the logged in user.
 - Language selection.
 -  Information on "Open source software" packets and licenses.
- ② Primary navigation using the main menu:
 - Plant status (as of page 65)
 - Settings (as of page 79)
 - Export data (as of page 107)
 - User account (as of page 121)
- ③ Status Information:
 - M-bus status
 - Status M-bus radio
 - Number of logged on users
 - Date and time.
- ④ Secondary navigation using sub-menus
- ⑤ Information on menu and sub-menu page

12.2.1 Select the web server language (software interface)

You can set the operating language for the software interface in the title line to the right.

The following languages are available:

- English
- German
- Italian
- French
- Dutch

Important

The login always used the default language that was selected and is displayed on the display. The language setting in the login window applies exclusively to the current session. The language setting on the web server software interface apply exclusively for the current session after login.

All automatic reports use the default language. See section Select default operating language, page 48. All manual reports created on the web server use the language for the current session.

12.3 Plant status

The Plant status main menu displays all important information on the web server, connected devices, and events occurring on the bus.

12.3.1 System status

System status

System status displays system information, WLAN status, the event log and logging on the Synco IC cloud.

System information

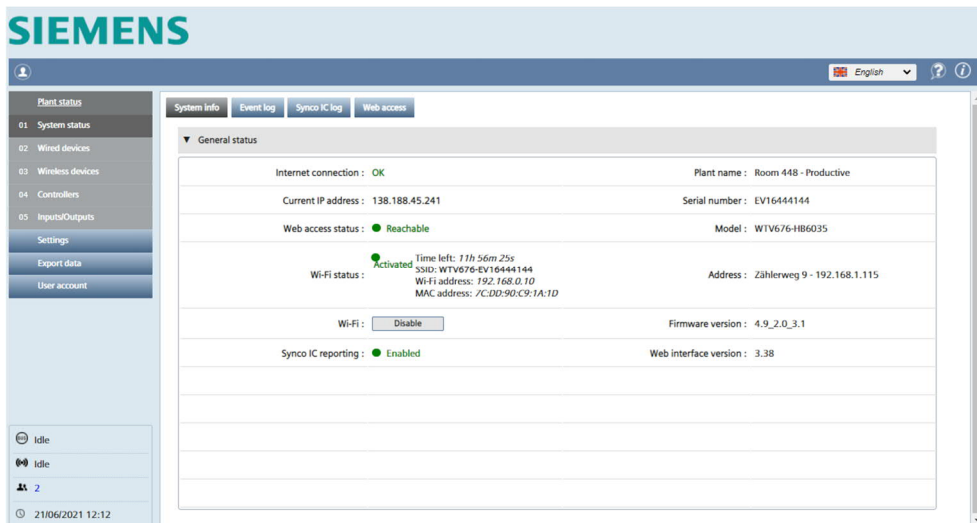

The screenshot shows the Siemens web server interface. The top navigation bar includes 'System info', 'Event log', 'Synco IC log', and 'Web access'. The main content area is titled 'General status' and contains the following information:

Internet connection : OK	Plant name : Room 448 - Productive
Current IP address : 138.188.45.241	Serial number : EV16444144
Web access status : ● Reachable	Model : W1V676-HB6035
Wi-Fi status : ● Activated Time left: 11h 56m 25s SSID: WTV676-EV16444144 Wi-Fi address: 192.168.0.10 MAC address: 7C:DD:90:C9:1A:1D	Address : Zählerweg 9 - 192.168.1.115
Wi-Fi : <input type="button" value="Disable"/>	Firmware version : 4.9_2.0_3.1
Synco IC reporting : ● Enabled	Web interface version : 3.38

The following information is available under System status:

- Internet connection: Displays the current state of the web server Internet connection.
- Current IP address: Displays web server's last public IP address.
- Status web access: Indicates whether the web access service is active, see 'Web access'.
- WLAN status: Displays the current state of the WLAN connection.

- WLAN: You can enable or disable the WLAN connection using the 'Enable' or 'Disable' button.
- Synco IC reporting: Display the current status of automatic transmission of Synco IC reports to the cloud. See Section "Setup automatic reports, as pg. 109.
- Plant name: Name of the plant.
- Web server serial number
- Model: Displays the web server type designation.
- Address: Plant location.
- System clock: Current web server date and time.
- Firmware version: Displays the firmware version installed on the web server.
- Web interface version: Displays the installed version of the web user interface.

WLAN status

Click 'Enable' to enable the WLAN connection.

You can also enable the WLAN connection directly on web server. See section 'WLAN connection', page 59.

The screenshot shows the Siemens web server interface. The user is logged in as Claudio Bozzi. The main menu on the left includes Plant status, System status, Wired devices, Wireless devices, Controllers, Inputs/Outputs, Settings, Export data, and User account. The 'General status' section is expanded, showing the following information:

Internet connection : OK	Plant name : Room 476 - Staging
Current IP address : 138.188.45.241	Serial number : EV16444187
Web access status : ...	Model : WTV676-HB6035
Wi-Fi status : ● Not active	Address : Zählerweg 9 - 192.168.1.108
Wi-Fi : <input type="button" value="Enable"/>	Firmware version : 4.9_2.0_3.1
Synco IC reporting : ● Enabled	Web interface version : 3.38

At the bottom left, there are three status indicators: a power icon labeled 'Idle', a signal icon labeled 'Idle', and a user icon labeled '1'. The bottom right corner shows the date and time: 21/06/2021 12:19.

Event log

ID	Type	Start date	End date	Category	Reference	Description	Select
	FTP	2017-06-27 14:34:25	-	FTP	FTP ID 9(1)	FTP - Automatic reports	<input type="checkbox"/>
	✓	2017-06-27 14:27:06	2017-06-27 14:27:06	Email	Email ID 62	Email - Automatic reports	<input type="checkbox"/>
	FTP	2017-06-27 14:27:03	-	FTP	FTP ID 8(1)	FTP - Automatic reports	<input type="checkbox"/>
	FTP	2017-06-27 14:20:20	-	FTP	FTP ID 8(1)	FTP - Automatic reports	<input type="checkbox"/>
	✓	2017-06-27 14:10:36	2017-06-27 14:10:36	Email	Email ID 61	Email - Automatic reports	<input type="checkbox"/>
	FTP	2017-06-27 14:10:33	-	FTP	FTP ID 7(1)	FTP - Automatic reports	<input type="checkbox"/>
	FTP	2017-06-27 14:07:45	-	FTP	FTP ID 7(1)	FTP - Automatic reports	<input type="checkbox"/>
	FTP	2017-06-27 13:56:40	-	FTP	FTP ID 6(1)	FTP - Automatic reports	<input type="checkbox"/>
	✓	2017-06-27 02:12:04	2017-06-27 02:12:04	Email	Email ID 60	Email - Alarm notification	<input type="checkbox"/>

The event log records the following events:

- Alarms and warnings
- Change of state of inputs/outputs
- Send status of emails
- Send status of information via FTP

The following information can be read by event:

- Event status
- Start date/time
- End date/time
- Category
- Reference
- Description

The following event status can be displayed:

- ✓ Device OK: Reported alarms or warnings are corrected.
- ⚠ Device fault: A device fault reported via M-bus.
- ⚠ Communications error: Communication with M-bus device not possible.
- ✓ Email successfully sent.
- ✉ The email could not be sent (over 3 days at 15 minute intervals, not successful).
- FTP The readout file was successfully transmitted to a FTP server.
- FTP The readout file was unable to be transmitted to a FTP server (over 3 days at 15 minute intervals, unsuccessful).
- IN Change of state registered at an input.
- OUT Change of state registered at an output.

Simply set filters for each column to limit search results by specific events.

The event log registers up to 1000 events. The oldest event is removed after 1000 events.

Individual lines on the event log or the entire list can be deleted. Proceed as follows:

- Delete individual rows: Select the event check box to be deleted and then click **Delete event** in the upper end of the list. The **Delete event** is enabled if at least one line is selected.
- Delete complete list: Select the check box on the title line and then **Delete event** to irretrievably delete the entire event log.

Note



Display only active events to list only currently pending alarms and input/output status.

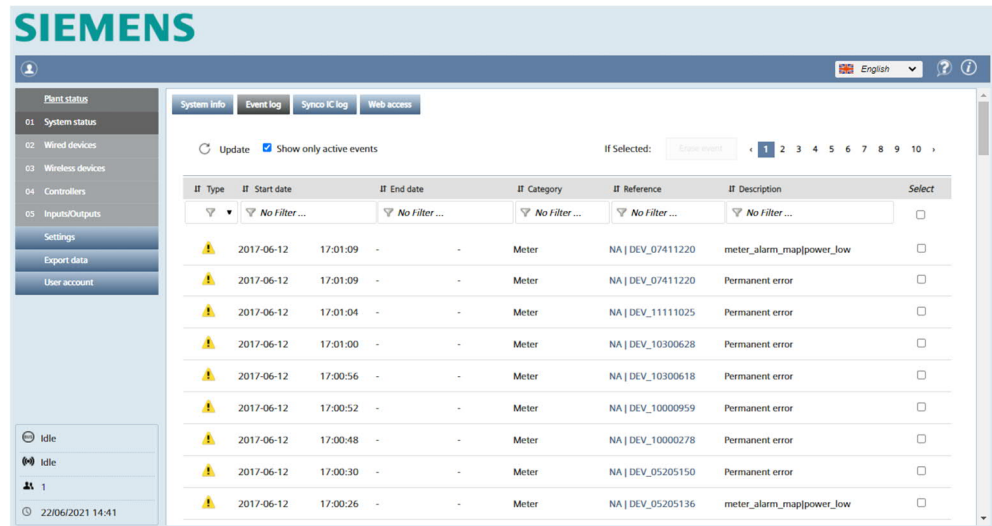

Click a line to display event details, e.g. the sent email including appendix and the last readout data just prior to the fault.

Connection Synco IC

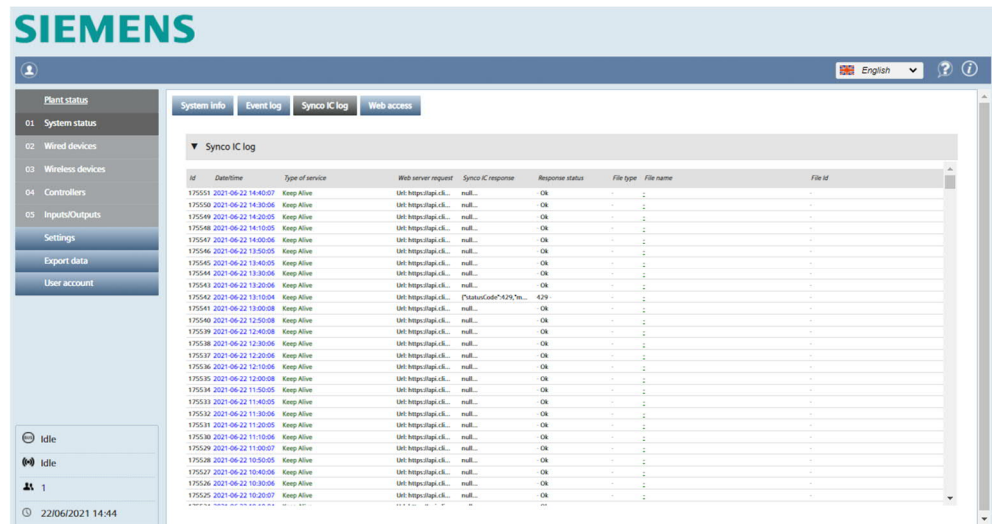

The web server has a log for the Synco IC cloud. The log records transactions between the web server and the cloud. For example, a timestamp displays when and which files (e.g. billing files) were uploaded to the cloud.

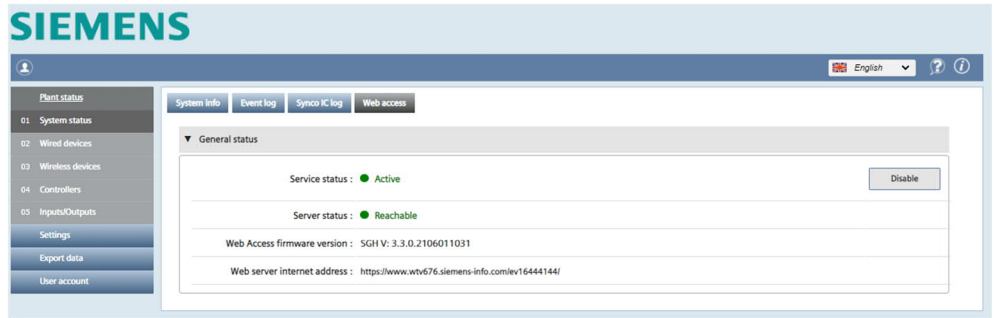

The web access connects to the web server from anywhere. The web access is enabled by default and can be disabled with the 'Disable' button.

Note

 If deactivated, the web access can only be activated locally.

The web server link opens the web server login page. You must login with user name and password to proceed to the web server home page.

12.3.2 Wired devices

Wired devices

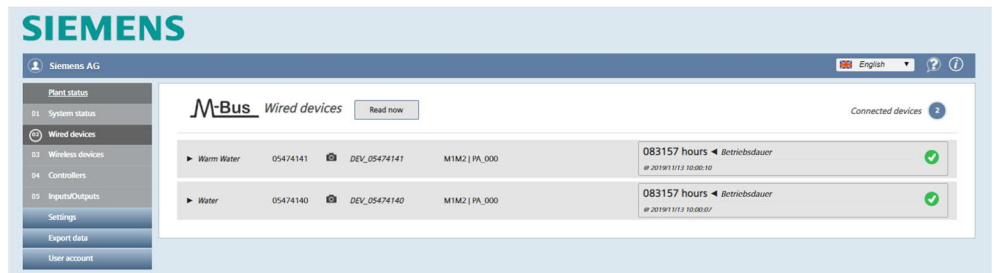

The **Wire devices** overview lists all M-bus devices located on the network in an abbreviated form.



The following information can be read out per line (per M-bus device):

- Medium (colored field)
- Serial number (secondary address)
- Availability of device image
- Device Name
- Description
- Main value (=> Can be selected, see Section "Wired devices", as of page 69)
- Last readout timestamp
- Device state

The following device status can be displayed:

-  Device ok
-  Device fault
-  Communication error

Click a line to list additional device information.

The screenshot shows the Siemens M-Bus Wired devices interface. The left sidebar contains navigation options: Plant status, System status, Wired devices (selected), Wireless devices, Controllers, Inputs/Outputs, Settings, Export data, and User account. The main area displays details for a device with ID DEV_05474141. Key information includes:

- Device name: DEV_05474141
- Description 1: PA_000
- ID Device: 05474141-32650604
- Medium: Warm Water
- Communication status: OK
- Last readout timestamp: 2019/11/13 10:00:10
- Scan interval: 1 month
- Install date: 7.3.09/2019
- Primary address: 0
- Manufacturer code: LSE

 A table below shows the last readout timestamp data for various parameters over a period of six days (from 2019/11/08 to 2019/11/13). Parameters include Aktuelles Volumen (Volume), Betriebsdauer (On Time), Aktuelles Datum und Uhrzeit (Time Point), Fehlerdatum (Time Point), and Seriennummer (Fabrication Number). A 'Betriebsdauer' section shows a total of 083157 hours. A device image of a Siemens AEW310.2 is also visible on the right.

The information that cannot be changed are grouped into three categories:

- Device information: General device data (name, description, ID, medium, etc.)
- Last readout timestamp: Displays the values of the last 6 readouts.
- Alarm status: Displays the faults pending on the device and which ones are registered and sent via email.

The data points for display in detail, can be predefined in the menu **Settings / Wired devices / Device settings** (see page 89 et seq.).

Click **Read now** to manually trigger a complete readout of the data from all devices.

12.3.3 Wireless devices

Wireless devices

The **Wireless devices** overview lists all the M-bus wireless devices on the network in a compact form.

The screenshot shows the Siemens M-Bus Wireless devices overview interface. The left sidebar is identical to the previous screenshot. The main area displays a list of wireless devices with their current status and data points. The list includes:

- Water: 00000000, DEV_00000000, 0 m3 Total volume
- Warm Water: 00000001, DEV_00000001, 0 m3 Total volume
- Water: 57794605, DEV_57794605, 25.637 m3 Total volume
- Water: 57794606, DEV_57794606, 32.215 m3 Total volume
- Heat: 68063678, DEV_68063678, 5707 kWh Total energy consumption
- HCA: 71253709, DEV_71253709, 000000 Total HCA
- HCA: 92160076, DEV_92160076, 000161 Total HCA

 Each device entry shows a 'Wait data' button and a 'Total' value with a timestamp. The Heat and HCA entries also show additional data points like pressure and temperature.

The following information can be read per line (i.e. per M-bus wireless devices):

- Medium
- Serial number
- Availability of device with optional image
- Device name
- Description
- Main value (=> selectable, see Section “Wireless devices, as page 100)
- Date/time of last device reading
- Device status

The following device status can be displayed:

- ✓ Device is OK
- ⚠ Device fault
- ⚠ Communication error

Click a line to list additional information on a particular device.

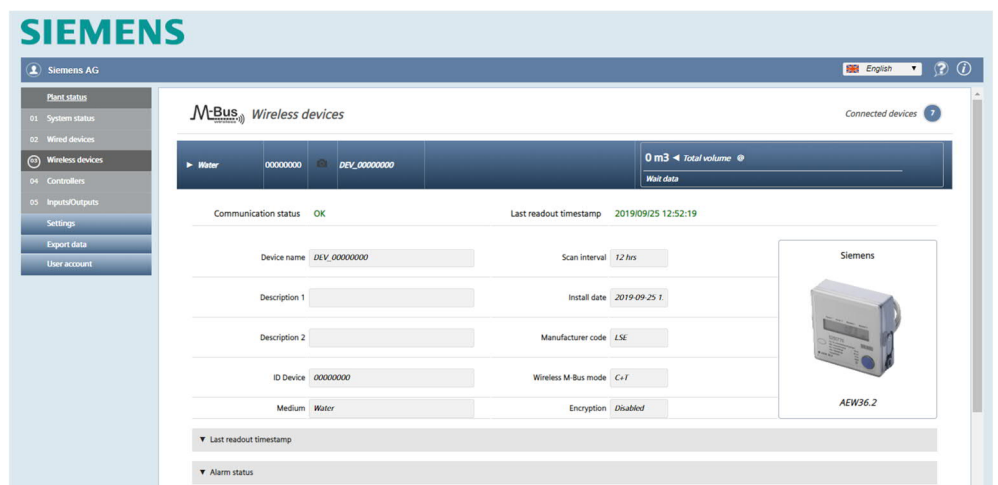

This information cannot be changed and is summarized in three categories:

- Device information: General device information (Name, description, ID, medium, query interval, installation date, manufacturer code, RF mode, encryption, etc.)
- Last read out timestamp: Displays the values of the last 6 read outs.
- Alarm state: Indicates errors pending on the device and which ones are registered and sent by email.

Note

 Query intervals are required to generate reports. A query interval can be individually defined for each device. The “Scan interval” determines the intervals at which the device read outs are saved. Additional information on query intervals is available in Section 'Creating reports', pg. 116.

You can predefine the data points you want to detail in the menu 'Settings' > 'Wireless devices' > 'Device settings' (see page 100).

12.3.4 Controller

Controller

The controller overview lists all RVD controllers (compact) connected to the network.



The following information can be read out per line (per RVD controller):

- Available device image
- Device type
- Serial number
- Device name
- M-bus line
- Device description
- Available plant type
- Plant type
- Main value (temperature)
- Date/time of last device read out
- Device state

The following device status state can be displayed:

- ✓ Device is OK
- ⚠ Device fault
- 🚫 Communication error

Click a line to list additional information on the device.

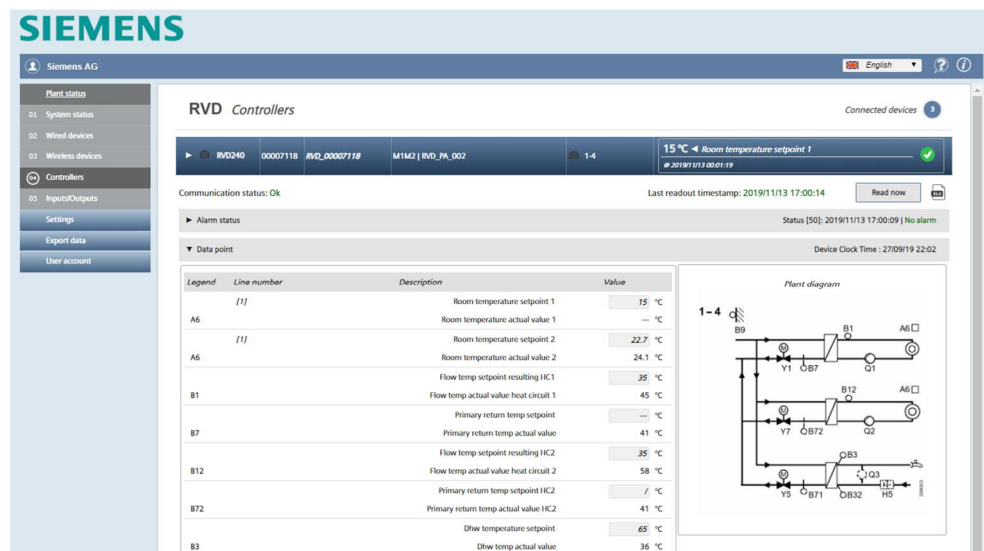

This information cannot be edited and compiled into the following categories:

- Communication state: Indicates whether the device can be reached on the network
- Time stamp for last readout: Displays the data and time of the last readout
- Alarm state: Lists the current alarm messages with date and time
- Data point: Displays the plant-specific diagram and the associated data points.

Additional information is available in section 'Data point settings'. Data point settings Additional information on plant types is available in document G2383. See section 'Reference documents', pg. 7.

Notes



Displays the last read data from a controller. The date and time of the last readout are visible in the timestamp for the last readout. Controllers RVD230, RVD235, RVD240, RVD245, RVD250, RVD255, RVD260 and RVD265 can be read out.

Read out controller data now

Click the button 'Readout now', to immediately read out all data points and alarms for the corresponding controller independent of the readout interval.

List all data points



Click the  symbol to list all data points for the associated controller and plant type. The most recent values are read out.

Serial number	Device name	Description	Device type	Plant type	M-Bus line
00050240	RVD_00050240	RVD_PA_000	RVD230	1-0	M1M2
Setpoint					
Number	Line number	Data point	Value	Units	Last readout timestamp
1	[164]	Outside temp composite	0	°C	07 Nov 2019 00:00:42
2	[1]	Room temperature setpoint 1	20	°C	07 Nov 2019 00:00:42
5		Flow temp setpoint resulting HC1	50	°C	07 Nov 2019 00:00:42
7		Return temp max limitation secondary	---	°C	07 Nov 2019 00:00:42
18		Actual setpoint temp differential HC1	---	°C	07 Nov 2019 00:00:42
Plant I/O					
Number	Line number	Data point	Value	Units	Last readout timestamp
1	[25]	Outside temp	---	°C	07 Nov 2019 00:00:46
3		Primary return temp actual value	---	°C	07 Nov 2019 00:00:46
4		Flow temp actual value heat circuit 1	---	°C	07 Nov 2019 00:00:46
5		Return temp actual value HC1	---	°C	07 Nov 2019 00:00:46
6		Room temperature actual value 1	---	°C	07 Nov 2019 00:00:46
16		Analog input U1	---	V	07 Nov 2019 00:00:46
19		SecPressSens	/	bar	07 Nov 2019 00:00:46
20		Primary pressure sensor	/	bar	07 Nov 2019 00:00:46
22		Stroke model HC1	/	%	07 Nov 2019 00:00:46
27		Heat circuit pump speed HC1	/	%	07 Nov 2019 00:00:46

Configuration In the 'Configuration' pane, various setting parameters for RVD controllers can be displayed, edited, backed up and restored. The data from the last readout of the controller is displayed (see last readout timestamp). Click 'Readout now' to start manual readout.

The 'Configuration' pane is divided into:

- Back and restore controller settings
- Plant-specific setting parameters (e.g. for heating circuits or DHW, etc.)
- Schedulers for operation (e.g. heating circuit or DHW, etc.)

Note  The 'Program switch' indicates whether the scheduler is active.

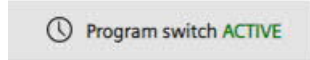

Backup and restore controller settings You can back up the current controller settings in this pane and eventually write them to the controller (restore). Values from other controllers can be taken over.

Note  The function 'Backup and restore' is only visible if you are logged on as administrator or Maintainer.







Create backup file You can back up the current controller settings in the menus 'Plant status' > 'Controller' > 'Configuration' and 'RVD configuration and settings'. To back up the current controller settings, click 'Create'.

The file name suggested by the system is composed by default of the following:

- Date and time
- Device type
- Device name
- Number of the plant diagram

To edit the suggested file name, click . The file name that you enter is automatically supplemented with the current date and time. To export the backup file and save it to desktop, click 'Export'.

Note  You can only create backup files from the last read controller settings. No backup is possible if certain controller settings are highlighted in blue or red. You must write the settings to the controller before you can create a backup file.

Note  To reset the entered file name, click .
This displays the suggested file name.
To delete a backup file from the web server, click .

Restore backup file You can select the backup file and upload it if you want to return to prior controller settings.
Access the backup file as follows:

- On the web server: Select the backup file from the list.
- On the desktop: Click 'Import' and select the backup file.

Note  The letters 'IMP' are added as a prefix to a backup file that is uploaded from the desktop (IMP = Imported).

Select the appropriate check box to determine the settings.
The following options are available:

- Check box 'RVD configuration': Overwrites the settings taken over in menu 'Plant status' > 'Controller' > 'Configuration'
- Check box 'RVD settings': Overwrites the settings taken over in menu 'Settings' > 'Wired devices' > 'Controller settings'

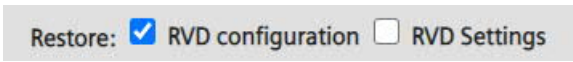

Note  Only the following parameters in menu 'Settings' > 'Wired devices' > 'Controller settings' are overwritten:

- User-defined parameters
- Main value
- Trend file – Received data points

To overwrite the controller settings, click 'Restore'. The corresponding settings are highlighted in blue and can be edited as needed.
To take over all settings, click 'Write'.

Note  You can write controller settings saved to a backup file to another RVD controller. The controller settings saved in the backup file, the other RVD controller must, however, have the same device type, device name, and corresponding plant diagram as the original.
An error message displays if a value does not match, no settings are overwritten in this case.

Plant-specific setting parameters The following data points can be written via M-bus, depending on

- connected RVD controller type
- the corresponding plant diagram

Designation	RVD23x	RVD24x	RVD25x	RVD26x
DHW temperature nominal setpoint	X	X	X	X
DHA temperature reduced setpoint	X	X	X	X
Temperature difference Solar On	X	X	X	X
Temperature difference Solar Off	X	X	X	X
Date of first day of heating period	X	X	X	X
Date of last day of heating period	X	X	X	X
Heating limit ECO heating circuit 1	X	X	X	X
Room temperature reduced setpoint heating circuit 1	X	X	X	X
Heating curve parallel shift heating circuit 1	X	X	X	X
Heating limit ECO heating circuit 2	-	X	-	X
Room temperature reduced setpoint heating circuit 2	-	X	-	X
Room temp. Setpoint holiday mode/frost protection Heating circuit 2	-	X	-	X
Heating curve parallel shift heating circuit 2	-	X	-	X

Legionella function frequency	X	X	X	X
Time	X	X	X	X
Scheduler heating circuit 1 Monday	X	X	X	X
Scheduler heating circuit 1 Tuesday	X	X	X	X
Scheduler heating circuit 1 Wednesday	X	X	X	X
Scheduler heating circuit 1 Thursday	X	X	X	X
Scheduler heating circuit 1 Friday	X	X	X	X
Scheduler heating circuit 1 Saturday	X	X	X	X
Scheduler heating circuit 1 Sunday	X	X	X	X
Scheduler HC2 Monday	-	X	-	X
Scheduler HC2 Tuesday	-	X	-	X
Scheduler HC2 Wednesday	-	X	-	X
Scheduler HC2 Thursday	-	X	-	X
Scheduler HC2 Friday	-	X	-	X
Scheduler HC2 Saturday	-	X	-	X
Scheduler HC2 Sunday	-	X	-	X
Scheduler HW Monday	X	X	X	X
Scheduler HW Tuesday	X	X	X	X
Scheduler HW Wednesday	X	X	X	X
Scheduler HW Thursday	X	X	X	X
Scheduler HW Friday	X	X	X	X
Scheduler HW Saturday	X	X	X	X
Scheduler HW Sunday	X	X	X	X

The parameters can be edited with a slider or manually. All edited parameters are highlighted in blue. Click 'Write' to write the edited parameters (highlighted in blue) to the controller.

Create a backup file after setting the parameters to restore the setting parameters at any time.

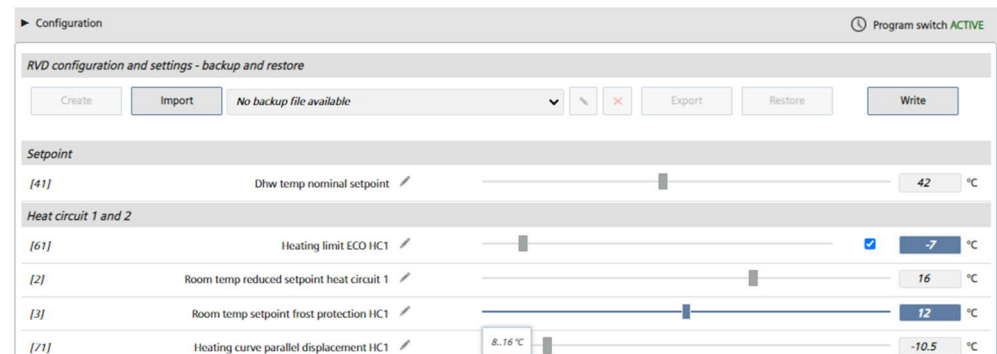

Additional information on creating a backup file is available in section 'Create backup file', page 73.



Note  Parameters outside the value range are highlighted in red. No data is written to the controller in the event of erroneous values.

Scheduler The scheduler defines when a part of the plant, e.g. a heating circuit or DHW plant, is operated.

For example, you can program a time switch for individual days of the week (Monday through Sunday) in the pane 'Scheduler for heating circuit 1'. Enter the start time and end time of operation. Multiple entries per day are possible. You can individually program the time switch for each day. Click 'Write' to save the entered parameters and write them to the controller.

Note  To apply the scheduler for Monday to other days of the week, click  and select the option 'Monday to Sunday' or 'Monday to Friday'.
For example, to copy the scheduler settings for heating circuit 1 to heating circuit 2, click  in the pane for 'Scheduler for heating circuit 1'. Select 'Apply this scheduler to:' and click 'Copy'.
Click 'Write' to copy the settings to the scheduler and write them to the controller.

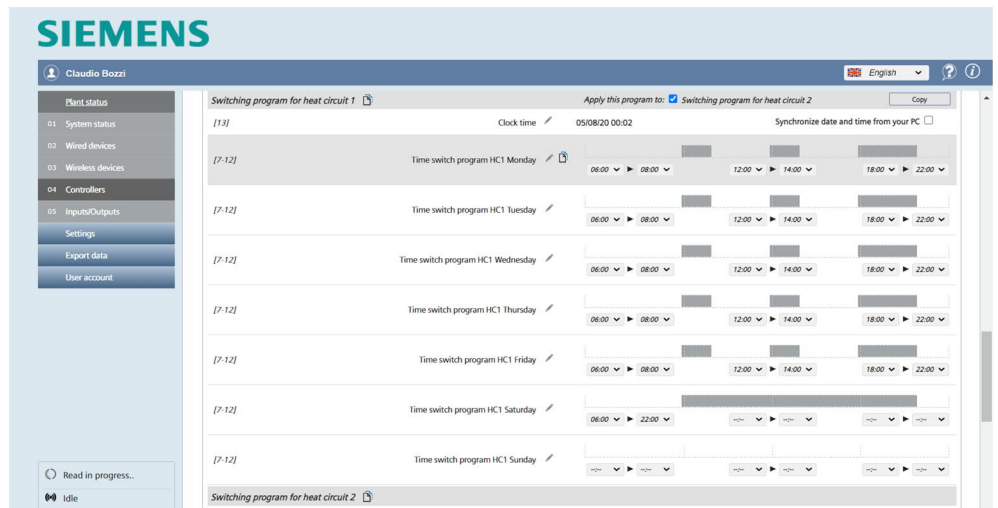

Create a backup of the parameters to restore the setting parameters at any time.

12.3.5 Inputs/outputs

Inputs/outputs

Displays the current status (open/closed) of inputs/outputs on web server. .

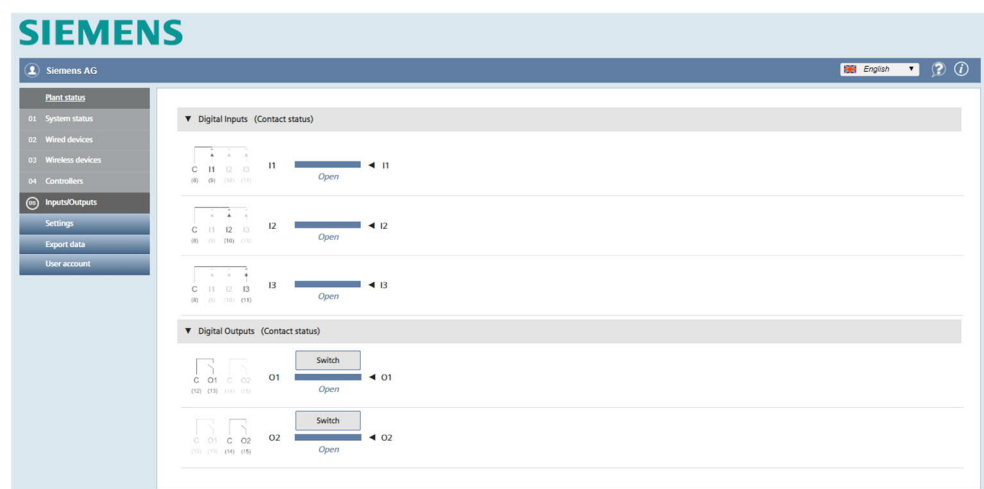

The following information can be read by input/output:

- Image of connection terminals on web server
- Short description: I = Input, O = Output
- Status: Open/closed
- Designation

Click **Switch** to manually switch the digital outputs.

Note

 This feature is only available for the user type “Administrator”

12.4 Settings

12.4.1 System

Plant data

The following plant data can be assigned to web server:

- Plant name
- Address
- Installer name
- Customer name
- Install date (the current date by default)

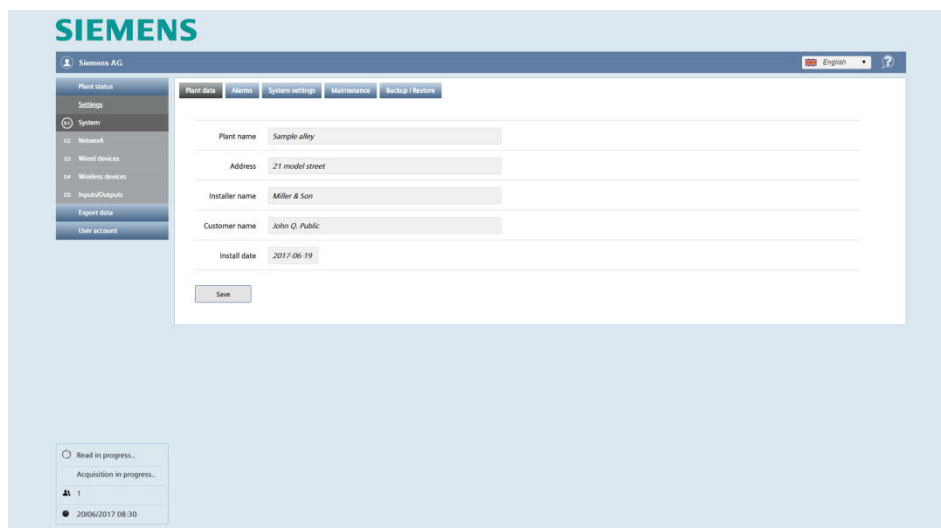

Note

 The edited data must be confirmed with **Save**.

The plant name and address are displayed on the home page in the lower section to easily ID the web server, even before logging in.

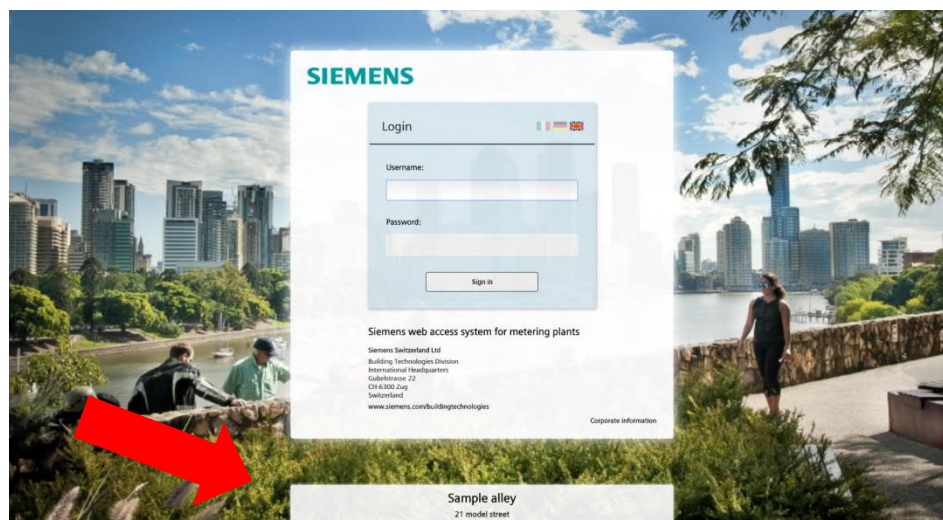

Alarms

As soon as web server detects an alarm, it sends an alarm notification to the designated email address(es):

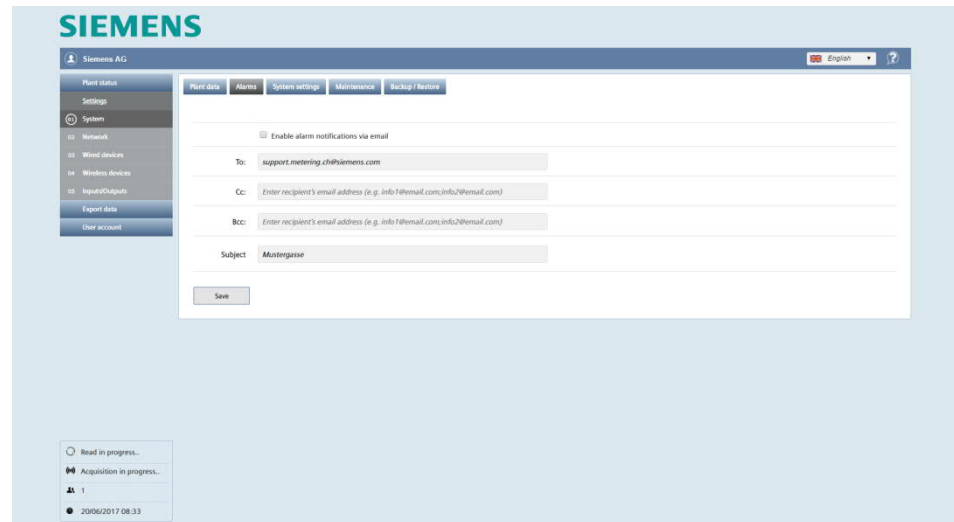

Emails are only sent if **Enable alarm notifications via email** is selected.

The alarm notification can be simultaneously sent to multiple recipients. Multiple email addresses must be separated by a semi-colon (;). The email subject line can be individually set to simplify classification in the event of multiple plants.

Synco IC can simultaneously transmit alarm messages from multiple M-bus web servers to multiple recipients. Alarm messages in the cloud can be sent either with or without attachments.

Note

The settings for the alarms in menu "Settings > System" have no influence on the Synco IC alarm notifications.

Note

You can define the email structure in the Synco IC portal and save it as a template. You can use templates for multiple plants and customize the configuration.

Additional information on setting up alarm notifications is available in the Synco IC user guide, document A6V10500249. See Section "Reference documents", pg. 7.

Confirm with **Save**.

System settings

System settings has four areas:

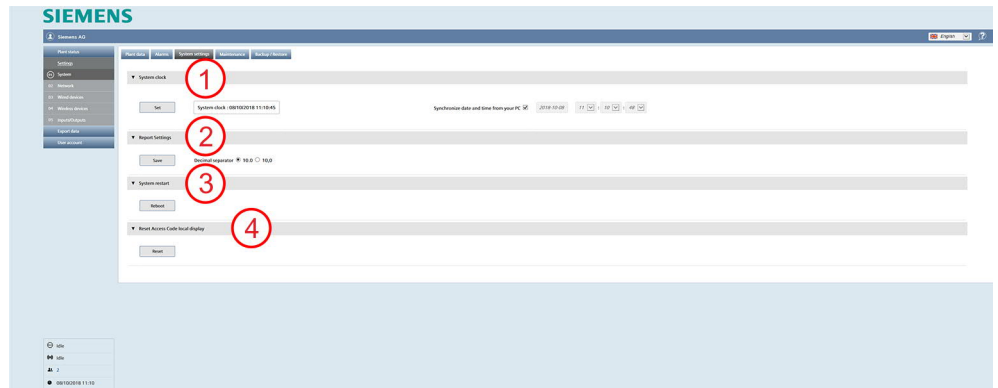

- ① **System clock:** You can automatically sync the system clock with the PC or enter it manually.
- ② **Report settings:** You can select whether to use a period or a comma as the decimal separator.
- ③ **System restart:** You can remotely restart the web server with System restart.
- ④ **Reset access code local display**
You can reset the access code for local access on web server. For security reasons, immediately change the password locally on the web server after a reset. See page 49

Important



The local access code cannot be entered remotely. You must visit the plant.

Maintenance

The page is used to update the web server firmware. Firmware can be updated online or offline. The firmware version can be installed directly from the Internet on the web server (online) or via PC (offline).

Update firmware online

Click 'Maintenance' to check whether a new version is available online.

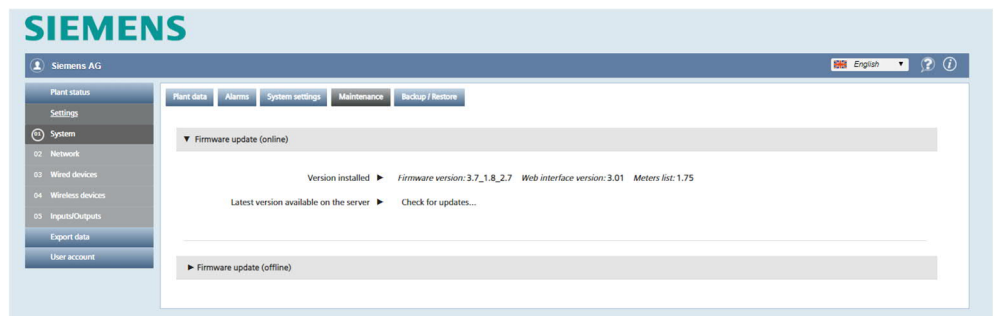

You are notified that your system is up-to-date if no newer firmware version is found.

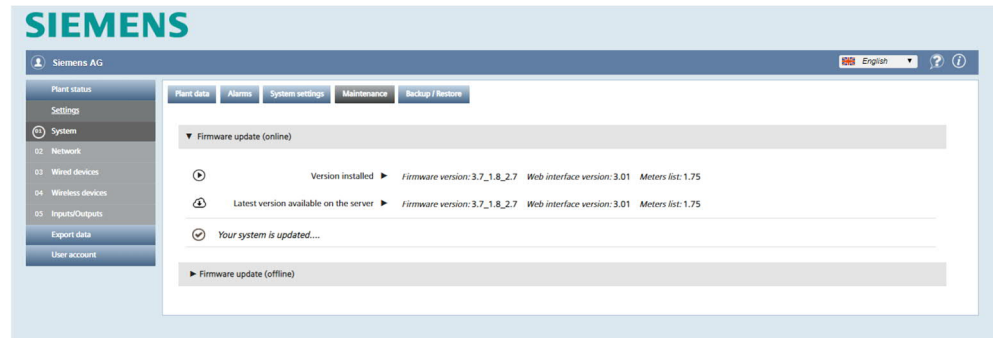

You are notified that an update is available for your system if a newer firmware version is found.

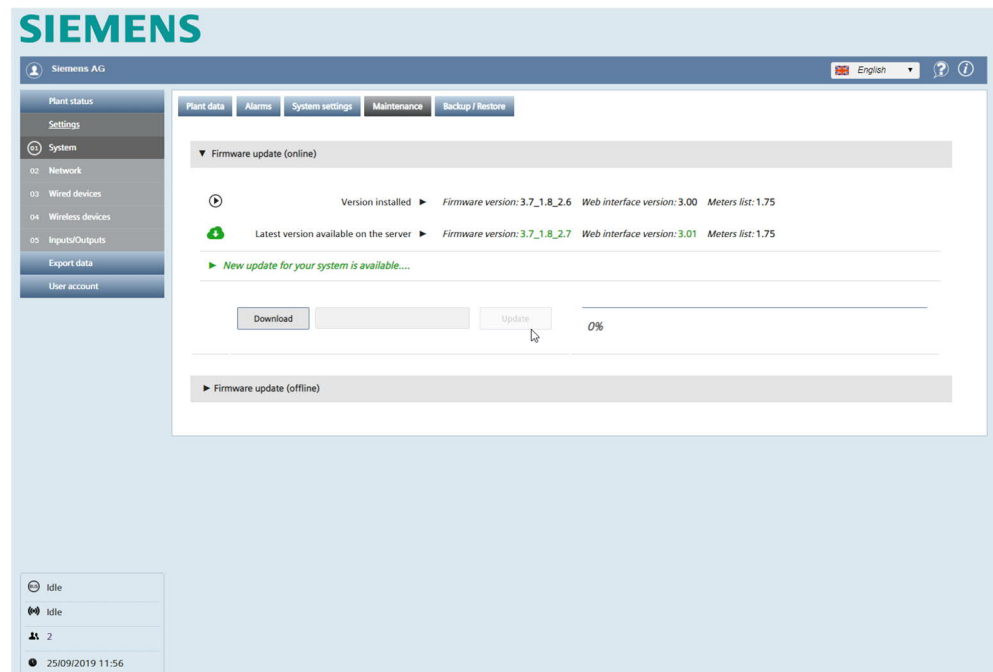

Load firmware

To load the available firmware on the web server, click 'Download'. As soon as the firmware is loaded to the web server, the button 'Update' is displayed.

Install firmware

To install the firmware on the web server, click the 'Update' button. The update may take a few minutes. The web server restarts after the update. The progress of the installation as well as the new start is displayed.

After restart, the log-in page for the web server displayed. Log on again on the web server. Additional information on log in is available in the section 'Sign in

Note

You can close and reopen the web browser if the update takes more than 15 minutes.

Check the update under 'Settings' > 'System' > 'Maintenance', to ensure the installed version on the server matches the available version. See section 'Update firmware online'.

Firmware as of version is available online as of SIE.WTV676_WI-2.47_FW-3.7-18-2.6.

Update firmware offline

You can also update the firmware offline if you do not have an Internet connection. Save the latest firmware on your PC.

To update the firmware offline, click button 'Select file' and select the firmware file 'xxx.bin' on your local folder.

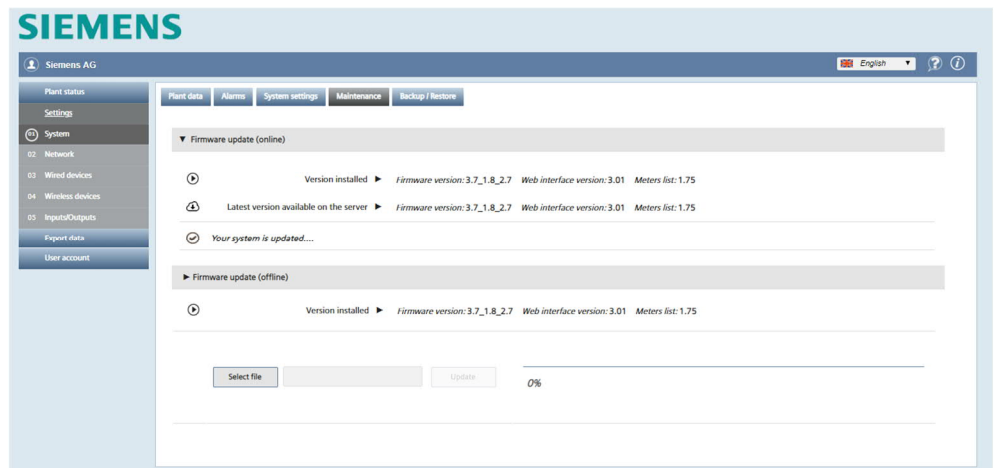

The button 'Update' displays after selecting the firmware file.

For additional information on firmware installation on the web server, see section 'Install firmware'.

Important



After a firmware update all data are available again. It is recommended to do a backup and to save the data on a PC before the actualization.

Backup/restore

All web server data is backed up and restored on this page.

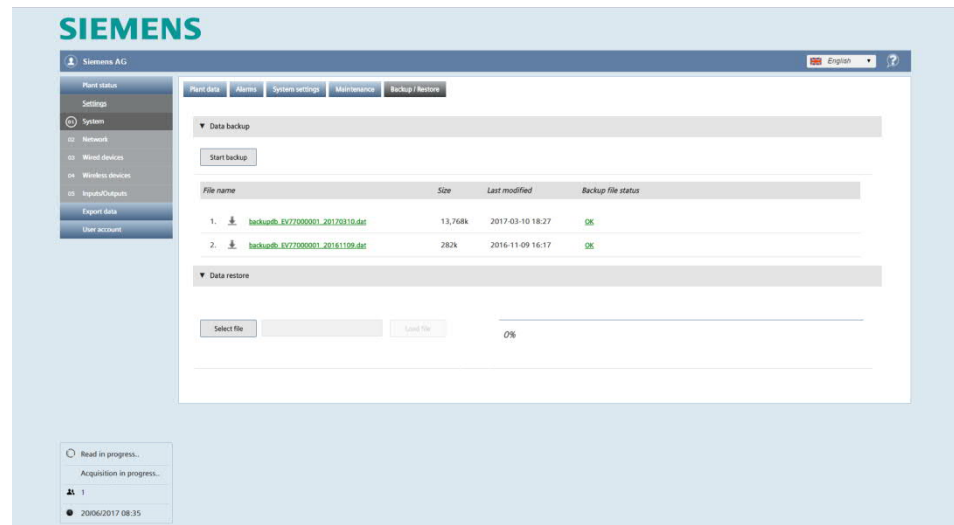

Important



We recommend regularly backing up web server data.

Data backup

The following information is displayed on each data backup:

- File name
- Size
- Last modified
- Backup file status

The backup file can be downloaded on a PC by clicking  or the file name and then uploaded to the same or another web server.

Important



Always copy backup files to your PC. This is the only way to load the backup file from a defective web server to a new web server.

Important



The backup file is encrypted. The device data cannot be altered.

Data restore

To transmit a backup file to web server, select the appropriate file (**Select file**) and install (**Load file**).

Web server restarts after updating.

Install progress as well as restart is displayed.

Important



This workflow irretrievably removes all data and settings on the current web server. As a result, we recommend conducting a backup of the current data prior to restoring.

12.4.2 Network

Network settings

The screenshot displays the Siemens AG network configuration interface. The main configuration area is titled 'Network ETH | Type: LAN'. The settings are as follows:

Field	Value
MAC address	FC02:3D:0D:F2:F4
External port for web server	12680
Enable DHCP	<input type="checkbox"/>
IP address	192.168.1.126
Netmask	255.255.255.0
Gateway IP address	192.168.1.1
Primary DNS	8.8.8.8
Secondary DNS	8.8.4.4

A 'Save' button is located at the bottom of the configuration area. The status bar at the bottom left indicates 'Read in progress...', 'Acquisition in progress...', and a timestamp of '2019/06/2017 08:36'.

The following information and settings are available (for additional details, see Section “M-bus commissioning on web server”, page 41):

- Web server MAC address.
- External port for web server: This setting is only used to add the external port to the external IP address which is part of the email header. The external port number must be the same as the external port number used in the port forwarding settings of the router, see page 123.
- Enable DHCP for the DHCP server (router) to automatically assign the IP address.
- Web server IP address if a fixed IP address is assigned.
- Network mask.
- Gateway IP address: IP address for the standard gateway (e.g. Router).
- Primary DNS: The primary DNS name server (Domain Name System) address
- Secondary DNS: Secondary DNS name server address

Click **Save** to confirm changes to the above parameters.

Important



Be careful when changing these settings! Ask your local network administrator for the required data on network configuration.

Web server is not suitable for connecting directly to the Internet; it must be connected via a Firewall. This type of router typically has a firewall.

WTV remote access

Web server WTV676.. and the router must be on the same network to use remote access.
Check the IP address of the web server and the gateway (router) in menu 'Settings' > 'Network' > 'Network settings'.

Network settings | Email setup | Dynamic DNS

▼ Network ETH | Type: LAN

MAC address: FC:C2:3D:0E:24:E5

External port for web server: 443

Enable DHCP:

IP address: 192.168.1.108

Netmask: 255.255.255.0

Gateway IP address: 192.168.1.1

Primary DNS: 192.168.1.1

Secondary DNS: 8.8.8.8

Save

Note



Ask the network administrator when operating the web server on a customer's network.

Check the status of the Internet connection in menu 'Plant status' > 'System status' > 'System information'. The same menu also displays if a connection is active to Synco IC.

SIEMENS

Plant status

System info | Event log | Synco IC log | Web access

▼ General status

Internet connection: OK

Current IP address: 138.188.45.241

Web access status: Reachable

Wi-Fi status: Activated

Synco IC reporting: Enabled

Plant name: Room 448 - Productive

Serial number: EV16444144

Model: WTV676-H86035

Time left: 10h 17m 3s

SSID: WTV676-EV16444144

Wi-Fi address: 192.168.0.10

MAC address: 7C:D0:90:C9:1A:1D

Address: Zählerweg 9 - 192.168.1.115

Wi-Fi: Disable

Firmware version: 4.9_2.0_3.1

Web interface version: 3.38

Idle

Idle

1

21/06/2021 13:52

Additional information on WTV remote access is available in section 'Connect web server to PC or LAN', page 39.

Email configuration

The following data must be saved on web server to send emails:

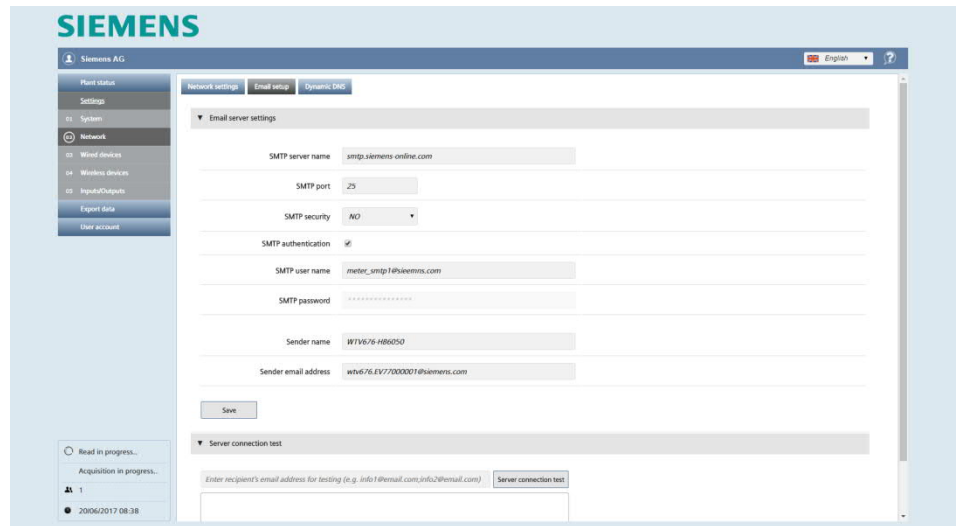

Email server settings

The following email server settings are available:

- SMTP server name: The address for the SMTP server.
- SMTP port: The port number used by the SMTP server.
- SMTP security: Selection of either SSL or TLS security. The setting NO sends the emails without encryption; do not use this setting for security reasons.
- SMTP authentication: Enter whether the SMPT server requires authentication.
- Sender name: Name of the sender that appears in the from email address in the email.
- Sender email address: The email address of the sender

Important



Be careful when changing these settings! Check with your email provider for the required email server settings.

Click **Save** to confirm changes to the above parameters.

Email server settings

You can test the server connection to the email server by sending yourself a report to an email address of your choice.

The results are displayed as soon as the message is sent:

Test result

- Message has been sent successful using SMTP

Note



The settings listed above are required for the web server to send alarms and reports directly by email.

The settings above are not required if web server is integrated in Synco IC (you can query the reports via Synco IC).

Dynamic DNS

The web server can communicate directly with the fixed IP address or domain if a fixed IP address or domain (e.g. www.myname.com) is available for the Internet connection.

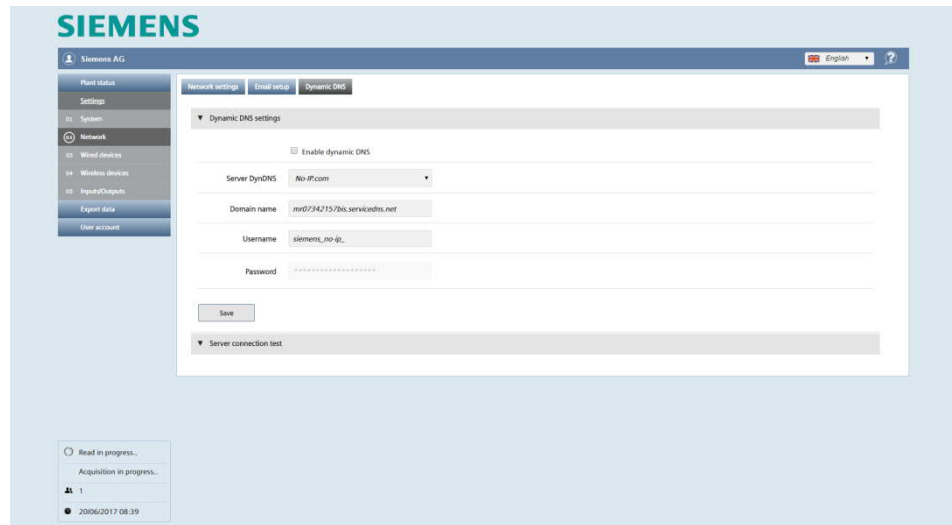

Dynamic DNS settings

DNS servers are available on the Internet for dynamic IP addresses that connect customized domain names with dynamic IP-Addresses of the web server.

Registration

You must first set up an account at the provider to use the DynDNS server.

Report dynamic address

The web server must inform the service of changes to the dynamic IP address for the web server to communicate via the setup DynDNS service. The Dynamic DNS must be set on the web server as follows:

- Enable Dynamic DNS settings: Allows web server to use a dynamic DNS service
- Server DynDNS: The following two Dynamic DNS providers are available:
 - No-IP.com
 - DynDNS.com
- Domain name: Name provided to you by your dynamic DNS supplier.
- Username: Username for accessing the dynamic DNS server
- Password: Password for accessing the dynamic DNS server

Important



Be careful when changing these settings! Ask your network administrator for the required data on network configuration.

Click 'Save' to confirm changes to the above parameters.

Note



Dynamic DNS service must be set up if web server is not connected to Synco IC and WTV remote access is not needed. This ensures that the web server can always be found on the Internet

Server connection test

You can test the connection to the DynDNS server.
The results are displayed.

▼ Server connection test

Last server response ► nochg 85.4.236.248 @2018-05-25 04:55:03

Server No-IP.com response ► nochg 85.4.236.248

12.4.3 Wired devices

Device settings

In this panel, you have access to the device list and can change settings.

Note 

The list is empty if no device search has been run. The devices that are found and saved are displayed on the list after a device search.

SIEMENS

Siemens AG

Plant status

Settings

01 System

02 Network

03 Wired devices

04 Wireless devices

05 Inputs/Outputs

Export data

User account

Device settings Controller settings Device search - M-Bus line M1M2 Device search - M-Bus line ABC

What are you looking for?

Connected devices 2

Medium	M-Bus line	Serial number	Device name	Description	Manufacturer code
Water	M1M2	05474140	DEV_05474140	PA_000	LSE
Warm Water	M1M2	05474141	DEV_05474141	PA_000	LSE

Device name DEV_05474141 (** Scan interval 1 month

Description 1 PA_000 Install date 13/09/2019

Description 2 Primary address 0

ID Device 05474141-32650604 Baudrate 2400

Read by Secondary address Manufacturer code LSE

Medium Warm Water Version (HEX) 04

▼ Data Points settings (**)

▼ Meter alarm settings (**)

Save Select this option to apply the settings marked with (**) to all devices of the same brand and model

The display is structured as follows:

- 1 Search field
- 2 List of all devices found on M-bus
- 3 Data points settings
- 4 Meter alarm settings

Search field

Enter the serial number, device name, or device description to filter by wired M-bus devices.

Press enter to display the search results.

Delete the content of the search field to remove the filter and press enter.

Device list

	Serial number	Device name	Description	Manufacturer code	
Heat	65589679	DEV_65589679	PA_000	LSE	
Cooling energie	65589680	DEV_65589680	PA_000	LSE	
Heat/Cooling	07923586	DEV_07923586	PA_001	LSE	

- First column: Displays the medium
- M-bus line: Displays the M-bus line to which the device is connected. Lines M1M2 and ABC are available.
- Serial number: Displays the meter serial number
- Device name: Displays the meter name as entered under device name
- Description: Displays the text entered under Description 1
- : Indicates that a product image is available for the device.
- Manufacturer code: Displays the 3-letter code of the device manufacturer.
- Delete: Click the trash can to delete the device from the list.

The list of wired devices can be exported as an .xls or .csv file, edited and then re-imported.

It is easier to edit the device information in xls or csv formats, especially when editing the fields for multiple devices.

Click the corresponding icon to export the list:



Serial number	Device name (X)	Description (X)	Manufacturer code	Medium	M-Bus line
7805	PA_000	DEV_00007805	LSZ	Breaker	M1M2
28964	PA_000	DEV_00028964	LSZ	Breaker	M1M2
71725	PA_000	DEV_00071725	WZG	Warm Water	M1M2
65891387	PA_000	DEV_65891387	LSE	Heat	M1M2
66287579	PA_000	DEV_66287579	LUG	Heat	M1M2
67132999	PA_000	DEV_67132999	LUG	Heat	M1M2

Save the changes and import the list using the following icon:



Device settings

Click the device line to view the settings for the device:

Device name	<input type="text" value="DEV_65589680"/>	(**) Scan interval	60 min
Description 1	<input type="text" value="PA_000"/>	Install date	11/09/2016
Description 2	<input type="text"/>	Primary address	0
ID Device	<input type="text" value="65589680"/>	Baudrate	300
Read by	<input type="text" value="Secondary address"/>	Manufacturer code	LSE
Medium	<input type="text" value="Cooling energie"/>	Version (HEX)	29

Siemens



(**) WFN532

Free text settings:

- Device name: You can assign a name to the device (e.g. Apartment 123).
- Description 1: Device description as indicated in the device list.
- Description 2: Additional description
- Scan interval: 15 min. / 60 min., 6 h, 12 h, 1 day, 7 days, 1 month
- Installation date.
- The device image can be set by clicking the as needed. You can select the appropriate image from the web server device database.

Click 'Save' to save the edited values.

Note



Query intervals are required to generate reports. A query interval can be individually defined for each device. The interval determines the intervals at which the device read outs are saved.

Additional information on query intervals is available in Section 'Creating reports', pg. 116.

Settings that cannot be changed:

- ID Device: Displays the device serial number
- Read by: Displays whether the meter is read via the primary or secondary address.
- Medium: Displays the medium measured by the device.
- Primary address: Displays the device's primary address (1...250)
- Baud rate: Displays the transmission rate between the device and web server.
- Manufacturer code: Displays the manufacturer's code (if included in the database).
- Version (HEX): Displays the device version.

Data Points settings

SIEMENS

Devices list

Device name	<input type="text" value="DEV_65589680"/>	(**) Scan interval	60 min
Description 1	<input type="text" value="PA_000"/>	Install date	11/09/2016
Description 2	<input type="text" value="text"/>	Primary address	0
ID Device	<input type="text" value="65589680"/>	Baudrate	300
Read by	<input type="text" value="Secondary address"/>	Manufacturer code	LSE
Medium	<input type="text" value="Cooling energie"/>	Version (HEX)	29

Siemens



(**) WFN532

▼ Data Points settings (**)

Main Value	User description	M bus description	Standard Report	Data point mapping	Custom Report	Data point to be included	Trend report	Data point to be included in
<input type="checkbox"/>	Flow measure interval	Actualization	none	<input type="text" value=""/>	<input type="checkbox"/>	<input type="checkbox"/>	<input type="checkbox"/>	<input type="checkbox"/>
<input type="checkbox"/>	Flow measure interval	Averaging duration	none	<input type="text" value=""/>	<input type="checkbox"/>	<input type="checkbox"/>	<input type="checkbox"/>	<input type="checkbox"/>
<input checked="" type="checkbox"/>	Flow energy consumption	Energy	none	<input type="text" value=""/>	<input checked="" type="checkbox"/>	<input checked="" type="checkbox"/>	<input checked="" type="checkbox"/>	<input type="checkbox"/>
<input type="checkbox"/>	Total power	Wattage	none	<input type="text" value=""/>	<input type="checkbox"/>	<input type="checkbox"/>	<input type="checkbox"/>	<input type="checkbox"/>
<input type="checkbox"/>	Load power	Power	none	<input type="text" value=""/>	<input type="checkbox"/>	<input type="checkbox"/>	<input type="checkbox"/>	<input type="checkbox"/>
<input type="checkbox"/>	Inverter	Wattage/VA	none	<input type="text" value=""/>	<input type="checkbox"/>	<input type="checkbox"/>	<input type="checkbox"/>	<input type="checkbox"/>
<input type="checkbox"/>	Flow temperature	Flow Temperature	none	<input type="text" value=""/>	<input type="checkbox"/>	<input type="checkbox"/>	<input type="checkbox"/>	<input type="checkbox"/>
<input type="checkbox"/>	Room temperature	Room Temperature	none	<input type="text" value=""/>	<input type="checkbox"/>	<input type="checkbox"/>	<input type="checkbox"/>	<input type="checkbox"/>

- Main Value: You can select the value for display on the **Plant status/Wired devices** overview (see page 69).

- User description: The data point designation can be edited.
- M-bus description: Data point designation as per the M-bus specification
- Standard report – Data point mapping: Assigns data points to predefined columns on the standard report. Only one data point can be assigned to a specific column for each device. Data points with the "none" setting are not displayed in the standard report.
- Custom Report – Data point to be included: Select the data points to be included in the custom report.
- Trend report – Data point to be included (x): Select the data points for inclusion in the trend file. The (x) selects all checkboxes for the entire column.
- "...":

Energy	Energy	none	...
Multiplier	0.1		
Storage	0		
Subunit	0		
Tariff	0		
Type value	Instantaneous Value		
Units	kWh		

Click the "... " column to display additional details (Multiplier, Storage, Subunit, Tariff, Type value und Units) on the selected data point. The details can help you come up with a meaningful user description.

Click **Save** to save the edited settings.

Alarm settings meters

Each device as a series of error messages available to it over M-bus.

The following information and settings are available.

- LOG: Displays whether the error message was registered in the event log.
- Email: Displays whether an email was sent due to the error message.
- Event name: The event name is predefined. It can, however, be changed as needed.
- Event type: Displays the event type received from the device.
- Status: Displays whether the alarm is active or not active.

LOG	Email	Event name	Event type	Status	...
<input checked="" type="checkbox"/>	<input checked="" type="checkbox"/>	<input type="text" value="application_busy (*)"/>	M-bus status notification	Not active	...

Actions Add to log Send email

Input condition

Bit 8	Bit 7	Bit 6	Bit 5	Bit 4	Bit 3	Bit 2	Bit 1
<input type="checkbox"/>	<input type="checkbox"/>	<input type="checkbox"/>	<input type="checkbox"/>	<input type="checkbox"/>	<input type="checkbox"/>	<input type="checkbox"/>	<input checked="" type="checkbox"/>

Click "... " to open a new pane with the following settings:

- Actions:
 - Add to log: Select whether this alarm is added to the event log.
 - Send email: Select whether notification is sent by email when this alarm occurs.
- Input conditions:

You can select the bit from the M-bus status byte for the device that represents the corresponding alarm notification.

Click **Save** to apply the alarm settings. You must confirm to apply the settings!

Note



Settings identified by (**) can transfer the settings to all devices of one type by selecting the check box if multiple devices of the same type are installed on the plant.

Save

Select this option to apply the settings marked with (**) to all devices of the same brand and model

Controller settings

In this panel, you have access to the device list (controllers) and can change settings.

Note



The list is empty if no device search has been run. The devices that are found and saved are displayed on the list after a device search.

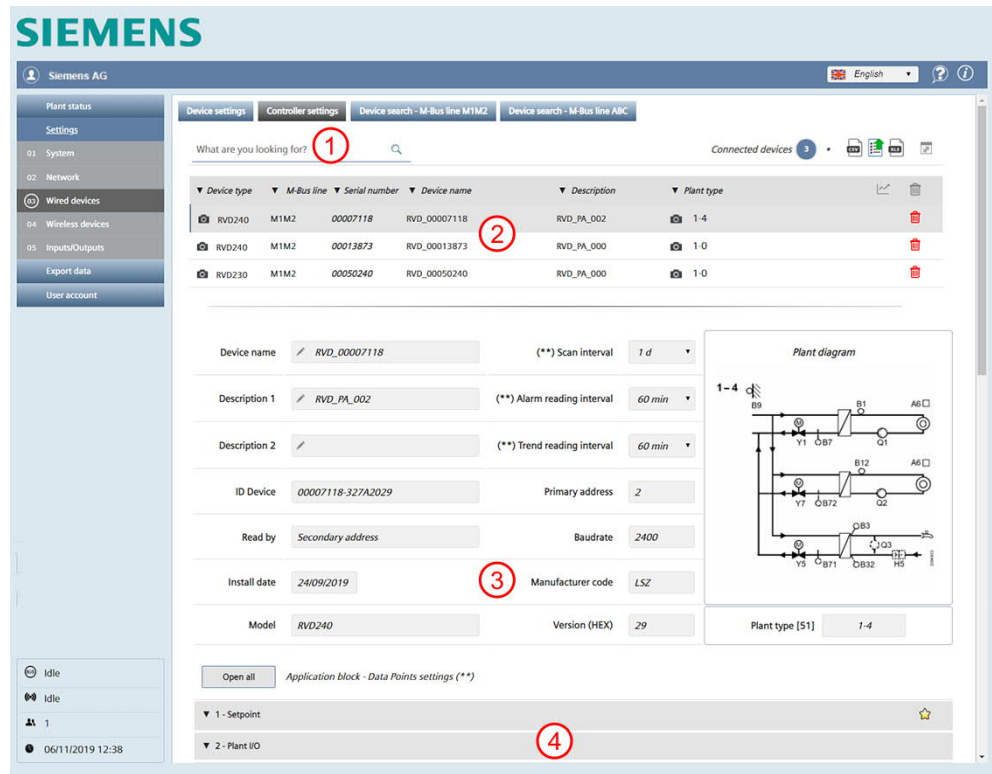

The display is structured as follows:

- ① Search field
- ② List of all controllers (device list) found on M-bus
- ③ Settings that can be edited (Device details)
- ④ Data point settings

Search field

Enter the serial number, device name, or device description in the search field to filter by devices.

Press enter to display the search results.

Delete the content of the search field to remove the filter and press enter.

Device list

Device type	M-Bus line	Serial number	Device name	Description	Plant type
RVD240	M1M2	00007118	RVD_00007118	RVD_PA_002	1-4
RVD240	M1M2	00013873	RVD_00013873	RVD_PA_000	1-0
RVD230	M1M2	00050240	RVD_00050240	RVD_PA_000	1-0

- First column: Displays the medium
- M-bus line: Displays the M-bus line to which the device is connected. Lines M1M2 and ABC are available.
- Serial number: Displays the device serial number
- Device name: Displays the device name as entered under device name
- Description: Displays the text entered under Description 1
- Plant type: Displays the plant type. The number of the plant diagram is displayed to the right of the symbol.
- Delete: Click the trash can to delete the device from the list.

The list of controllers can be exported as an .xls or .csv file, edited and then re-imported.

It is easier to edit the device information in xls or csv formats, especially when editing the fields for multiple devices.

Click the corresponding icon to export the list:



You can edit the fields in the columns 'Device name (X)' and 'Description (X)'.

Serial number	Device name (X)	Description (X)	Device type	Plant type	M-Bus line
00007118	RVD_00007118	RVD_PA_002	RVD240	1-4	M1M2
00013873	RVD_00013873	RVD_PA_000	RVD240	1-0	M1M2
00050240	RVD_00050240	RVD_PA_000	RVD230	1-0	M1M2

Save the changes and import the list using the following icon:



Device details

Click the device line to view all settings for the device that can be edited:

RVD230
M1M2
00050240
RVD_00050240
RVD_PA_000
1-0
🗑️

Device name <input type="text" value="RVD_00050240"/>	(**) Scan interval	<input type="text" value="1 d"/>	<div style="border: 1px solid #ccc; padding: 5px;"> <p style="text-align: center; margin: 0;">Plant diagram</p> </div>
Description 1 <input type="text" value="RVD_PA_000"/>	(**) Alarm reading interval	<input type="text" value="60 min"/>	
Description 2 <input type="text"/>	(**) Trend reading interval	<input type="text" value="60 min"/>	
ID Device <input type="text" value="00050240-327A2029"/>	Primary address	<input type="text" value="0"/>	
Read by <input type="text" value="Secondary address"/>	Baudrate	<input type="text" value="2400"/>	
Install date <input type="text" value="13/09/2019"/>	Manufacturer code	<input type="text" value="LSZ"/>	
Model <input type="text" value="RVD230"/>	Version (HEX)	<input type="text" value="29"/>	

Plant type [51]

Free text settings:

- Device name: You can assign a name to the device (e.g. Apartment 123).
- Description 1: Device description as indicated in the device list under 'Description' (e.g. Apartment 123).
- Description 2: Additional description
- Scan interval: 60 min., 6 h, 12 h, 1 day, 7 days, 1 month
- Alarm read out interval: 60 min, 6 h, 12 h, 1 day, 7 days
- Installation date
- Trend read interval: 15 min / 60 min, 6 h, 12 h, 1 day, 7 days, 1 month

Click 'Save' to save the edited values.



Query intervals are required to generate reports. A query interval can be individually defined for each device. The interval determines the intervals at which the device read outs are saved. Additional information on query intervals is available in Section 'Creating reports', pg. 116.

Settings that cannot be changed:

- ID Device: Displays the device serial number
- Read by: Displays whether the device is read via the primary or secondary address.
- Medium: Displays the medium measured by the device.
- Primary address: Displays the device's primary address (1...250)
- Baud rate: Displays the transmission rate between the device and web server.
- Manufacturer code: Displays the manufacturer's code (if included in the database).
- Version (HEX): Displays the device version.
- Plant diagram: Displays the plant type.

Data point settings

Open all Application block - Data Points settings (**)

- ▼ 1 - Setpoint
- ▼ 2 - Plant I/O
- ▼ 3 - Device identification and errors
- ▼ 4 - Global configuration
- ▼ 5 - Device configuration
- ▼ 6 - Heat circuit 1 and 2
- ▼ 8 - Connection settings
- ▼ 9 - Load Management
- ▼ 10 - Switching program for heat circuit 1
- ▼ 13 - Service

Save Select this option to apply the settings marked with (**) to all devices of the same brand and model

The following application blocks are available:

- 1. Setpoint
- 2. Plant I/O
- 3. Device ID and error
- 4. General configuration
- 5. Device configuration
- 6. Heating circuit 1 and 2
- 7. DHW
- 8. Connection settings
- 9. Load management
- 10. Scheduler program for heating circuit 1
- 11. Scheduler program for heating circuit 2
- 12. Scheduler program for DHW
- 13. Service

Click button 'Open all' to expand all application block and display individual data points (drop-down list).

Select the data points (check box) for inclusion in the trend file.

You can set a data point as the main value for each application block. The main value is displayed in the overview 'Plant state' > 'Controller'. See section 'Wired devices' as of pg. 89.

Clicking button 'Close all' hides the data points on all the application blocks.

Note  Plant type determines which application blocks are enabled and which data points are shown.

Click 'Save' to save the edited settings.

Note  If multiple devices of the same type (make and model) are installed on a plant, settings identified by (**) can be transmitted by selecting the checkbox on all devices of this type.

Note  We recommend creating a backup after commissioning and setting the parameters. This backup can restore the configuration at any time. Additional information on creating a backup is available in section 'Create backup file', page 74.

Device search

You can select the M-bus line to scan for the device search.

You can either perform the device search individually on line M1M2 or line ABC respectively, or search both lines in parallel.

You can also select whether to use the default settings or whether to search by specific criteria.

Total devices found: Displays the number of meter and number of controllers.

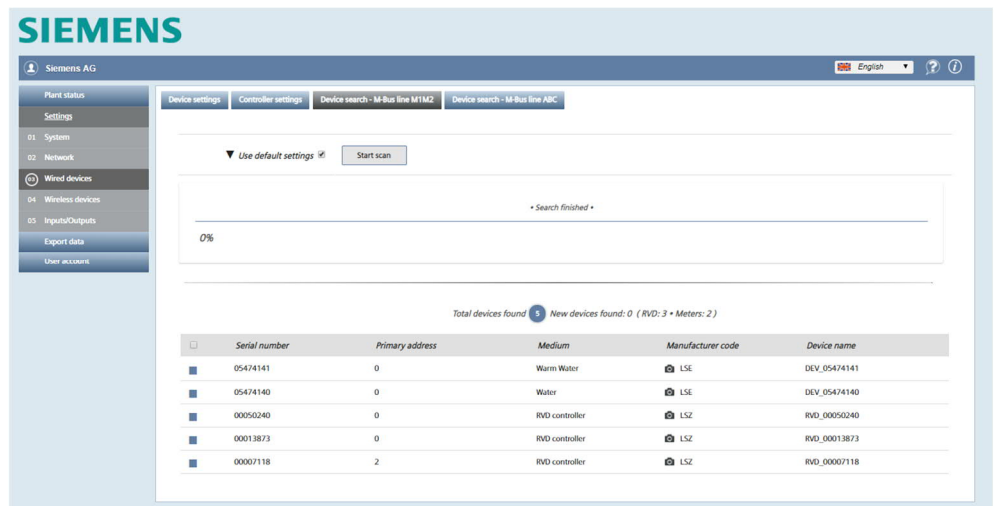

Serial number	Primary address	Medium	Manufacturer code	Device name
05474141	0	Warm Water	LSE	DEV_05474141
05474140	0	Water	LSE	DEV_05474140
00050240	0	RVD controller	LSZ	RVD_00050240
00013873	0	RVD controller	LSZ	RVD_00013873
00007118	2	RVD controller	LSZ	RVD_00007118

The entire bus is scanned for connected M-bus devices if **Use default settings** is selected and you click **Start scan**.

Note  Start by scanning with **Use default settings**. Only use the customized device search if the search by default settings fails to recognize one or more devices. This can be the case if a data collision occurs on the bus during the automatic search or if the device does not operate at the standard baud rate (refer to the device documentation for the data).

Web server searches for devices by the secondary address at a baud rate of 2400 bps.

Customized search
M-bus-line M1M2
M-bus line ABC

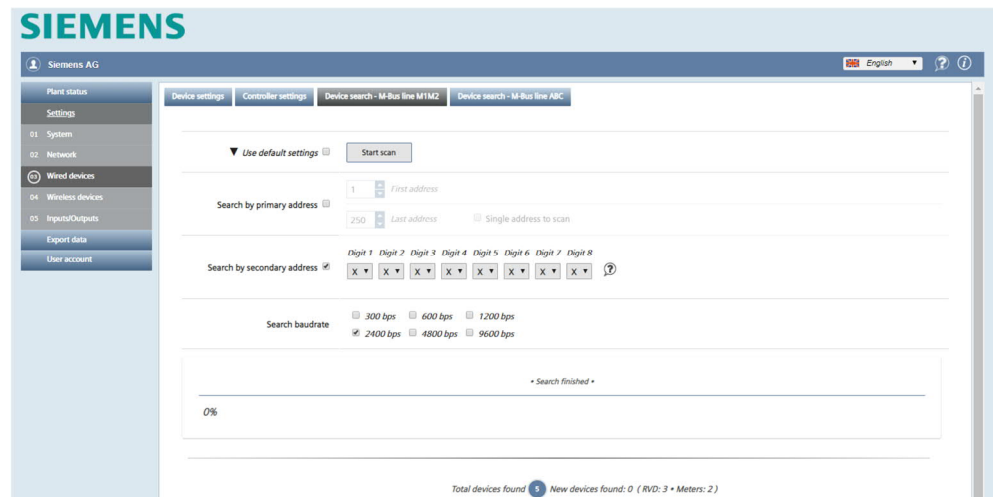

You can customize a search to search on both M-bus lines by the following criteria:

- Primary address
- Secondary address
- Baud rate

Search by primary address:

You can select or clear a search by primary address.

- First address: You can define the start address for the search.
- Last address: You can define the end address for the search.
- Single address to scan: You can scan by a specific primary address.

Search by secondary address:

You can select or clear a search by secondary address (serial number).

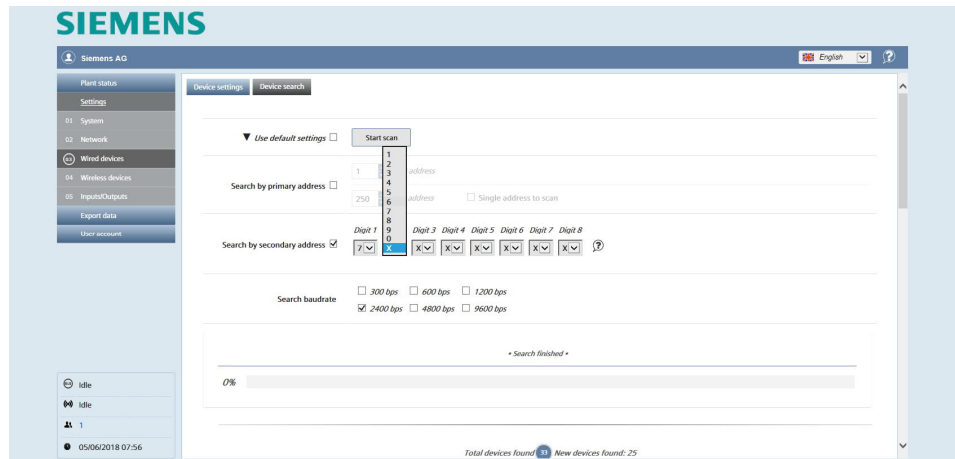

To shorten the search time, you can limit the search range for secondary addresses using the settings for Digit 1 through Digit 8.

Search baud rate:

You can enter the corresponding baud rate for the device search if devices deviate from the default baud rate (refer to the device documentation for the baud rate).

You can search for devices by a specific baud rate (300 / 600 / 1200 / 2400 / 4800 / 9600 bps).

Multiple baud rates can be selected as well. The device search is longer, if multiple baud rates are selected at the same time.

Click **Start scan**.

Progress is indicated by the progress bar.

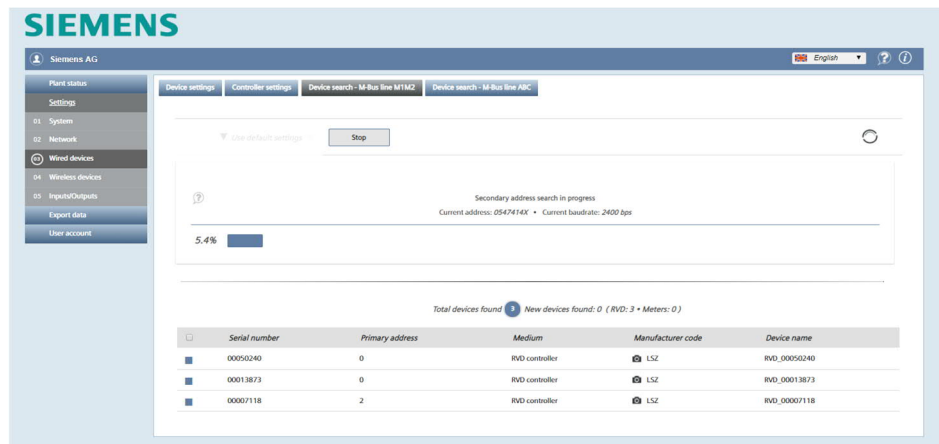

Search results

All found devices are listed at the conclusion of the device search. Select one or more devices and **Add**, to add the new devices to the device list.

Important



Devices that are not saved are rejected.

The following must be listed at a minimum for any found device:

- Serial number
- Primary address
- Medium
- Manufacturer code with optional device image
- Automatically generated device name

12.4.4 Wireless devices

Device settings

In this panel, you have access to the list of wireless devices and can change settings.

Note



The list is empty if no device search has been run. The meters that are found and saved are displayed on the list after a device search.

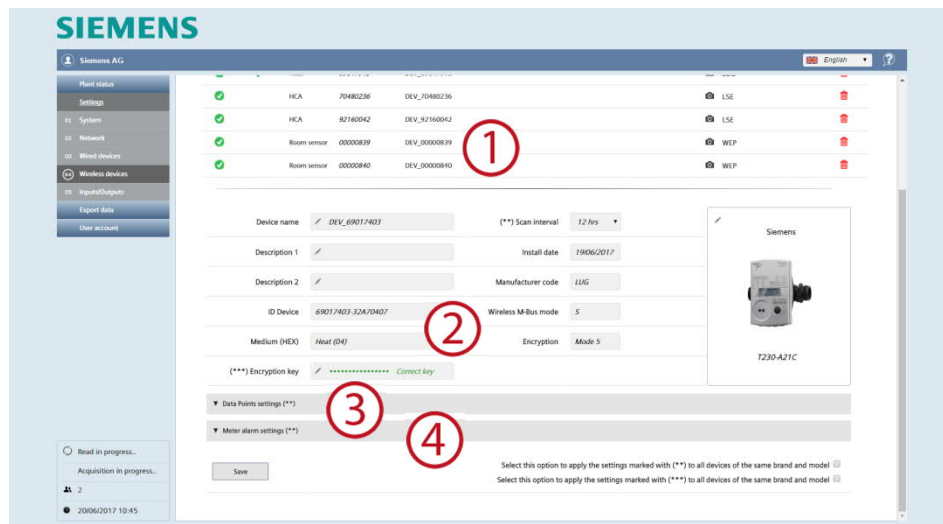

The display is structured as follows:

- ① List of all devices found on M-bus
- ② Device settings
- ③ Data points settings
- ④ Meter alarm settings

Device list

Log	Encryption	Medium	Serial number	Device name	Description	Manufacturer code	
✓	🔒	Heat	69017403	DEV_69017403		LUG	🗑️
✓	🔒	Heat	69017404	DEV_69017404		LUG	🗑️
✓	🔒	Heat	69017915	DEV_69017915		LUG	🗑️
✓		HCA	70480236	DEV_70480236		LSE	🗑️
✓		HCA	92160042	DEV_92160042		LSE	🗑️
✓		Room sensor	00000839	DEV_00000839		WEP	🗑️
✓		Room sensor	00000840	DEV_00000840		WEP	🗑️

- First column: Indicates whether the device was accepted or not
- Encryption: Indicates whether the device is encrypted
- Medium: Displays the medium
- Serial number: Displays the meter serial number
- Device name: Displays the meter name as entered under device name
- Description: Displays the text entered under Description 1
- 📷 : Indicates that a product image is available for the device.
- Manufacturer code: Displays the 3-letter code of the device manufacturer.
- Delete: Click the trash can to delete the device from the list.

The list of wireless devices can be exported as an .xls or .csv file. Click the corresponding symbol:

The list of wireless devices can be exported as an .xls or .csv file, edited and then re-imported.

It is easier to edit the device information in xls or csv formats, especially when editing the fields or multiple devices.

Click the corresponding icon to export the list:



You can edit fields in the Device name (X) and Description (X) columns.

Serial number	Device name (X)	Description (X)	Manufacturer code	Medium	AES Key	Current status
65707854		DEV_65707854	LSE	Heat	NO	OK
57794606		DEV_57794606	LSE	Water	NO	OK
57794605		DEV_57794605	LSE	Water	NO	OK
90546092		DEV_90546092	LSE	HCA	NO	OK
90546089		DEV_90546089	LSE	HCA	NO	OK
65707855		DEV_65707855	LSE	Cooling energy	NO	OK

Save the changes and import the list using the following icon:



Device settings

Click the device line to view the settings for the device:

Device name	<input type="text" value="DEV_65589680"/>	(**) Scan interval	<input type="text" value="60 min"/>	Siemens
Description 1	<input type="text" value="PA_000"/>	Install date	<input type="text" value="11/09/2016"/>	 <p>(**) WFN532</p>
Description 2	<input type="text"/>	Primary address	<input type="text" value="0"/>	
ID Device	<input type="text" value="65589680"/>	Baudrate	<input type="text" value="300"/>	
Read by	<input type="text" value="Secondary address"/>	Manufacturer code	<input type="text" value="LSE"/>	
Medium	<input type="text" value="Cooling energie"/>	Version (HEX)	<input type="text" value="29"/>	

Free text settings:

- Device name: You can assign a name to the device (e.g. Apartment 123).
- Description 1: Device description as indicated in the device list.
- Description 2: Additional description
- Scan interval: 15 min. / 60 min., 6 h, 12 h, 1 day, 7 days, 1 month
- Installation date.
- The device image can be set by clicking the  as needed. You can select the appropriate image from the web server device database.

Click **Save** to save the edited values.

Note



Query intervals are required to generate reports. A query interval can be individually defined for each device. The interval determines the intervals at which the device read outs are saved.

Additional information on query intervals is available in Section 'Creating reports', pg. 116.

Settings that cannot be changed:

- ID Device: Displays the device serial number
- Medium (HEX): Displays the medium measured by the device.
- Manufacturer code: Displays the manufacturer's code (if included in the database).
- Radio mode: Indicates the device's radio mode.
- Encryption: Indicates whether encryption is enabled or disabled
- Encryption key: AES-128 key for encrypting messages.

Data Points settings

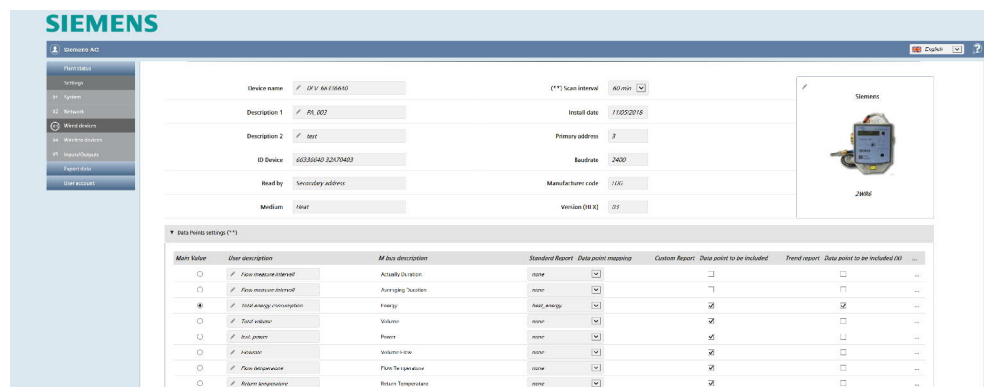

- Main Value: You can select the value for display on the **Plant status/Wireless** overview (see page 69).
- User description: The data point designation can be edited.
- M-bus description: Data point designation as per the M-bus specification
- Standard report – Data point mapping: Assigns data points to predefined columns on the standard report. Only one data point can be assigned to a specific column for each device. Data points with the "none" setting are not displayed in the standard report.
- Custom Report – Data point to be included: Select the data points to be included in the custom report.
- Trend report – Data point to be Included (x): Select the data points for inclusion in the trend file. The (x) enables all check boxes for the entire column.
- "...":
- Click the "... " column to display additional details (Storage, Subunit, Tariff, Type value) on the selected data point. The details can help you come up with a meaningful user description.

Killobenrue	Energy	Acut_energy
Multiplier	0.1	
Storage	0	
Subunit	0	
UnitID	0	
Type value	Instantaneous Value	
Units	kWh	

Alarm settings meters

Each device as a series of error messages available to it over M-bus.

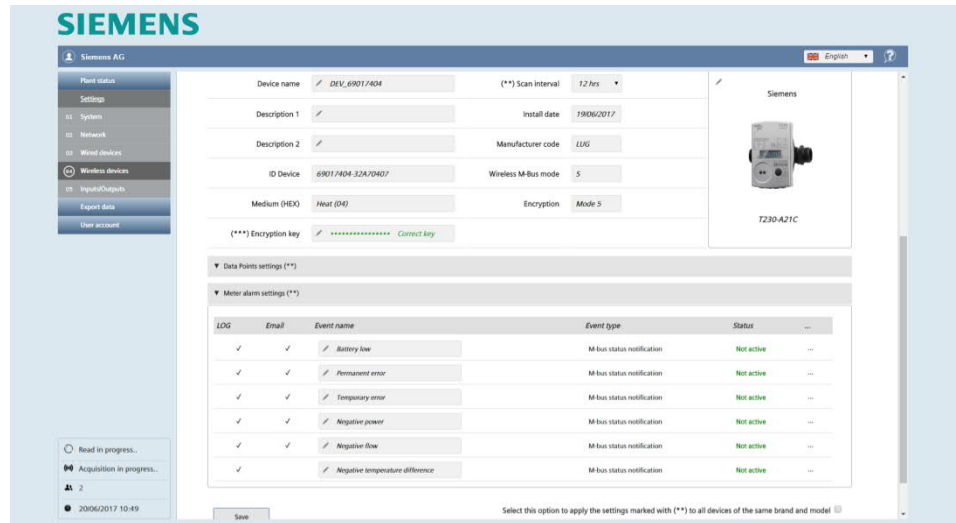

The following information and settings are available.

- LOG: Displays whether the error message was registered in the event log.
- Email: Displays whether an email was sent due to the error message.
- Event name: The event name is predefined. It can, however, be changed as needed.
- Event type: Displays the event type received from the device.
- Status: Displays whether the alarm is active or not active.

LOG	Email	Event name	Event type	Status	...
<input checked="" type="checkbox"/>	<input checked="" type="checkbox"/>	<input type="text" value="application_busy (*)"/>	M-bus status notification	Not active	...

Actions Add to log Send email

Input condition Bit 8 Bit 7 Bit 6 Bit 5 Bit 4 Bit 3 Bit 2 Bit 1

Click "... " to open a new pane with the following settings:

- Actions:
 - Add to log: Select whether this alarm is added to the event log.
 - Send email: Select whether notification is sent by email when this alarm occurs.
- Input conditions:

You can select the bit from the M-bus status byte for the device that represents the corresponding alarm notification.

Click **Save** to apply the alarm settings. You must confirm to apply the settings!

Note

i Settings identified by (**) can transfer the settings to all device of one type by selecting the check box if multiple meters of the same type are installed on the plant.

Save

Select this option to apply the settings marked with (**) to all devices of the same brand and model

Device search

For device search, you can select whether to search for an RF converter on a specific mesh network or for a wireless meter that communicates with a specific RF converter within an M-bus radio network.

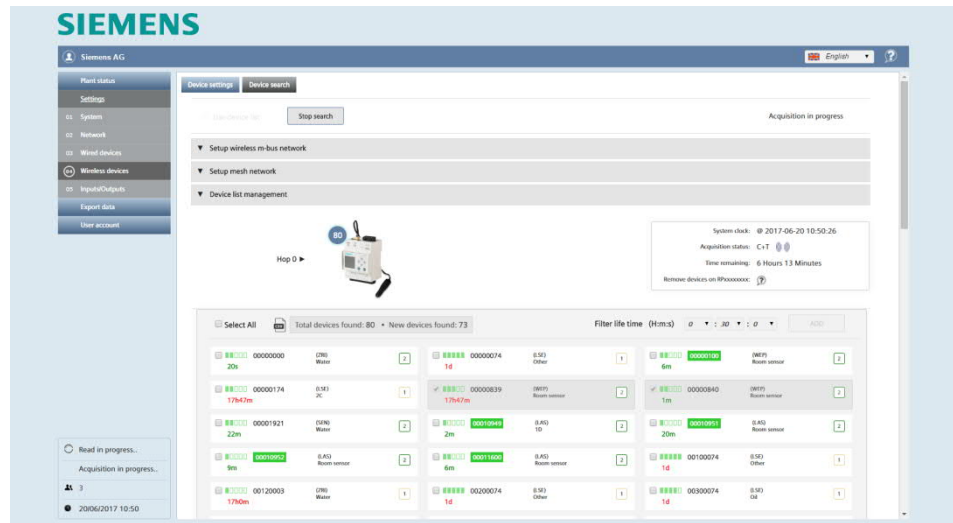

Configure M-bus network

The RF converter and wireless devices communication over the M-bus wireless network.

Settings that can be freely edited:

- Global encryption key: The global encryption is used during the automatic search.
- Global AES Key 1: The global encryption key is used during the automatic search.
- Global AES Key 2: The global encryption key is used during automatic search.
- M-bus wireless operation mode: You can enter the M-bus operation mode. The following values are available: C+T, S, T, C+ T, S & C + T. You can further limit the search to devices in installation mode only (SND_IR).
- Acquisition phase duration: You can enter the duration of the device search in hours (1 to 24).

Click **Save** to save the changed values.

Setup wireless m-bus network

Enable global encryption key

Global AES Key 1:

Global AES Key 2:

Operating Modes of Wireless M-Bus: S & C+T During the scan, accept only devices that transmit in Installation mode (SND_IR) Read devices with walk-by telegrams only

Acquisition phase duration: 12 Hours

Option

You can select both check boxes as an option to further limit the device scan:

- "During this scan, accept only devices that transmit in Installation mode (SND_IR)": Use this function for plant extension or when exchanging devices. The scan is only by new devices in installation mode.

"Read device with walk-by telegrams only": This function is only used to scan for devices that communicate in walk-by mode. The goal is for remote readout of walk-by device over web server access.

Configure mesh network

Web server and RF converters communicated over a mesh RF protocol (Backbone network).

Settings that can be freely edited:

- Mesh ID: You can enter the mesh ID for the mesh network. Ensure that all RF converters are on the same mesh network.
- Channel: For faults, you can enter the channel ID for the desired RF converter.

Click **Save** to save the changed values.



Click **Start search** to start the search.

The wireless symbol flashes while searching.



Search results

All found devices are listed at the conclusion of the device search. Select one or more devices and click **Add**, to add the new devices to the device list.

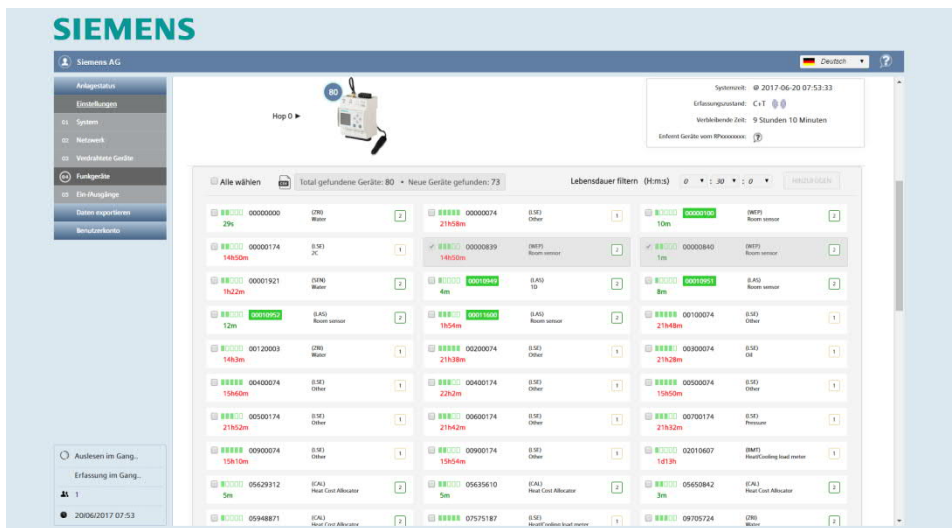

Device list management

You can add the devices to the device list that were newly found or need to be considered.

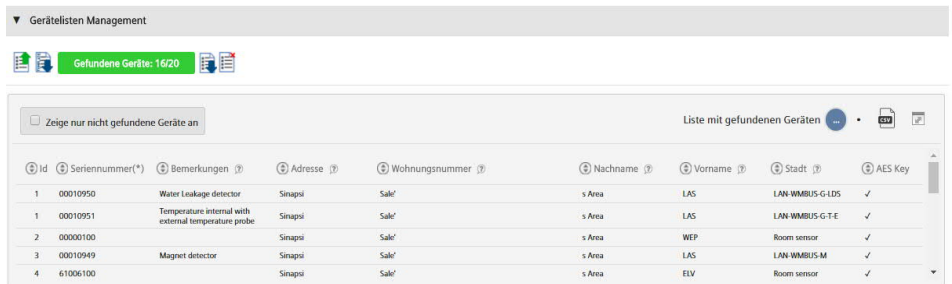

Id	Serialnummer(*)	Bemerkungen	Adresse	Wohnungsnummer	Nachname	Vorname	Stadt	AES Key
1	00010950	Water Leakage detector	Sinapsi	Sale	s Area	LAS	LAN-WMBUS-G-LDS	✓
1	00010951	Temperature internal with external temperature probe	Sinapsi	Sale	s Area	LAS	LAN-WMBUS-G-T-E	✓
2	00000100		Sinapsi	Sale	s Area	WEP	Room sensor	✓
3	00010949	Magnet detector	Sinapsi	Sale	s Area	LAS	LAN-WMBUS-M	✓
4	01006100		Sinapsi	Sale	s Area	ELV	Room sensor	✓

Important



Devices that are not saved are rejected.

The following must be listed at a minimum for any found device:

- Serial number
- Medium
- Manufacturer code with optional device image
- Automatically generated device name

12.4.5 Inputs/outputs

The web server has three digital inputs (I1, I2, I3) and 2 digital outputs (O1, O2).

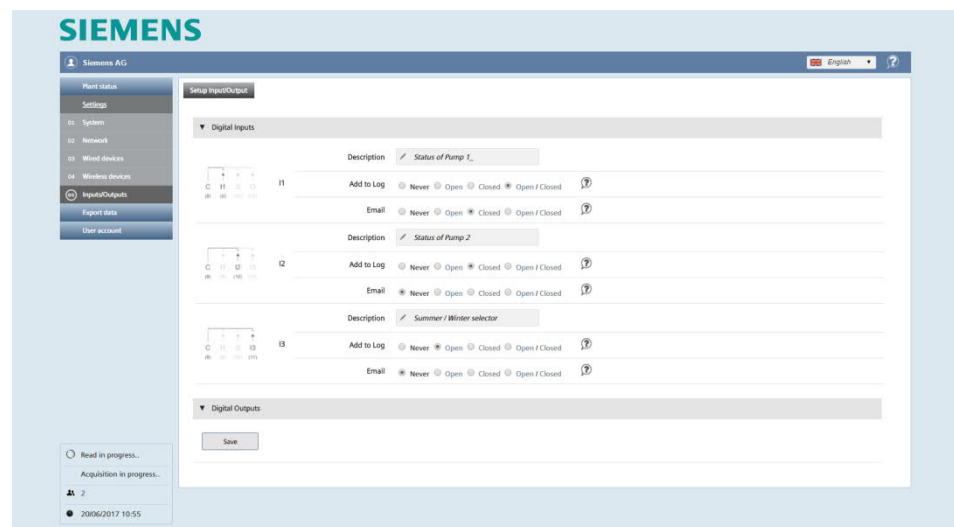

Digital inputs/outputs

The following settings are possible on each digital input and output:

- Description: Each input/output can be labeled with an individual name.
- Add to log: Select whether to log a change of state to an input/output in the event log:
 - Never
 - Open: Only if the state is open or changes to open.
 - Closed: Only if the state is closed or changes to closed.
 - Open/close: For any change of state.
- Email: Select whether to send an email (see **Settings / System / Alarms**), if the input/output registers a change of state:
 - Never
 - Open: Only if the state is open or changes to open.
 - Closed: Only if the state is closed or changes to closed.
 - Open/close: For any change of state.

You can also select the output state for an output after a loss of power:

- Hold the last output state.
- Set to default state "open".

Click **Save** to save the edited settings.

12.5 Export data

Data logged by web server on one or more devices can be exported as a report for further processing.

There are two ways to create a report:

- Manual reports
- Automatic reports

12.5.1 Manual reports

Create report

The meter must first be read to create a report. Click **Read now** to read the device.

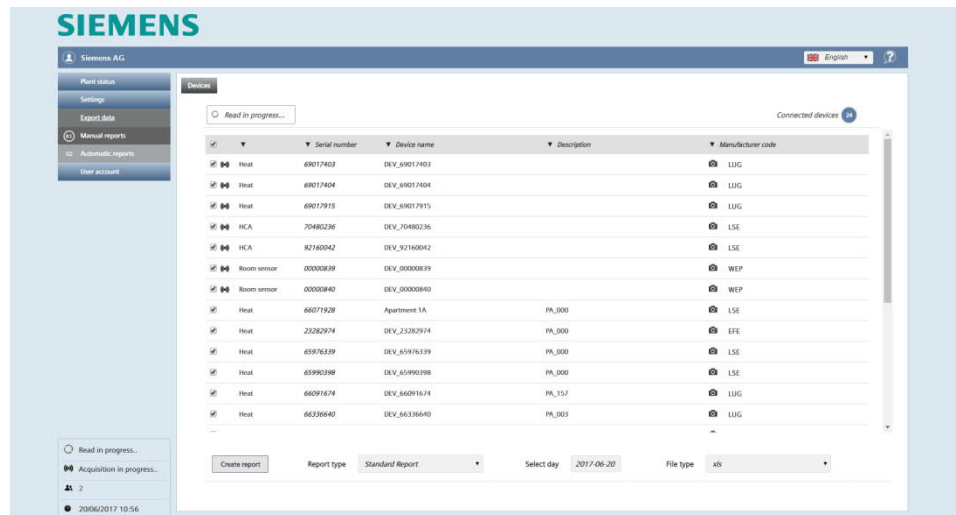

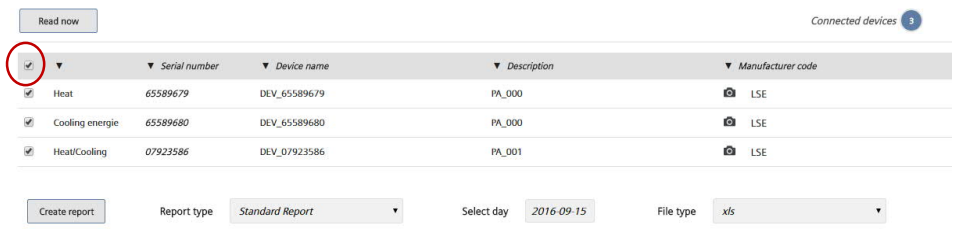

Select the devices to be included in the report.

Select the check box in the title line to select all the devices on the list.



Note

 To simplify the search for the desired device, sort the list alphabetically by clicking .

The following selections need to be made before you can generate the report:

- Report type: Select between:
 - Standard report:
This report includes only the data points on devices that were assigned a standard column in the device settings.
 - Custom report:
This report includes only data points on devices selected in the Custom report column in device settings.
 - Report all data:
This report includes all data points from all devices.
 - Trend report:
The report includes only the data points selected in the device settings in the "Trend file" column. A history trend file includes an evaluation of meter data in the past. History trend files can be created in the "Manual reports" menu. Trend files in the future are created in the "Automatic reports" menu. Additional information is available in Section 'Creating reports', pg, 116.
- Select day: Select the read date (start date) of device data used for the report. The current date is always the default date. You can also select a date in the past. The selection applies to report types "Standard Report", "Custom Report" and "All Data Report".
- For history trend files, set a start and end date with start and end time. A start and end data in the future is not permitted for history trend files. The number of read outs is in red font if the entry is erroneous. The number of read outs is also in red font is the selected timeframe for read outs is too large. Shorten the timeframe in this case or reduce the number of data points.

Note



Report type: Start date: Start time: :
 End date: End time: :
Trend report summary
Devices No: 3
Data point No: 3
Meter readout interval: 1hrs
Readout No: 0

- File type: Select one of the following file formats:
 - .csv format: Exports the data as a .csv file.
 - .xls format: Exports the data as an .xls file.
 - .txt format: Exports the data as a .txt file.

Click **Create report** to generate the report and start the download. The filename is automatically generated.

Additional information on the various report types is available in section "Creating reports", page 116.

12.5.2 Setup automatic reports

Setup automatic reports

Read and post now immediately reads all the devices on the overview list and sends the data per the settings below.

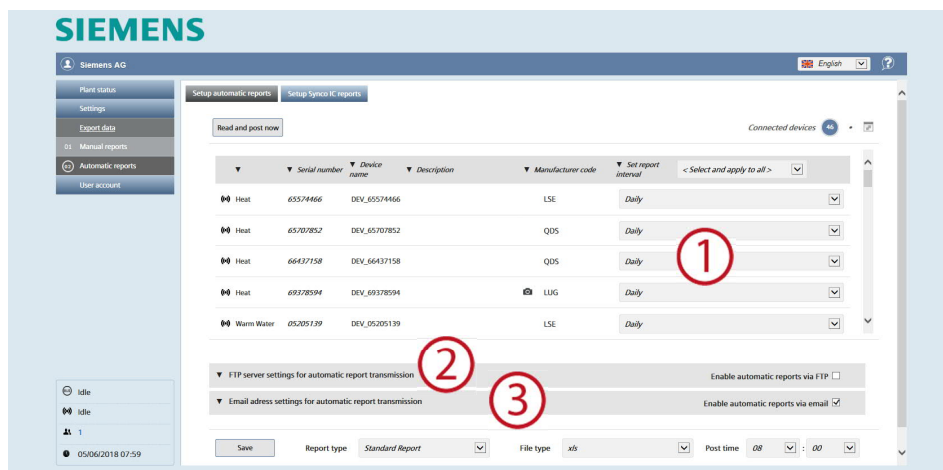

The following data is available on each device:

- Medium
- Serial number
- Device name
- Description
- Manufacturer code
- Report interval

① Report interval

Select the interval for generating a report.

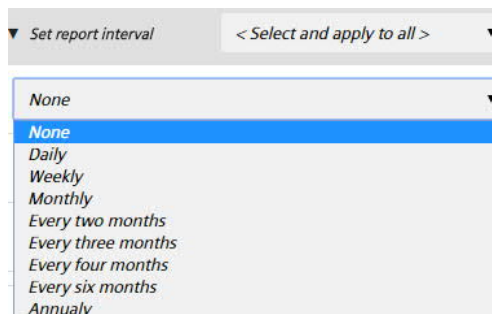

The following options are available:

None: No report is generated.

- Daily: The report is generated daily at “post time” for the previous 24 hours.
- Weekly: The report is generated on Monday at “post time” for the last week.
- Monthly: The report is generated on the last day of the month at “post time”.
- All 2 months: The report is generated on the last day of the second month at “post time” for the last two months.
- All 3 months: The report is generated on the last day of the third month at “post time” for the last three months.
- All 4 months: The report is generated on the last day of the fourth month at “post time” for the last four months.
- All 6 months: The report is generated on the last day of the sixth month at “post time” for the last six months.

- Annually: The report is generated on the last day of the year at midnight for the previous year.

Selecting a report interval in the title applies the setting to all devices on the list.

Click **Save** to save your entries.

② Set up FTP server for automatic report transmission

Select **Enable automatic reports via FTP** if each report is sent to an FTP server and enter the FTP server information.

- FTP server name: Enter the address for the FTP server
- Path (Remote): You can enter a path on the FTP server for saving reports.
- FTP server port: Enter the port for the FTP server
- FTP protocol: Select the FTP protocol. The following protocols are available:
 - SFTP – File Transfer Protocol (SSH)
 - FTP – File Transfer Protocol (TLS)
 - FTP – Unencrypted (unsecured)

We recommend against using “FTP- unencrypted” for security reasons.
- Username: Username to access the FTP server.
- Password: Password for FTP server access

Click **Server connection test** to test the connection to the FTP server. The file ftp_test_connection.txt is saved to the FTP server.

Click **Save** to save your entries.

③ Set up email address for automatic report transmission

Select **Enable automatic reports via email** to send a report to one or more email addresses and enter the corresponding email addresses including the subject line.

Email address settings for automatic report transmission		Enable automatic reports via email <input type="checkbox"/>
To:	support.metering.ch@siemens.com	
Cc:	Enter recipient's email address (e.g. info1@email.com;info2@email.com)	
Bcc:	Enter recipient's email address (e.g. info1@email.com;info2@email.com)	
Subject:	Consumption data overview	

You can separate individual addresses with the semicolon (;) if a report is sent to multiple addresses.

Click **Save** to save your entries.

The following settings are required to generate automatic reports:

- Report type: Select between (for details, see “Manual reports”, page 107):
 - Standard report
 - Custom report
 - Report "All data"

Additional information on the various report types is available in Section “Creating reports”, page 116.

- File type: Select one of the following file formats:
 - .csv format: Exports the data as a .csv file.
 - .xls format: Exports the data as an .xls file.
 - .txt format: Exports the data as a .txt file.
- Post time: The time the readout of the selected devices is performed and the report file is generated and sent out.

Please note that this can take several minutes depending on the number of devices and the M-bus baud rate.

Click **Save** to save your entries.

Set up Synco IC reports In addition to automatic transmission of reports per FTP server and email, reports can also be transmitted automatically to the cloud Synco IC and stored at a centralized location.

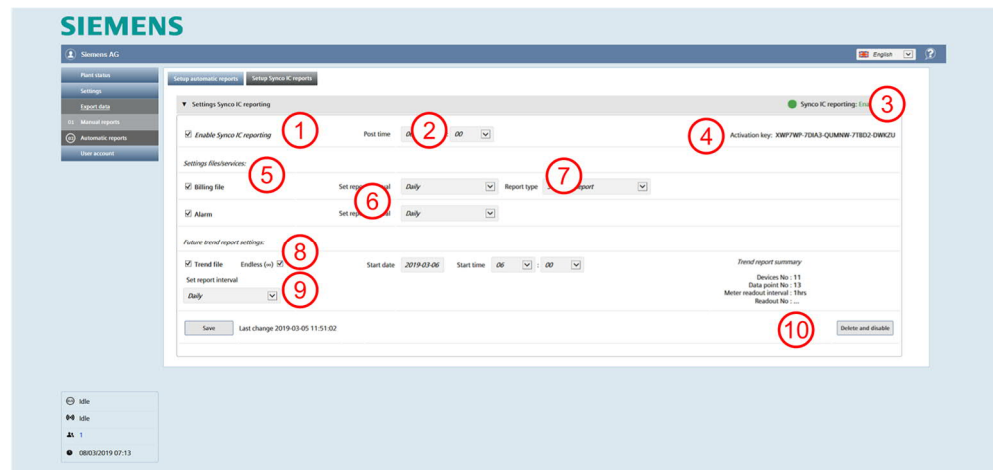

① Enable Synco IC reporting

Enable the check box "Enable Synco IC reporting", if reports are automatically transmitted effective immediately. Simply clear the check box to stop the transmission of reports at any time.

② The following options are available for setting report transmission: Post time

Select the time to send the reports (applies to all reports).



You can send the time to within 15 minutes.

Click 'Save' to save the entries

③ Status of Synco IC reporting

The status for automatic transmission of Synco IC reports changes to "enabled" when the "Enable Synco IC reports" is check box is selected. You can enable or disable the "Enable Synco IC reporting" check box at any time. The status changes to "Manually stopped" after disabling and no more reports are transmitted to Synco IC.

The status "Not enabled" displays at first log in.

④ Activation key

The activation key is required to register the web server in the Synco IC portal. Additional information on web server registration is available in Section "Web server integration in Synco IC", pg. 44.

5 Settings Files/Services

Select the check box or boxes alongside the files and services to be sent to Synco IC. You can make multiple selections.

Settings files/services:

Billing file

Alarm

The following files and services are available.

- Billing file: This file includes the consumption data and device information from devices such as wireless and wired meters and sensors.
- Alarms: Web server alarms transmitted to Synco IC. In addition, the last corresponding alarm file is saved in Synco IC. An email notification is sent per Synco IC user settings as soon as the web server detects an alarm.

The billing files and alarms are enabled by default.

Click Save to save your entries.

6 Set report interval

Select the interval for generating a report.

Set report interval

Monthly
Daily
Weekly

The following options are available:

- Daily: The report is generated daily at the present post time for the previous 24 hours.
- Weekly: The report is sent each Monday at the present post time for the last week.
- Monthly: The report is generated on the first day of the month at the present post time for the last month.

Default settings:

- Billing file: Monthly
- Alarms: Daily

Click Save to save your entries.

7 Report type

You must select the report type to generate automatic reports:

- Custom report
- Standard report
- Report "All data"

Billing file type

Custom Report
Standard Report
All Data Report

A custom report is generated by default.

Details on report types is available in Section "Creating reports", pg. 116.

Click Save to save your entries.

8 Settings Trend report – Future

A trend in the future includes an evaluation of the meter data over a timeframe set in the future.

Trend file Endless (∞)

Set report interval

Daily ▼

Select the "Trend file" check box to create a trend file in the future and set a start and end date with start and end time in the future. A trend file is sent to the Synco IC cloud as soon as the web server creates a trend over this timeframe.

The trend files and alarm reports include both meter and controller data. Trend files are cleared by default.

Note



A start and end date in the past are not permitted for trend files in the future. The number of read outs is listed in red font under "Trend file summary" if the entry is erroneous.

The number of read outs is also in red font is the selected timeframe for read outs is too large. Shorten the timeframe in this case or reduce the number of data points.

Trend file Endless (∞)

Start date 2019-03-14 Start time 07 : 30 ▼

Set report interval

Daily ▼

End date 2019-03-07 End time 01 : 00 ▼

Trend report summ.

Devices No :
Data point No :
Meter readout interval :
Readout No :

9 Report interval

As an option, you can create a monitoring report for meter data.

Set the interval at which an interim report of meter data is created.

The check box 'Endless' determines whether interim reports are created for an unspecified period or whether an overall report is created on the entered end date.

If cleared, the overall report is sent to Synco IC on the preset end date.

Daily ▼

None

Daily

Weekly

Monthly

The following settings are available:

- Daily: The report is created at the preset post time for the previous 24 hours and sent to Synco IC.
- Weekly: The trend file is sent each Monday at the preset post time for the past week and sent to Synco IC.
- Monthly: The trend file is created on the first day of each month at the present post time for the past month and sent to Synco IC.

"Daily" is the default setting.

Note



The check box 'Endless' is hidden if no report interval is selected.

The 'Save' button saves the entries. The date and time of the last save is displayed to the right of the button after saving.

10

Delete SyncoIC data incl. Disable SyncoIC reporting

For a change of web server ownership only: Click the button "Delete and Disable".

Delete SyncoIC Data incl. Disable SyncoIC reporting

Delete and Disable

Very important



Caution: The function "Delete SyncoIC data incl. Disable Synco IC reporting" irretrievably deletes all data and resets the status for "Enable Synco IC reports" to "Disabled". All Synco IC procedures must be reassigned.

Readout mobile data

Your mobile device can be comfortably read out the meter data on site and download it to your mobile device, regardless of platform.

Make sure the WLAN connection and 'Mobile' option are enabled.

Additional information on the WLAN connection is available in section 'WLAN connection', page 59.

Connect your mobile device to web server and login with your username and password.

Additional information on connecting your mobile device and logging in is available in section 'Mobile' option, page 63.

Simple view

The following view displays after logging in.



Note

The view on your mobile device is simplified. As a consequence, you are unable to run all applications; you can only download reports and read out meter data.

Note

You cannot select the report type when reading out the web server on your mobile device via WLAN. The web server sends the last report type selected in menu 'Setup automatic reports'.

Additional information on automatic reports is available in section 'Setup automatic reports', page 109.

Download report	Click 'Download report' to download meter data from the last readout as a report on your mobile device.
Read out meter data	Click 'Read and post now' to read out the data from all connected meters. The procedure may take several minutes.
Note	Select 'Disable' to disconnect the WLAN as soon as the meter data is read out or the report is downloaded.



You can forward the report per email from your mobile device to the appropriate recipient.

12.5.3 Creating reports

Reports can be sent via:

- Email
- FTP server
- Synco IC

Email

The email looks as follows:

Betreff: Consumption data Sample alley

Nachricht  FC_report_EV16444144_2018-06-05_07-43.xls (22 KB)

SIEMENS

2018-06-05 07:46:51 | WTV676-HB6035 Automatic Report

Plant name:	Sample alley
Address:	21 model street
Current IP address:	https://85.4.236.248:443
Model:	WTV676-HB6035
System clock:	2018-06-05 07:46:51
Firmware version:	2.5_1.6_2.3
Web interface version:	2.21
Serial number:	EV16444144

- Header: See settings in Section "Setup automatic reports", page 109.
- Plants: Displays the name of the read file including the web server serial number, creation date and time.
- Plant information: Displays information on the object and web server (see System Status)

The following report types are available:

- Standard report
- Individual reports
- All data report

History trend files and trend files in the future are available in addition to the reports.

Important

The web server can only read out information that was also sent by the device via an M-bus telegram. Check the corresponding telegram if information is missing in the report.

Standard report

The **Standard report** lists all read devices. A device corresponds to one line. Each column is the same for each device. The columns with the corresponding titles are preset. The field remains blank if the device does not report a value.

The columns must be assigned to the corresponding data point in the device settings.

File Name	Report Date	Report Time	Plant Reference	Firmware version	Total devices cabled	Total devices wireless	Serial Number			
FC_report_EV0000000_2016-06-16.xls	16.06.2016	10:54:06	Rehalse - Musterallee 25, 6300 Zug	1.0111_0_1_0_1_0	20	0	EV00000000			
count	primary_address	device_serial_number	name_device	device_description	device_detail	device_measure_hex	0=wireless	model_id	readout_date	readout_time
0	0	65971928	DEV_65971928	PA_000	04heat	0	0	Siemens - WFN52141	16.06.2016	10:53:28
1	0	65960399	DEV_65960399	PA_000	04Cooling	0	0	Siemens - WFN5177	16.06.2016	10:54:00
2	0	65960398	DEV_65960398	PA_000	04heat	0	0	Siemens - WFN5178	16.06.2016	10:53:28
3	0	65976340	DEV_65976340	PA_000	04Cooling	0	0	Siemens - WFN52141	16.06.2016	10:53:57
4	0	65976339	DEV_65976339	PA_000	04heat	0	0	Siemens - WFN52140	16.06.2016	10:53:22
5	0	65960050	DEV_65960050	PA_000	04heat	0	0	Siemens - WFN52114	16.06.2016	10:54:03

Note

Check the data points if a meter does not appear in the standard report.

In the menu "Settings > Wired devices" or "Wireless device", you can define in the column "Standard report – Data point mapping" the value (data point) per meter to list and under what title in the standard report. The standard report permits the setting up of a summary report using a standard format.

Main Value	User description	M-bus description	Standard Report - Data point mapping	Custom Report - Data point to be included	...
<input type="radio"/>	Time Point	Time Point	none	<input type="checkbox"/>	...
<input checked="" type="radio"/>	Energy	Energy	none device_data_time error_flag_decimal fabrication_number heat_energy cool_energy HC.A heat_water_volume cool_water_volume water_volume aux1_volume aux2_volume aux3_volume gas_volume electricity_active_energy electricity_reactive_energy	<input checked="" type="checkbox"/>	...
<input type="radio"/>	Time Point	Time Point		<input type="checkbox"/>	...
<input type="radio"/>	Energy	Energy		<input checked="" type="checkbox"/>	...
<input type="radio"/>	Time Point	Time Point		<input type="checkbox"/>	...
<input type="radio"/>	Error Flag	Error Flag		<input type="checkbox"/>	...
<input type="radio"/>	Size of Storage Block	Size of Storage Block		<input type="checkbox"/>	...
<input type="radio"/>	Time Point	Time Point		<input type="checkbox"/>	...

Custom report

A **Custom report** displays each device with two lines: The first line describes the content and the second the corresponding values. The number of columns varies by device depending on the device and selected data points. Only data points defined in Section 12.4.3 are listed.

File Name	Report Date	Report Time	Plant Reference	Firmware version	Total devices cabled	Total devices wireless	Serial Number			
CUST_report_EV0000000_2016-06-16.xls	16.06.2016	11:13:06	Rehalse - Musterallee 25, 6300 Zug	1.0111_0_1_0_1_0	20	0	EV00000000			
count	primary_address	device_serial_number	name_device	device_description	device_detail	device_measure_hex	0=wireless	model_id	readout_date	readout_time
0	0	66071928	DEV_66071928	PA_000	04heat	0	0	Siemens - WFN52141	16.06.2016	11:12:57
count	primary_address	device_serial_number	name_device	device_description	device_detail	device_measure_hex	0=wireless	model_id	readout_date	readout_time
1	0	65960399	DEV_65960399	PA_000	04Cooling	0	0	Siemens - WFN5177	16.06.2016	11:13:10
count	primary_address	device_serial_number	name_device	device_description	device_detail	device_measure_hex	0=wireless	model_id	readout_date	readout_time
2	0	65960398	DEV_65960398	PA_000	04heat	0	0	Siemens - WFN5178	16.06.2016	11:12:58
count	primary_address	device_serial_number	name_device	device_description	device_detail	device_measure_hex	0=wireless	model_id	readout_date	readout_time
3	0	65976340	DEV_65976340	PA_000	04Cooling	0	0	Siemens - WFN52141	16.06.2016	11:13:06
count	primary_address	device_serial_number	name_device	device_description	device_detail	device_measure_hex	0=wireless	model_id	readout_date	readout_time
4	0	65976339	DEV_65976339	PA_000	04heat	0	0	Siemens - WFN52140	16.06.2016	11:12:51

Note

For the **Custom report**, you can select in the column "Custom report – Data point to be included", the data points for inclusion in the report.

Main Value	User description	M-bus description	Standard Report - Data point mapping	Custom Report - Data point to be included	...
<input type="radio"/>	Time Point	Time Point	none	<input type="checkbox"/>	...
<input checked="" type="radio"/>	Energy	Energy	none	<input checked="" type="checkbox"/>	...

Report "All data"

Report all data displays each device with two lines: The first line describes the content and the second the corresponding values. The numbers of columns vary for each device depending on device type.

All data points are listed that can be read.

File Name	Report Date	Report Time	Plant Reference	Firmware version	Total devices cabled	Total devices wireless	Serial Number			
Report_report_EV0000000_2016-06-16.xlsx	16.06.2016	11:58:09	Remonte - Musterallee 28, 6900 2-00	1.0711-0_1_0_1_0	0	0	EV0000000			
count	primary_address	device_serial_number	name_device	device_description	device_detail	device_measure_hex	0=wireless	model_id	readout_date	readout_time
0	0	85071928	DEV_85071928	PA_000	043-net	0			16.06.2016	11:58:12
count	primary_address	device_serial_number	name_device	device_description	device_detail	device_measure_hex	0=wireless	model_id	readout_date	readout_time
1	0	85990399	DEV_85990399	PA_000	043-cooling	0		Siemens - WFA51177	16.06.2016	11:58:44
count	primary_address	device_serial_number	name_device	device_description	device_detail	device_measure_hex	0=wireless	model_id	readout_date	readout_time
2	0	85990398	DEV_85990398	PA_000	043-net	0		Siemens - WFA51176	16.06.2016	11:58:09
count	primary_address	device_serial_number	name_device	device_description	device_detail	device_measure_hex	0=wireless	model_id	readout_date	readout_time
3	0	85976340	DEV_85976340	PA_000	043-cooling	0		Siemens - WFA532141	16.06.2016	11:58:41

Note



The numbers in the reports are depicted as follows:

- Period as a decimal point separator.

Trend file

In principle, there are two types of trends: History trends and trends in the future.

A **history trend file** includes an evaluation of meter data in the past.

You can evaluate meter data in the past at any time. The data remains on the web server and is not sent to Synco IC.

In menu "Manual reports", select report type "Trend file" and set a start and end date. Finish by clicking "Create report".

Additional information on manual reports is available in Section "Manual reports", pg. 107.

A **trend file in the future** includes an evaluation of meter data over a timeframe in the future.

You can set a timeframe in the future at any time to read the meter data. The web server generates a web server once the timeframe expires and sends the file to Synco IC.

To generate a trend file in the future, enter a start and end date with time in the future in the "Automatic reports" menu.

Additional information on automatic reports is available in Section "Setup automatic reports", pg. 109.

Information on Synco IC is available in document A6V10500249, see Section Reference documents, pg. 7.

Note



A history or future trend file is created one time.

To create a new trend file in the future, select "Trend file" and set a new timeframe in the future.

History trend files are generated with "Create report" and are available immediately.

The trend data is saved to an Excel worksheet.

A trend file is set up as follows:

Report Date	Report Time	Plant Reference	Firmware version	Total devices cabled	Total devices wireless	Serial Number	File Name
29.08.2018	11:32:08	Sample alley	2.23 2.7_1.7_2.4	1	1	EV16444187	TREND_report_EV16444187_2018-08-29_2018-08-29.csv
Query interval	15min						
Beginning	00:00:00	29.08.2018					
End	23:45:00	29.08.2018					
Fabr. No	[35026219]	[00071725]					
Log Interval	1hrs	15min					
Data point							
	Total volume (m3)	Volume (m3)					
2018-Aug-29 00:00		7.098					
2018-Aug-29 00:15		7.098					
2018-Aug-29 00:30		7.098					
2018-Aug-29 00:45		7.098					
2018-Aug-29 01:00	5.386	7.098					
2018-Aug-29 01:15		7.098					
2018-Aug-29 01:30		7.098					
2018-Aug-29 01:45		7.098					
2018-Aug-29 02:00	5.386	7.098					
2018-Aug-29 02:15		7.098					
2018-Aug-29 02:30		7.098					
2018-Aug-29 02:45		7.098					
2018-Aug-29 03:00	5.386	7.098					

1 Plant data

This area displays the creation date of the trend file with time as well as plant data and the number of connected devices.

2 Timeframe

This area indicates the query interval as well as the timeframe for reading out meter data. The query interval displayed here corresponds to the shortest query interval that was set for a device in this trend file. Additional information on query intervals is available below in this section.

3 Meter readout data

This area summarizes the meter information by column. This includes the device ID (fabrication number), readout interval, and read out data point. Additional information on query intervals is available below in this section.

4 Date / time

The data and time are indicated in the first two columns. The data and time of the readout with the corresponding meter data is displayed per line. The time intervals correspond to the shortest query interval that was set for a device. Additional information on query intervals is available below in this section.

5 Meter data

This area displays the values of read out data point per meter. A column corresponds to a meter.

The meter can also be depicted graphically in a diagram, in addition to display in tables. Use the diagram function in Excel.

Query interval

An individual query interval can be defined for each device. The interval determines the time span for reading out the device. The shortest query interval applies to the time span in the trend file if individual, connected devices have different query intervals. For example, a value for the device is only entered in the trend file every seven days if a query interval of seven days is set for the device.

The query interval can be set in the device settings, see Section "Wired devices, pg. 89 and "Wireless devices", pg. 100.

12.6 User account

The User account menu displays all registered users and creates a new user. Moreover, all login attempts are registered (logbook).

Click **Exit** to log off web server.

12.6.1 User configuration

New user

The **New user** creates a new user account on web server.

At the same time, it provides information on all previously registered users, including access rights (user type).

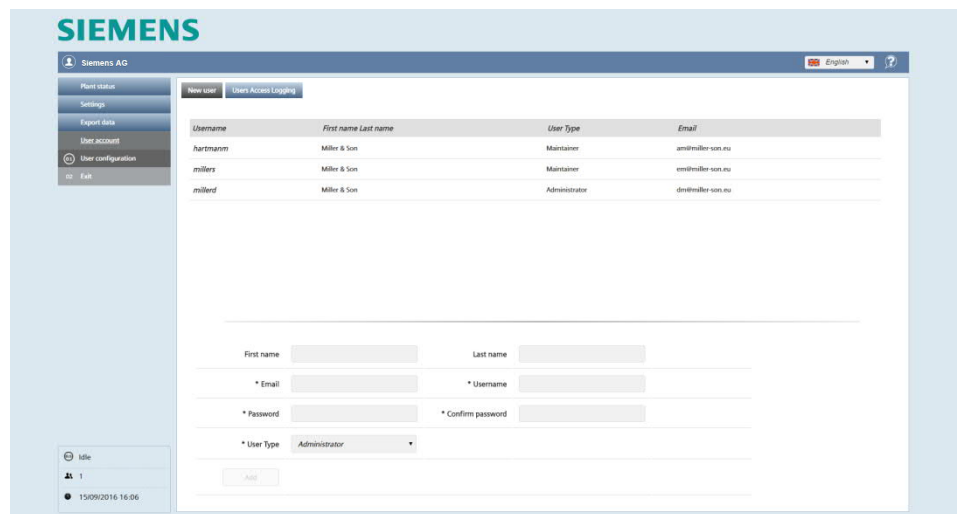

You must be logged in as an administrator to change user data or create a new user.

Form fields for adding a new user:

- First name:
- Last name:
- * Email:
- * Username:
- * Password:
- * Confirm password:
- * User Type:

Add

Enter the new user data and click **Add**:

- First name
- Last name
- Email
- Username
- Password including confirm password
- User type
 - User: Users have a restricted view on web server and cannot change or enter settings.
 - Maintainer: Maintainers have a restricted view on web server. They can change or enter some settings compared to users.
 - Administrator: Administrators have access to all data and functions.

Menu	Administrator	Maintainer	User
Plant state	U	R	R
Settings	U	R	-
Export data	U	U	U
User account	U	-	-

U = Unrestricted access

R = Restricted access

- = no access

Users access logging

All login actions are registered on web server.

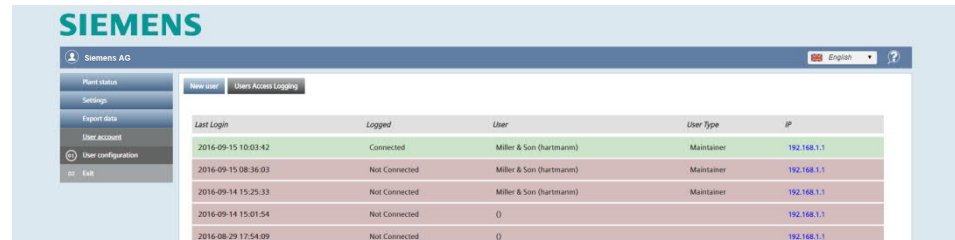

Last Login	Logged	User	User Type	IP
2016-09-15 10:03:42	Connected	Miller & Son (hartmann)	Maintainer	192.168.1.1
2016-09-15 08:36:03	Not Connected	Miller & Son (hartmann)	Maintainer	192.168.1.1
2016-09-14 15:25:33	Not Connected	Miller & Son (hartmann)	Maintainer	192.168.1.1
2016-09-14 15:01:54	Not Connected	()		192.168.1.1
2016-08-29 17:54:09	Not Connected	()		192.168.1.1

The following information is retained for each login:

- Last login: Date & time the user logged in.
- Logged: User status.
- User: First and last name of the user
- User type: Administrator / Maintainer / User
- IP address: IP address of the PC used by the user to access web server

User access data is registered for the last 28 days.

12.6.2 Log off

Click **Exit** to log off web server without further warning.

13 Appendix

13.1 Router configuration

13.1.1 Port forwarding

Web server uses the following port:

- 443 (fixed port for HTTPS protocol)

To access the web server from the Internet, you must setup a port forwarding rule in the router to the IP address and port 443 of the web server. The external port number can be defined freely but has to be unique within the router.

The chosen external port number must also to be entered in the LAN settings, page 85.

13.2 Open Source Software

Open Source Software (OSS) is used on web server.

License information

The license texts of all Open Source Software packages can be viewed individually at 

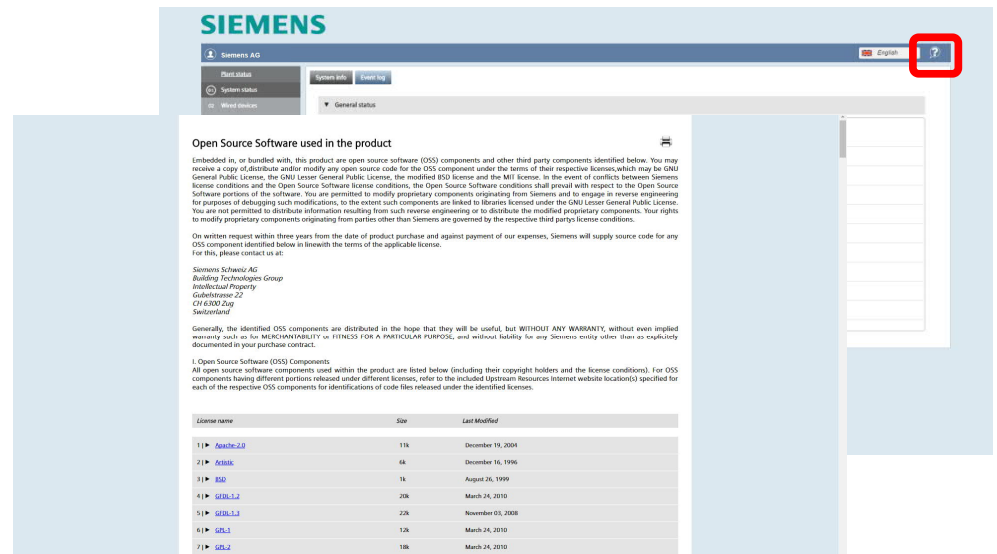

The screenshot shows the Siemens web server interface. At the top, there is a navigation bar with 'Siemens AG' on the left and 'English' and a help icon (a question mark in a square) on the right. Below the navigation bar, there are several tabs: 'Plant status', 'System status', and 'Web services'. The 'System status' tab is selected, and under it, 'General status' is expanded. The main content area is titled 'Open Source Software used in the product'. It contains a detailed text block explaining the OSS components and their licenses, followed by a table listing the components.

License name	Size	Last Modified
1 ▶ Apache 2.0	11k	December 19, 2004
2 ▶ Astisk	4k	December 16, 1996
3 ▶ BSD	1k	August 26, 1989
4 ▶ GDB-7.2	20k	March 24, 2010
5 ▶ GDB-7.3	22k	November 03, 2008
6 ▶ GPL-1	12k	March 24, 2010
7 ▶ GPL-2	10k	March 24, 2010

Tools for packages upgrading

All packages subject to a GPL-3 or LGPL-3 license must be made upgradable to experienced users for legal licensing reasons.
The packages are labeled on the list with .

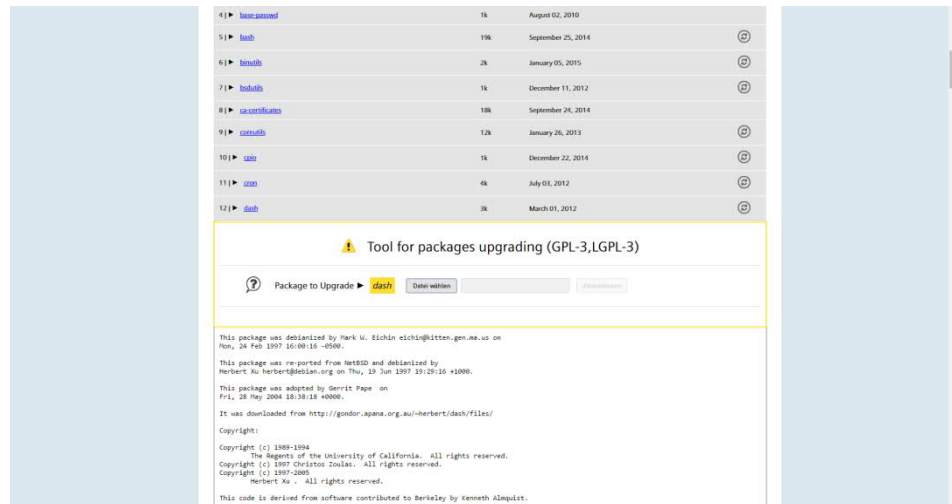

Siemens regularly provides firmware updates to the web server. This occurs exclusively through firmware updates (online or offline). The tool for package upgrades is not required to operate and maintain the web server. The current firmware includes the latest features and web server functions.

Preparing the firmware update

Connect the web server to a PC before installing the new firmware. For additional information on connecting web server to the PC, see Section 'Connect web server to PC or LAN', page 39.

Back up the data for you web server.

For additional information on backing up data, see Section 'Backup/restore', page 84.

Update the firmware online or offline.

For additional information on updating firmware, see Sections 'Update firmware online' and 'Update firmware offline'.

Important



Caution: Web server can no longer be used as the M-bus master as soon as a package is changed with this tool! Access to web server over web operation and local operation is no longer possible! All data is deleted on the web server for security reasons! This procedure can no longer be rescinded and a new web server must be purchased if the tool is accidentally used to update a package! Only the Linux base system remains on the device after completing a package update.

The device can then be accessed via an SSH connection through Ethernet port 192.168.1.110. Use username **root** and password **12345678**.

14 Technical data

The technical data for the level converter and web server is available in the appropriate datasheets:

M-bus level converter	WTV531-GA5060	A6V10844290
M-bus level converter	WTV631-GA0090	A6V11742346
M-bus web server	WTV676-HB6035	A6V11157961
RF converter	WTV660-E05060	A6V10455680

15 Revision numbers

Product no.	Valid from rev. no.
WTX660-E05060	..A

A		Settings	96
Access code.....	41	Device alarm settings	93
Change	49	Device information.....	70
Entry	49	Device list	90, 93, 94, 101
Reset	50, 81	Device name	91, 95, 102
Access to Web server.....	40	Device search	97
Acronyms	8	Channel ID.....	105
ACT531.....	18, 28, 30, 34, 36	M-bus radio network.....	104
Activation key	44, 112	Mesh ID.....	105
Addressing M-bus.....	25	Device settings.....	91, 95, 101
Alarm settings device.....	93, 103	Device version.....	91, 96
Alarms.....	80	Devices alarm settings	103
Automatic reports	109	DHCP	85
		Digital inputs web server	31
B		Digital outputs	32
Backup.....	81	DIN rails	13
Backup file.....	74	DNS	85
Basic settings	42	Dynamic DNS	88
Baud rate	91, 96, 99		
Bus expansion.....	26	E	
		Email.....	117
C		Email configuration.....	87
Cable types M-bus.....	25	Email notification in the Synco IC	
Commisioning		portal	33
RF converter	37	Enable web server in Synco IC.....	33
Commissioning M-bus	41	Encryption.....	102
Configure Synco IC reports.....	32	Ethernet	39
Connection		Event log.....	67
Devices to level converter	30	Events.....	106
Devices to web server	30	Events inputs/outputs	106
External component	32	Exit.....	122
Level converter Master / Slave ..	27	Export data.....	107
Level converter to PC.....	28		
Potential-free contacts.....	31	F	
RF converter to PC	30	Faults	
Web server to LAN/PC	29	Level converter	36
Web server to level converter	27	Web server	43
Web server to PC/LAN	39	Firmware	
Connection terminals		Level converter	36
Level converter	13	Web server	81
Level converter WTX631	14	First access.....	61
Web server.....	15	FTP server report send.....	110
Contacts web server.....	31		
Copyright.....	8	G	
Create report.....	107	Gateway.....	85
Current level converter	24		
		I	
D		Inputs web server.....	31, 106
Data point settings.....	91, 102	Inputs/outputs web server.....	78
Data points		IP address.....	40

L		O	
LAN.....	39	Open Source Software	123
Language setting.....	48, 58	Operating modes	
LED.....	13, 15, 34	Level converter	18
Level converter.....	28	Operation	
Connection to web server.....	27	Level converter WTV531.....	45
Connections.....	13	Level converter WTX631.....	45
Displays.....	34	RF converter.....	46
Faults.....	36	Web server	61
Firmware.....	36	Operation modes	
Indicators	34	Web server with RF converter	21
Operating modes	18	Outputs web server	32, 106
Operating state	34		
Operating WTX631	45	P	
Power supply	24	Password conditions	62
License information	123	Plant data.....	79
Log off.....	122	Plant status.....	65
Logging		Port forwarding.....	123
Events.....	67	Potential-free contacts web server.	31
Users access	122	Power supply	
Login	62	Level converter	24
		Primary addresses	25
M		R	
MAC.....	85	Radio mode.....	102
Main menu web server	51	Readout data	
Maintenance.....	81	Mobile readout	23
Manual reports	107	Readout of data	
Manufacturer	91, 96, 102	Readout via PC / Internet browser	
Master.....	18, 20	23
M-bus		Registration.....	61
Addressing.....	25	Relays web server.....	32
Bus expansion	26	Report interval.....	109
Cable types.....	25	Report types.....	117
Topology		Reports	116
Wireless devices.....	17	Set up.....	109
Topology wired.....	16	To FTP server	110
Wired	11	Restore	81
Wireless.....	11	RF converter	30
M-bus devices		Change mesh ID.....	47
Wired	16	Commissioning	37
Wireless.....	17	Functions.....	10
Menu		Router configuration	123
Main menu.....	51		
Settings.....	57	S	
System info.....	53	Scan interval	91
Wired search.....	56	Scheduler.....	77
Mesh RF protocol.....	21	Secondary addresses.....	25
Meter list	89, 100	Set up device	93
Meter search	97	Set up meter	89, 100
Mobile option.....	63	Sign in.....	62
Mounting	13	Slave.....	19
		System clock.....	81
N		System extension.....	19, 21, 27
Network settings.....	85	System restart.....	81
		System status	65

T

Third-party products	9
Topology.....	16
Trend file	
Historical trend file.....	117
Trend file - future.....	117
Troubleshooting	
Level converter	36
Web server.....	43

U

User account	
Reset	50
User accounts	121
Users access logging.....	122

W

Web server.....	21, 27
Access.....	40
Buttons	48
Connection	15
Display.....	49
Faults.....	43
Firmware	81
Functions.....	10
Operation.....	61
Settings menu.....	57
System info menu	53
Wired search menu.....	56
Wired devices	69
Wired search.....	56
WLAN connection.....	59
WTV remote access	40

Published by:
Siemens Switzerland Ltd.
Smart Infrastructure
Global Headquarters
Theilerstrasse 1a
CH-6300 Zug
Switzerland
Tel. +41 58-724 24 24
www.siemens.com/buildingtechnologies

© Siemens Switzerland Ltd, 2017
Subject to change