

SIEMENS



G120P

Variable Speed Drive

Technical Manual

Imprint

Technical specifications and availability subject to change without notice.

Transmittal, reproduction, dissemination and/or editing of this document as well as utilization of its contents and communication thereof to others without express authorization are prohibited. Offenders will be held liable for payment of damages. All rights created by patent grant or registration of a utility model or design patent are reserved.

Issued by:

Siemens Switzerland Ltd
Smart Infrastructure
Global Headquarters
Theilerstrasse 1a
CH-6300 Zug
Switzerland

Tel. +41 58 724-24 24

www.siemens.com/buildingtechnologies

Edition: 2021-10-11

Document ID: A5E36496664A_f

© Siemens Switzerland Ltd, 2021

Table of contents

1	History of changes	5
2	About this documentation.....	6
2.1	Purpose of this documentation.....	6
2.2	Reference sources for documents	8
2.3	Product documentation.....	9
3	Safety	10
3.1	Intended use	10
3.2	Safety equipment.....	11
3.3	Personnel requirements.....	12
3.4	Responsibilities of the operating personnel.....	12
3.5	Residual risks	13
3.5.1	Voltage hazards.....	13
3.5.2	Dangers posed by moving parts	14
3.5.3	Dangers due to fire and explosion	15
3.5.4	Dangers due to electromagnetic fields	16
3.5.5	Dangers due to parameterization errors.....	16
3.5.6	Dangers due to inactive safety functions.....	17
3.5.7	Dangers due to unsuitable site of installation.....	17
3.6	Handling electrostatic discharge sensitive devices.....	18
3.7	Disclaimer of liability.....	18
4	Product information.....	19
4.1	Product description.....	19
4.2	Components.....	21
4.2.1	CU230P-2-BT Control Unit.....	22
4.2.2	PM230 Power Module.....	24
4.2.3	Operator panels.....	25
4.3	License terms	30
5	Installing	31
5.1	Safety instructions for installation.....	31
5.2	Overview of installation	32
5.3	Installing the Power Module	33
5.3.1	Installing Power Modules.....	33
5.3.2	Connecting line and motor terminals	34
5.4	Installing the Control Unit.....	43
5.4.1	Installing the Control Unit.....	43
5.4.2	Wiring terminal strips.....	45
5.5	Installing the operator panel	47
5.6	EMC-compliant installation (examples)	48
6	Commissioning.....	54
6.1	Safety instructions for commissioning	54
6.2	Overview of the commissioning.....	54
6.3	Preparing for commissioning	55

6.4	Carrying out basic commissioning.....	55
6.5	Configuring communication	70
6.6	Additional settings.....	74
6.6.1	Restoring parameters to factory settings	74
6.6.2	Setting the PID controller	76
6.6.3	Overview of parameters.....	77
6.7	Backing up data (memory card).....	81
7	Application examples.....	82
7.1	Factory settings.....	82
7.2	Universal application	82
7.3	Pump pressure control	84
7.4	Pressure controlled supply fan + ESM fixed speed	85
7.5	Cooling tower fan (LG-Ni1000) + hibernation.....	86
7.6	Cooling tower fan (active sensor) + hibernation	87
7.7	Stairwell pressurization (ESM).....	88
7.8	Fixed setpoints.....	89
7.9	CO2 sensor, 2 PID setpoints	90
7.10	Temperature-dependent pressure setpoint	91
7.11	Fan with belt monitoring function.....	92
7.12	Pressure-controlled pump with cascade	93
7.13	Fans in 87 Hz operation	94
8	Service, maintenance and fault rectification	95
8.1	Safety guidelines for service, maintenance and fault rectification	95
8.2	Service and maintenance.....	95
8.2.1	Maintenance schedule	95
8.2.2	Fan maintenance.....	96
8.3	Fault rectification.....	96
8.3.1	Displayed operating states.....	96
8.3.2	Fault table (SW).....	97
8.3.3	Hardware diagnostics (HW).....	103
9	Technical data.....	111
9.1	Functional data	111
9.2	Conformity.....	114
10	Appendix Commissioning report.....	115

1 History of changes

The table below shows this document's history of changes:

Version	Edition date	Brief description
f	2021-10-11	Complete revision and introduction IOP-2-BT
e	2017-01-24	Neutral concerning FW and version of related documentation
d	2016-03-18	FW4.7 SP6 HF1
c	2015-01-06	FW4.7 SP3
b	2014-05-16	FW4.7
a	2013-03-19	First edition, FW4.6

2 About this documentation

2.1 Purpose of this documentation

This Operating Manual provides a summary of all of the information required to operate the SINAMICS G120P variable speed drive (referred to below as "variable speed drive" or "device") under regular, safe conditions. For further information, that is, all other relevant documentation, please refer to Chapter Product documentation [→ 8].

This Operating Manual describes the devices and device components and provide persons belonging to the target groups defined below with the information they need to correctly and safely install, assemble, connect, adjust, commission, maintain and troubleshoot SINAMICS G120P variable speed drives.

Target groups

The information in this document is aimed at the following target groups:

Target group	Activity	Qualification
Qualified electrician	<ul style="list-style-type: none"> Responsible for installation, commissioning, maintenance and diagnosis. 	<ul style="list-style-type: none"> Qualified personnel are those who, based on their training and experience, are capable of identifying risks and avoiding potential hazards when working with these products/systems.

Typographical conventions

Date format

The date format recommended in the international standard ISO 8601 (format YYYY-MM-DD) has been used in this document.



Text markups

Special text markups are displayed as follows in this document:



▷	Requirement for a procedural instruction
1. 2.	Procedural instruction involving at least two operations
–	Variant, option or detailed information relating to a procedural instruction
⇒	Interim result of a procedural instruction
⇒	Final result of a procedural instruction
•	Lists and procedural instructions involving one operation
[→ X]	Reference to a page number
'Text'	Quote, exact match
<Key>	Names of keys

Examples of how safety instructions are displayed in this document



Example of a danger notice for hazardous voltages, which, if ignored, will result in death or serious injuries.

	 DANGER
	<p>Type and source of the danger Consequences of failing to heed the danger</p> <ul style="list-style-type: none"> Measures to avoid the danger

Example of a danger notice for moving parts, which, if ignored, may result in death or serious injuries.

	 WARNING
	<p>Type and source of the danger Consequences of failing to heed the danger</p> <ul style="list-style-type: none"> Measures to avoid the danger

Example of a general danger notice, which, if ignored, may result in minor or slight injuries.

	 CAUTION
	<p>Type and source of the danger Consequences of failing to heed the danger</p> <ul style="list-style-type: none"> Measures to avoid the danger

Example of a note, which, if ignored, may result in damage to the plant or to the area around it.

	NOTICE
	<p>Important note Consequences of failing to heed the note</p> <ul style="list-style-type: none"> Measures to avoid the danger

Example of an informative note, which, if not heeded, does not entail any danger.



Supplementary information/tips that make it easier for the user to handle the product.

2.2 Reference sources for documents

Siemens Industry Online Support (SIOS)

Various document types, such as data sheets, operating instructions, assembly instructions and license texts can be found in the SIOS portal (Siemens Industry Online Support) at <https://support.industry.siemens.com>.

If required, a user account can be created here first.

The individual entries for documents, announcements, technical articles, etc. can be accessed by means of the SIOS entry ID, which is entered in the search window. For example, the entry for the IOP-2-BT manual can be reached with the entry ID [109781592](#). Entering the document number (e.g. A5E34257946B) in the search window will list all matching entries.

Further Online Sources

Information about the G120P product range and references to documents and tools can also be found at the following Internet address:

<http://siemens.com/G120P>

The commissioning software "STARTER" can be downloaded from the address

<http://www.siemens.com/starter>.

Industry Online Support as Smartphone App



The main functions of the SIOS portal with useful tools such as a Hz-U/min converter or support for spare parts ordering (SoW - Spares On Web) are available in the Industry Online Support App, which supports direct barcode scanning.

Smartphone App "Industry online support":



Figure 1: iTunes



Figure 2: Google Store

2.3 Product documentation

Title	Description	Source/Document ID
Operating Manual	Design, installation, commissioning and troubleshooting the SINAMICS G120P.	A5E36496664A
Hardware Installation Manual Power Module PM230 Hardware IP55	Guide with all the information needed to install, mount, connect, and service SINAMICS G120P systems.	A5E35319202B
Hardware Installation Manual Power Module PM230 Hardware IP20	Guide with all the information needed to install, mount, connect, and service SINAMICS G120P systems.	A5E34331322B
Operating Instructions Basic Operator Panel	Basic Operator Panel 2 (BOP-2)	A5E37143404B
Operating Instructions Intelligent Operator Panel	Intelligent Operator Panel 2 (IOP-2 / IOP-2-BT)	A5E39549448B
Operating Instructions Webserver-Modul	SINAMICS G120 Smart Access	A5E43332549
Application examples	See link for application examples and information on use of variable speed drives	http://support.automation.siemens.com/WW/view/en/20208582/136000
General product information	See link for detailed information and support tools for variable speed drives.	http://www.siemens.com/g120p
Operating Instructions Control Unit	Guide for installation engineers, commissioners, and operators on Control Unit CU230P-2.	A5E34257946B
Function Manual, Fieldbus systems	Instructions for operation when connected to a fieldbus system.	A5E34229197B
List Manual Control Unit	Manual with list information including parameters and error codes.	A5E33838102
Desigo	Information on commissioning and integrating into Desigo systems including parameter settings.	CM110576
PICS	SINAMICS BACnet Protocol Implementation Conformance Statement.	CM2Y5111
Data sheet: Supplementary system components	Data sheet with general information on the operator panels IOP-2-BT, BOP-2, the webserver module SAM and the blanking cover.	CM1N5116en
SINAMICS G120P operation in the event of a fire	Use of Essential Service Mode (ESM).	SIOS Entry-ID 63969509
Bundle Sheet	Installation Instructions FSA...FSF	A5E32294594B
Line Filters	Installation Instructions FSA...FSC	A5E03879697B
Line Filters	Installation Instructions FSD...FSF	A5E31327192B

3 Safety

General warnings, precautionary measures and hazard instructions which apply when working with the device are summarized below. Safety information which only applies to certain tasks is listed at the start of every section or is repeated or added at critical points within these sections.

3.1 Intended use

The SINAMICS G120P variable speed drive described in these Operating Instructions is a device for controlling an induction motor. The variable speed drive is designed for installation in electrical installations or machines.

The technical specifications and information about connection conditions are indicated on the rating plate (Chapter Technical data [→ 111]).

"Intended use" also includes compliance with all instructions contained in this document.

Use for any purpose other than the strict definition of the application contained within this document is defined as misuse.



⚠ WARNING

Dangers of misuse!

Misuse of the SINAMICS G120P variable speed drive can result in serious injury, death or damage to property.

- Do not carry out any modifications to the device.
- Do not use the device for any applications other than those described in the catalog and other relevant documentation.
- Only use spare parts and accessories which are distributed or recommended by the manufacturer of the device.
- Never use the device in operating environments which do not meet the specified ambient conditions (Chapter Technical data [→ 111]).
- Never install or operate the device in environments in which potentially explosive atmospheres can develop.
- Do not use the device as an "emergency stop device" (see EN 60204, 9.2.5.4).

3.2 Safety equipment



▲ WARNING

Danger to life due to safety equipment malfunctions!

If safety equipment fails to function properly or is deactivated or disabled, the device can pose a risk of extremely serious injury or death.

Failure to provide a proper protective conductor connection can affect the ability of protective equipment to function correctly.

- Ground the device in compliance with the applicable regulations.
- The variable speed drive can cause a DC current in the PE conductor. At locations at which a residual-current device (RCD) or a residual current monitor (RCM) is installed in order to protect against direct or indirect contact, the RCDs or RCMs on the supply side of the variable speed drive must all be type B super-resistant devices.

The following safety equipment is installed as standard:

- Overcurrent protection device

The following safety devices can be optionally provided (depending on the application) by the machine manufacturer/operator:

- Residual current devices
- Residual current monitor
- Maintenance switch which either de-energizes the variable speed drive or interrupts the connection between the variable speed drive and the motor (motor cable).

3.3 Personnel requirements

All personnel must be persons who can reasonably be expected to work reliably and conscientiously. Persons whose ability to react is impaired, for example, by drugs, alcohol or medication, are prohibited from working with the device.

The regulations pertaining to age and occupation applicable at the site of installation must be observed in the selection of personnel.



⚠ WARNING

The device may only be installed, commissioned, and maintained by trained personnel.

Many dangers, some potentially fatal, are posed by permitting unqualified personnel to work on the device. They may also result in damage to the device and to the plant.

- ▷ Qualified personnel are specialists who possess the skills required to install, mount, commission, operate, and repair the device. These people must have the following qualifications:
 - They must have received training and be authorized to switch the variable speed drive on and off, to ground the device in accordance with safety standards and to tag the circuits. They are generally people with expertise in the area of electrical installation or people who work under the supervision of experts, such as qualified electricians.
 - They have to be familiar with all the safety information, installation and operating instructions contained in this Guide and be trained to perform first aid.

3.4 Responsibilities of the operating personnel

The variable speed drive is deployed in the commercial/industrial sector. The operator of the device is therefore subject to the statutory obligations for occupational health and safety.

In addition to complying with the safety instructions contained in this document, the operator must also conform to the safety, accident prevention and environmental protection regulations applicable at the site of installation of the device. The following conditions in particular apply:

- The operator must become fully acquainted with the relevant occupational safety regulations and carry out a risk assessment to determine additional hazards which may arise as a result of the specific working conditions at the site of installation.
- When assessing the machine's risk in accordance with the respective local regulations (e.g., EC Machinery Directive), the operator (or machine manufacturer) must take into account the following residual risks emanating from the control and drive components of a drive system.
- The operator (or machine manufacturer) must install additional safety equipment so as to ensure safe operation of the device and the connected machine.
- The operator must ensure that the area in which the device is installed and operates is safe. This means that appropriate safety precautions must be taken and that notices warning of potential hazards must be clearly displayed. It is particularly important to warn of the potential hazards arising from electromagnetic fields, and to prohibit the use of mobile telephones.

3.5 Residual risks

A description is given below of the residual risks potentially posed by variable speed drives even when they are used for their intended purpose.

Please observe the safety information provided below and safety guidance contained in other sections of these Operating Instructions in order to reduce the risk to personnel and property and prevent potentially hazardous situations.

3.5.1 Voltage hazards

	<p>⚠ DANGER</p> <p>Danger to life due to live parts and components!</p> <p>The capacitors and the line and motor terminals may conduct hazardous voltages even when the device is not in service and is disconnected from the line.</p> <p>Electric shocks and short-circuits may occur if personnel come into contact with live parts, spill liquids on them or touch them with objects.</p> <ul style="list-style-type: none"> • Only work on electrical devices when you are qualified for this job. • Avoid any contact with live parts, spilling liquids on them or touching them with objects. • After switching off the power supply, wait at least 5 minutes before opening the device. • Take additional external measures if there is a risk of short-circuits; for example, independent limit switches or mechanical interlocks, etc. • De-energize the connected machine: <ul style="list-style-type: none"> - Switch off the machine. - Wait until the discharge period stated on the warning notices has elapsed. - Check that it really is in a no-voltage condition, from phase conductor to phase conductor and phase conductor to protective conductor. - Check whether the existing auxiliary supply circuits are de-energized. - Make sure that motors cannot move. • Isolate or neutralize all hazardous energy sources, e.g. by closing switches, grounding or short-circuiting. • Secure the energy sources against switching on again.
---	---

	<p>⚠ DANGER</p> <p>Danger to life due to hazardous voltages when an unsuitable power supply is connected!</p> <p>Touching live components can cause electric shock and short circuit.</p> <ul style="list-style-type: none"> • Only use power supplies that provide SELV (Safety Extra Low Voltage) or PELV (Protective Extra Low Voltage) output voltages for all connections and terminals of the electronics modules.
---	---

	⚠ DANGER
	<p>Danger to life when live parts on damaged devices are touched!</p> <p>Improper handling of devices can cause damage.</p> <ul style="list-style-type: none"> • Ensure compliance with the limit values specified in the technical data during transport, storage and operation. • Do not use any damaged devices.

	⚠ DANGER
	<p>Danger to life due to electric shock when device is not grounded!</p> <p>For missing or incorrectly implemented protective conductor connection for devices with protection class I, high voltages can be present at open, exposed parts, which when touched, can result in death or severe injury.</p> <ul style="list-style-type: none"> • Ground the device in compliance with the applicable regulations.

	⚠ DANGER
	<p>Danger to life due to electric shock when opening plug connections in operation!</p> <p>When opening plug connections in operation, arcs can result in severe injury or death.</p> <ul style="list-style-type: none"> • Only open plug connections when the equipment is in a no-voltage state, unless it has been explicitly stated that they can be opened in operation.

3.5.2 Dangers posed by moving parts

	⚠ DANGER
	<p>Danger to life due to unexpected movement of machines when using mobile wireless devices or mobile phones!</p> <p>Using mobile radios or mobile phones with a transmit power > 1 W closer than approx. 2 m to the components may cause the devices to malfunction in such a way as to influence the functional safety of machines and therefore place people at risk or cause property damage.</p> <ul style="list-style-type: none"> • Switch off radio units and mobile phones in the direct vicinity of the components.

	<p>⚠ WARNING</p>
	<p>Danger to life due to moving (rotating) mechanical parts!</p> <p>When the variable speed drive is switched on, the motor may start up unexpectedly. Contact with moving parts can cause severe physical injuries and serious property damage.</p> <ul style="list-style-type: none"> • Only touch these parts when the machine is at a standstill. • Certain parameter settings can cause the variable speed drive to restart automatically after a fault or after a failure in the power supply once the fault is eliminated and acknowledged or after the power supply is restored. • Ensure that the DIP switches are correctly set, and that the inputs are properly configured. Otherwise, the drive can start inadvertently. • Install a mechanical disconnecter (depending on the application) that allows the motor feeder cable of the variable speed drive to be disconnected for maintenance or troubleshooting.

3.5.3 Dangers due to fire and explosion

	<p>⚠ DANGER</p>
	<p>Danger to life due to spread of fire caused by use of housings that do not meet the required standards!</p> <p>Fire and smoke can cause severe personal injury or property damage.</p> <ul style="list-style-type: none"> • Install devices without a protective housing in a metal control cabinet (or provide equivalent protection for the device) in such a way that contact with fire is prevented. • Ensure that smoke can only escape via controlled and monitored paths.

	<p>⚠ DANGER</p>
	<p>Danger to life due to the motor catching fire in the event of insulation overload!</p> <p>There is a greater load on the motor insulation through a ground fault in an IT system. If the insulation fails, it is possible that death or severe injury can occur as a result of smoke and fire.</p> <ul style="list-style-type: none"> • Use a monitoring device that signals an insulation fault. • Correct the fault as quickly as possible so the motor insulation is not overloaded.

	⚠ WARNING
	<p>Danger to life due to fire if overheating occurs because of insufficient ventilation clearances!</p> <p>Insufficient ventilation clearances can result in overheating with danger to persons as a result of smoke and fire. This can also result in increased downtime and reduced service lives for devices and systems.</p> <ul style="list-style-type: none"> • Ensure compliance with the specified minimum clearances as ventilation clearances for the relevant components. These are specified in the Operating Instructions for the Control Unit (A5E34257946B).

	⚠ WARNING
	<p>Risk of explosion as a result of ignition of a potentially explosive atmosphere!</p> <p>The device is not approved for operation in areas with potentially explosive atmospheres. If it comes into contact with a potentially explosive atmosphere, the device could ignite the atmosphere and cause an explosion.</p> <ul style="list-style-type: none"> • Never install or operate the device in environments in which potentially explosive atmospheres can develop.

3.5.4 Dangers due to electromagnetic fields

	⚠ WARNING
	<p>Danger to life due to electromagnetic fields!</p> <p>Variable speed drives generate electromagnetic fields (EMF) in operation. People with pacemakers or implants are at particular risk in the immediate vicinity of these devices/systems.</p> <ul style="list-style-type: none"> • If you have a heart pacemaker or implant, maintain a minimum distance of 2 m. • Display an appropriate warning symbol in the area around the variable speed drive.

3.5.5 Dangers due to parameterization errors

	⚠ DANGER
	<p>Danger to life due to machine malfunctions caused by incorrect or changed parameter settings!</p> <p>Machines can malfunction as a result of incorrect or changed parameter assignment, which in turn can lead to injuries or death.</p> <ul style="list-style-type: none"> • Protect the parameterization (parameter settings) against unauthorized access. • Respond to possible malfunctions by applying suitable measures (e.g. EMERGENCY STOP or EMERGENCY OFF).

3.5.6 Dangers due to inactive safety functions

	<p>⚠ DANGER</p>
	<p>Danger to life due to inactive safety functions! Inactive or non-adapted safety functions can trigger machine malfunctions that cause serious injury or death.</p> <ul style="list-style-type: none"> • Install the device as instructed in this document. • Carry out a safety assessment of all safety-relevant functions of the entire system, including all safety-related components. • Make sure that parameters are appropriately set to ensure that the safety functions used in your drives and automation tasks are properly adjusted and activated. • Run a function test. • Only put your plant into live operation once you have ensured that the functions relevant to safety are running correctly.

3.5.7 Dangers due to unsuitable site of installation

<p>!</p>	<p>NOTICE</p>
	<p>Danger of property damage due to unsuitable site of installation! Unsuitable ambient conditions can damage the device by impairing its ability to function properly.</p> <ul style="list-style-type: none"> • Only install the variable speed drive in areas which are free from jolts, vibrations, electromagnetic fields, and corrosive gases. • Maintain the ambient conditions which are specified in the technical data, such as temperature, pressure, humidity, etc. (Chapter Technical data [→ 111]). • Ensure that the correct level of ventilation and air flow is provided. • IP20 devices may only be operated in closed housings or in higher-level control cabinets with protective covers that are closed, and when all of the protective devices are used.

3.6 Handling electrostatic discharge sensitive devices

Electrostatic sensitive devices (ESD) are individual components, integrated circuits, modules, or devices that may be damaged by either electrostatic fields or electrostatic discharges.

!	NOTICE
	<p>Danger of property damage due to electrical fields or electrostatic discharge!</p> <p>Electrical fields or electrostatic discharge can cause malfunctions due to damaged individual components, integrated circuits, modules, or devices.</p> <ul style="list-style-type: none"> • Only pack, store, transport, and deliver electronic components, modules, or devices in their original packaging or in other suitable materials, e.g., conductive foam rubber or aluminum foil. • Only touch components, modules, and devices when you are grounded by one of the following methods: By an ESD wrist strap or ESD footwear or ESD grounding straps in ESD areas with a conductive floor. • Only place electronic components, modules, or devices on conductive surfaces (table with ESD surface, conductive ESD foam, ESD packaging or ESD transport container).

3.7 Disclaimer of liability

The contents of this document have been checked for consistency with the hardware and software described. Since variance cannot be precluded entirely, we cannot guarantee full consistency. The information given in this document is reviewed at regular intervals and any corrections that might be necessary are made in the subsequent editions.

!	NOTICE
	<p>In the event of operation in a fire or in emergency mode, the equipment and device protection functions are disabled.</p> <p>As a result, damage may occur to the device and the equipment.</p> <ul style="list-style-type: none"> • Only activate fire or emergency mode if the continuous operation of the drive (fan) is absolutely necessary, e.g., in order to ensure that smoke and heat are extracted in the event of the building being evacuated.

4 Product information

4.1 Product description

SINAMICS G120P variable speed drives provide open-loop and closed-loop speed control functions for pump and fan motors in building management applications. The variable speed drive is modular in design. The following components are combined to create the SINAMICS G120P variable speed drive:

- **CU230P-2-BT Control Unit:** Controls and monitors the Power Module and the connected motor.
Further information: Chapter CU230P-2-BT Control Unit [→ 22]
- **PM230 Power Module:** Provides drive power in the ratings range from 0.75 kW to 90 kW.
Further information: Chapter PM230 Power Module [→ 23]
- **Operator panel (optional):** Unit for operating and parameterizing the variable speed drive.
Further information: Chapter Operator panels [→ 24]

The CU230P-2-BT Control Unit can operate with all series PM230 Power Modules.

**NOTICE**

The operator panel or blanking cover is not included in the standard scope of supply and must be ordered separately.

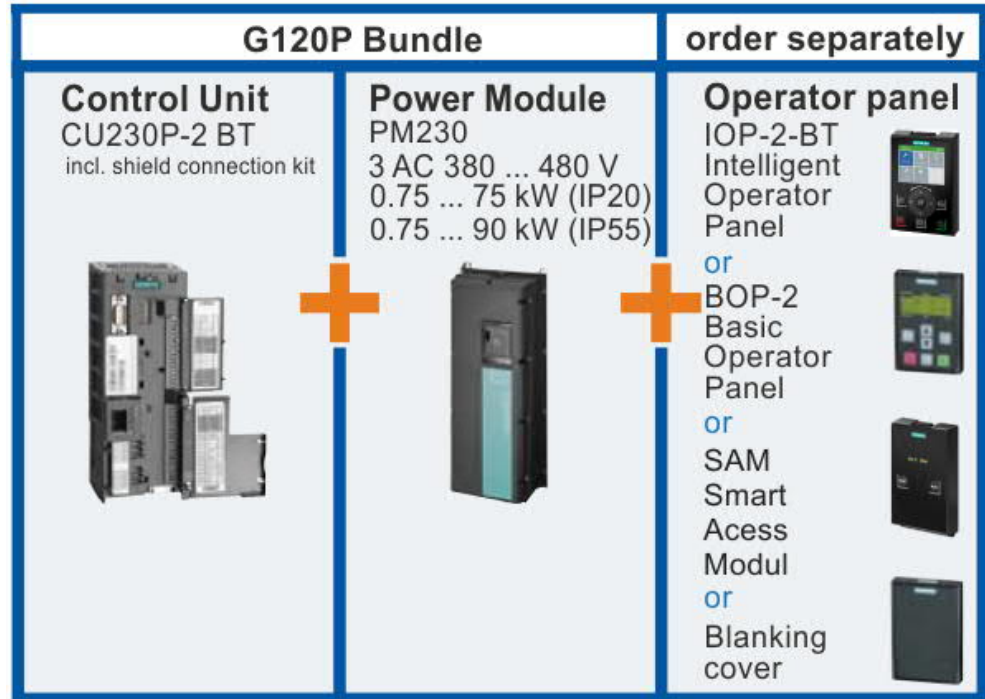

Figure 3: G120P bundle

Optional accessory	Spare parts
Memory cards	Small mounting parts
PC inverter connection kit 2	Fan units
CU230P-2 DP (PROFIBUS DP)	
CU230P-2 PN (PROFINET IO)	
G120P-DOOR-KIT (DOOR-KIT for IOP-2-BT/BOP-2)	

4.2 Components

Below you will find all the information you need to know about the SINAMICS G120P variable speed drive and its components, together with a description of potential applications.

Overview of main components (examples)

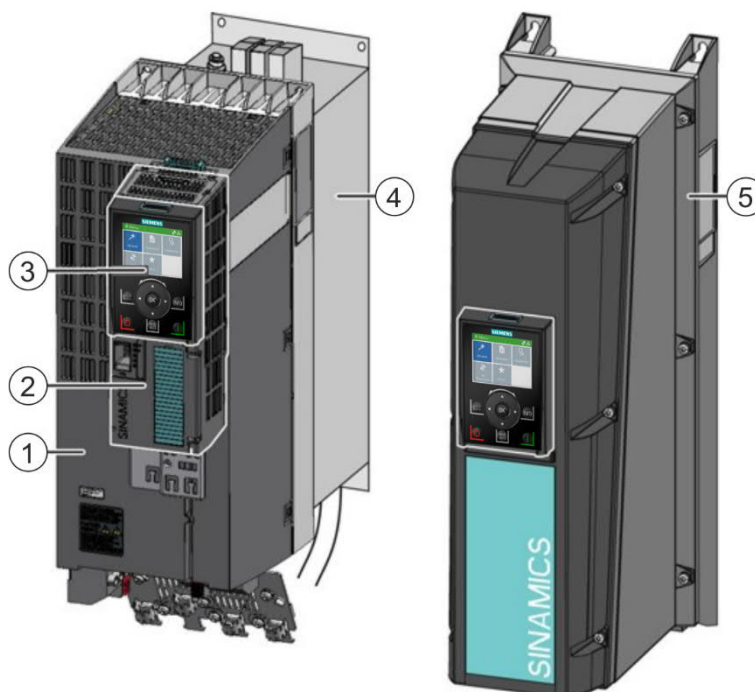

Figure 4: Overview of variable speed drive (examples)

Item	Designation
1	PM230 Power Module (IP20) [→ 23]
2	CU230P-2-BT Control Unit [→ 22]
3	IOP-2-BT Intelligent Operator Panel [→ 24]
4	Base components (filters, reactors or braking resistors)
5	PM230 Power Module (IP54) with IOP-2-BT attached [→ 23]

4.2.1 CU230P-2-BT Control Unit

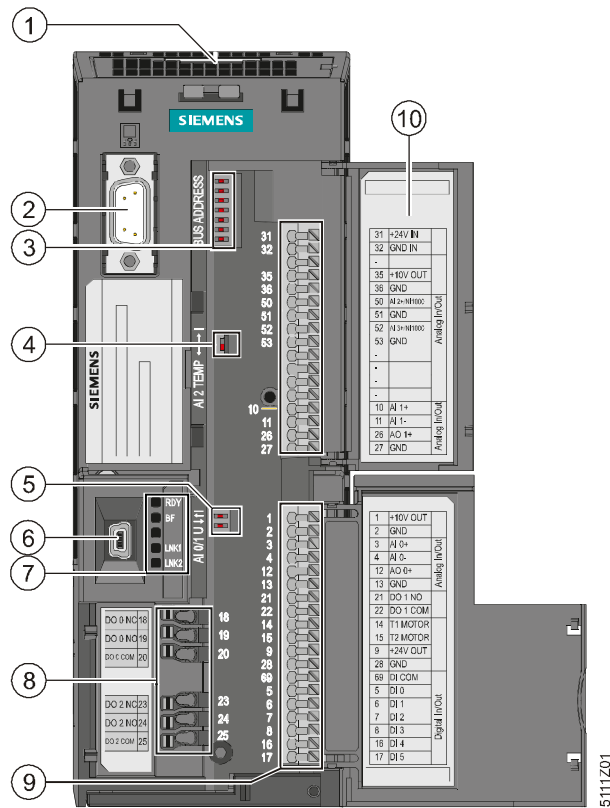

Figure 5: CU230P-2-BT Control Unit

Item	Designation	Details
1	Slot for memory card (MMC or SD card)	
2	Operator panel interface (IOP-2-BT, BOP-2 or SAM)	
3	DIP switches for fieldbus address, incl. example (not needed with PROFINET)	
4	NI1000 DIP switches for AI2 (terminals 50/51)	
5	DIP switches for AIO and AI1 (terminals 3/4 and 10/11)	
6	USB interface for "STARTER" software	
7	Status LEDs	<p>Chapter Displayed operating states [→ 96]</p>

Item	Designation	Details
8	Digital outputs	
9	Terminal strip	Chapter Wiring terminal strips [→ 44]
10	Terminal designation	

The fieldbus interfaces are located on the bottom of the Control Unit.

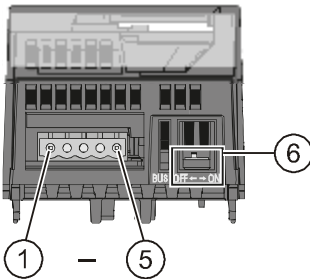

Figure 6: RS485 interface connector

Item	Designation
Pin 1	0 V, reference potential
Pin 2	RS485P, receive and transmit (+)
Pin 3	RS485N, receive and transmit (-)
Pin 4	Cable shield
Pin 5	Not connected
6	Switch for bus terminating resistor

4.2.2 PM230 Power Module

The PM230 Power Module is designed for applications involving pumps, fans and compressors with a square characteristic. The PM230 Power Module is available in the following versions:

Criterion	Version
Frame size	FSA-FSF (Framesize A – Framesize F)
Filter	A: Power Modules with integrated filter Class A can be deployed in installations according to EN 61800-3 categories C3 and C2.
	B: Power Modules with integrated filter Class B also comply with the EMC limit values according to EN 61800-3 category C1 for cable-conducted interference voltages.
IP protection class	Built-in units in degree of protection IP20 for installation in control cabinets.
	Units for wall mounting in degree of protection IP55 .

Table 1: Power Module versions

	IP55	IP20
Frame size FSA - FSC		
Frame size FSD- FSF		

Table 2: Overview of Power Modules

4.2.3 Operator panels

Operator panels are used to commission, diagnose and control the variable speed drive. Use of an operator panel is optional. If an operator panel is not required, it can be replaced by a blanking cover. A variable speed drive without an operator panel is commissioned via an external computer on which the "STARTER" software is installed.

The following operator panels are compatible with G120P variable speed drives:

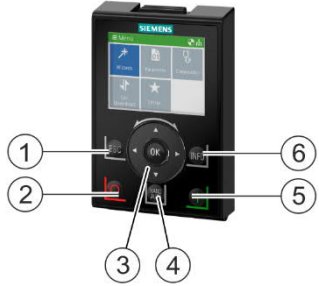
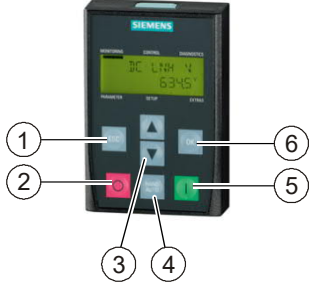
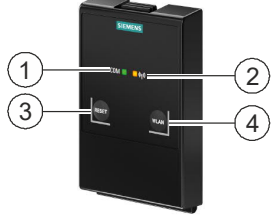
IOP-2-BT (Intelligent Operator Panel)	BOP-2 (Basic Operator Panel)	SAM (Smart Access Module)
		
<ul style="list-style-type: none"> • Plain text display • Menu-based operation and application wizards • Back-up and transfer of variable speed drive settings 	<ul style="list-style-type: none"> • Two-line display • Guided basic commissioning • Back-up and transfer of variable speed drive settings 	<ul style="list-style-type: none"> • Wireless operation via WLAN connection • Integrated description • HTML5 user interface

Item	Function	Item	Function	Item	Function
1	ESC	1	ESC	1	COM-LED
2	OFF	2	OFF	2	WLAN-LED
3	Navigation-sensor field and OK button	3	Arrow keys	3	Reset button
4	MANUAL/AUTO	4	MANUAL/AUTO	4	WiFi On/Off button
5	ON	5	ON	On the rear: <ul style="list-style-type: none"> • Type plate • RS232 plug 	
6	INFO	6	OK		

Operator controls and screen symbols

IOP-2-BT - operator controls







Button	Description
	<p>Navigation-sensor field:</p> <ul style="list-style-type: none"> • Change selection • Change parameters <ul style="list-style-type: none"> – Clockwise rotation increases the value – Counter-clockwise rotation reduces the value <p>Pressing the button:</p> <ul style="list-style-type: none"> • Confirm selection <p>Pressing and holding down the button (> 3 s)</p> <ul style="list-style-type: none"> • Toggle between changing individual digits and changing the whole value
	<ul style="list-style-type: none"> • In AUTO mode: no function • In MANUAL mode: pressing starts the variable speed drive
	<ul style="list-style-type: none"> • In AUTO mode: no function • In MANUAL mode: <ul style="list-style-type: none"> – Pressing briefly: OFF1 - the motor comes to a standstill along the set down ramp (parameter P1121) – Pressing and holding down the button (> 3 s) or pressing it briefly twice: the motor coasts to a standstill
	<ul style="list-style-type: none"> • Pressing briefly: return to the previous display • Pressing and holding down the button (> 3 s): the IOP returns to the status screen
	<p>Pressing the button:</p> <ul style="list-style-type: none"> • Information output about the actual display • You return to the previous display by pressing again
	<ul style="list-style-type: none"> • Pressing the button: Toggle between external command sources and the IOP as command source. <ul style="list-style-type: none"> – MANUAL means: manual control using the IOP buttons – AUTO means: the drive responds to external control commands (e.g. fieldbus or terminals)

Table 3: IOP-2-BT operator controls

IOP-2-BT - screen symbols















Function	Status	Symbol	Comments
Command source	Auto		Auto - the converter receives the command signals from the network controller
	JOG		Is displayed if the JOG function is activated
	Manual		Hand - the converter is under control of the IOP-2-BT
Variable speed drive state	Ready		
	In operation		Symbol rotates when the motor is running.
Fault display	Fault		
Alarm display	Alarm		
Save in the RAM	Active		Indicates that all recent changes to parameters have been saved in RAM only. In the event of a power failure, then all recent changes saved to RAM will be lost. To prevent loss of parameter data a RAM-to-ROM save must be performed.
PID autotuning	Active		
Hibernation	Active		
Write protection	Active		Parameters cannot be changed.
Know-how protection	Active		Parameters cannot be viewed or modified
ESM	Active		Essential services mode (fire control)
Battery condition	Active		The battery status is only shown when the IOP-2-BT Hand-held kit is used.

Table 4: IOP-2-BT screen symbols

BOP-2 - operator controls











Button	Function
	<ul style="list-style-type: none"> Pressing the button: Confirm selection Pressing and holding down the button (> 3 s): Toggle between changing individual digits and changing the whole value
	<ul style="list-style-type: none"> Pressing the button: <ul style="list-style-type: none"> Scroll up through the menu Increase a parameter value Pressing the UP and DOWN buttons simultaneously when MANUAL and JOG mode are activated: Switch the reverse function on and off
	<ul style="list-style-type: none"> Pressing the button: <ul style="list-style-type: none"> Scroll down through the menu Reduce a parameter value Pressing the UP and DOWN buttons simultaneously when MANUAL and JOG mode are activated: Switch the reverse function on and off
	<ul style="list-style-type: none"> Pressing briefly: return to the previous display Pressing and holding down the button (> 3 s): The BOP-2 returns to the status screen
	<ul style="list-style-type: none"> In AUTO mode: no function In MANUAL mode: pressing starts the variable speed drive
	<ul style="list-style-type: none"> In AUTO mode: no function In MANUAL mode: <ul style="list-style-type: none"> Pressing briefly: OFF1 - the motor comes to a standstill along the set down ramp (parameter P1121) Pressing and holding down the button (> 3 s) or pressing it briefly twice: the motor coasts to a standstill
	<ul style="list-style-type: none"> Pressing the button: Toggle between external command sources and the BOP-2 as command source. <ul style="list-style-type: none"> MANUAL means: manual control using the BOP-2 buttons AUTO means: the variable speed drive responds to external control commands (e.g. fieldbus or terminals)

Table 5: BOP-2 operator controls

BOP-2 - screen symbols

Function	Status	Symbol	Comments
Command source	Manual		No symbol is displayed if AUTO mode is activated.
Variable speed drive state	Ready		Static symbol, does not rotate.
JOG function	Active	JOG	Is displayed if the JOG function is activated.
Fault or alarm display	Fault or alarm		<ul style="list-style-type: none"> Flashing symbol: <ul style="list-style-type: none"> A command is active. The variable speed drive stops. Clear the fault. Non-flashing symbol: <ul style="list-style-type: none"> There is an alarm (e.g., overtemperature). The variable speed drive keeps running.

6: BOP-2 screen symbols

SAM - operator controls

Button	Function
Reset	<ul style="list-style-type: none"> Holding down the button for more than three seconds when the SINAMICS G120 Smart Access is in power-on state resets the Wi-Fi configuration of the SINAMICS G120 Smart Access to factory defaults. Holding down the button when the SINAMICS G120 Smart Access is in power-off state and powering on the module enters basic upgrading mode
WLAN	Holding down the button for more than three seconds enables/disables the Wi-Fi connection of the SINAMICS G120 Smart Access.

Tab. 7: SAM operator controls

SAM – LED status

LED	Color	Description
Converter communication	Solid red	The communication between the module and the converter is not established.
	Solid green	The communication between the module and the converter is established.
Wi-Fi communication	Solid red	The network communication is initializing.
	Solid yellow	The network initialization completes but the module is not connected to a PC or mobile device.
	Solid green	The connection between the module and the PC or mobile device is set up and you can open the Web pages now.
	Flashing green	The connection between the module and the PC or mobile device is set up and the Web page is open.
	Flashing yellow	The module requires a restart because an upgrade is completed or the Wi-Fi configuration is modified.
	Alternating flashing red and yellow	The module is upgrading.

Tab. 8: SAM LED status

4.3 License terms

The variable speed drive contains open source software (OSS). The license terms for the open source code are stored in the variable speed drive.

Transferring the license terms

To transfer the OSS license terms from the variable speed drive to a PC, proceed as follows:

1. Switch off the variable speed drive power supply.
2. Insert an empty memory card into the card slot of the variable speed drive.
3. Switch on the variable speed drive power supply.
4. When you have switched on the power supply, wait 30 seconds. During this time, the device writes the "Read_OSS.ZIP" file onto the memory card.
5. Switch off the variable speed drive power supply.
6. Remove the card from the device.
7. Use a card reader to import the file to a PC.





For information about firmware upgrade and downgrade options, please go to [SIOS-Entry 67364620](#).

5 Installing

5.1 Safety instructions for installation

	<p>⚠ DANGER</p>
	<p>Risk of injury due to hazardous voltages! Variable speed drives are at hazardous voltage levels and control the speed and direction of rotation of motors. Touching live parts can result in serious physical injury or death.</p> <ul style="list-style-type: none"> • Make sure that the variable speed drive is installed and commissioned by qualified personnel.

	<p>⚠ WARNING</p>
	<p>Danger to life due to electromagnetic fields! Variable speed drives generate electromagnetic fields (EMF) in operation. People with pacemakers or implants are at particular risk in the immediate vicinity of these devices/systems.</p> <ul style="list-style-type: none"> • If you have a heart pacemaker or implant, maintain a minimum distance of 2 m. • Display an appropriate warning symbol in the area around the variable speed drive.

	<p>⚠ DANGER</p>
	<p>Danger to life through electric shock due to unconnected cable shields! Hazardous touch voltages can occur through capacitive cross-coupling due to unconnected cable shields.</p> <ul style="list-style-type: none"> • Connect cable shields and unused cores of power cables (e.g., brake cores) to the grounded housing potential at least at one end.

	<p>⚠ WARNING</p>
	<p>Risk of injury due to improper use! Unauthorized use or modifications to the variable speed drive can result in fires, electric shocks and injuries.</p> <ul style="list-style-type: none"> • Do not use the device for any applications other than those described in the catalog and other relevant documentation. • Do not carry out any modifications to the device. • Only use spare parts and accessories which are distributed or recommended by the manufacturer of the device. • Do not use the variable speed drive as an "emergency stop device" (see EN 60204, 9.2.5.4).



NOTICE

Danger of property damage due to unsuitable site of installation!

Unsuitable ambient conditions can damage the device by impairing its ability to function properly.

- Only install the variable speed drive in areas which are free from jolts, vibrations, electromagnetic fields, and corrosive gases.
- Maintain the ambient conditions which are specified in the technical data, such as temperature, pressure, humidity, etc. (Chapter Technical data [→ 111]).
- Ensure that the correct level of ventilation and air flow is provided.
- IP20 devices may only be operated in closed housings or in higher-level control cabinets with protective covers that are closed, and when all of the protective devices are used.

5.2 Overview of installation



For detailed information about installation, please refer to chapter "Installation" in the Operating Instructions for the Control Unit (A5E34257946B).

The process of installing a variable speed drive involves the following steps. Please carry these out in the specified sequence:

Step	Activity	Additional information
1	Where applicable, install the accessories (reactors, filter or braking resistor) for the Power Module	<ul style="list-style-type: none"> • Instructions that are supplied with the accessories • Operating Instructions for the Control Unit (A5E34257946B), Chapter 4.3
2	Installing Power Modules [→ 33]	<ul style="list-style-type: none"> • Operating Instructions for the Control Unit (A5E34257946B), Chapter 4.4
3	Connecting line and motor terminals [→ 34]	<ul style="list-style-type: none"> • Operating Instructions for the Control Unit (A5E34257946B), Chapter 4.5.2
4	Installing the Control Unit [→ 43]	<ul style="list-style-type: none"> • Operating Instructions for the Control Unit (A5E34257946B), Chapter 4.6
5	Wiring terminal strips [→ 44]	<ul style="list-style-type: none"> • Operating Instructions for the Control Unit (A5E34257946B), Chapter 4.6.3
6	Where applicable, install the Installing the operator panel [→ 47]	
7	Commissioning the variable speed drive [→ 54]	<ul style="list-style-type: none"> • Operating Instructions for the Control Unit (A5E34257946B), Chapter 5

5.3 Installing the Power Module

5.3.1 Installing Power Modules



For information about dimensions, drilling templates, minimum clearances and tightening torques, please refer to the Operating Instructions for the Control Unit A5E34257946B, [SIOS-Entry-ID: 109782866](#).

IP20 devices



IP20 devices must be protected against conductive pollution, e.g., by installing them in a control cabinet with IP54 degree of protection according to IEC 60529 or NEMA 12. Provided conductive pollution can be prevented at the installation site, the degree of protection for the cabinet can be decreased accordingly.

1. Position the Power Module in the control cabinet so that you can connect the cables for the motor and line supply in accordance with the terminal layout. Please note that the Power Module must always be mounted vertically.
2. Please use the fixing materials supplied in order to mount the Power Module in the control cabinet. Please observe the following:
 - Maintain the minimum required clearances to other components in the control cabinet.
 - Do not exceed the maximum specified tightening torques for fastenings.

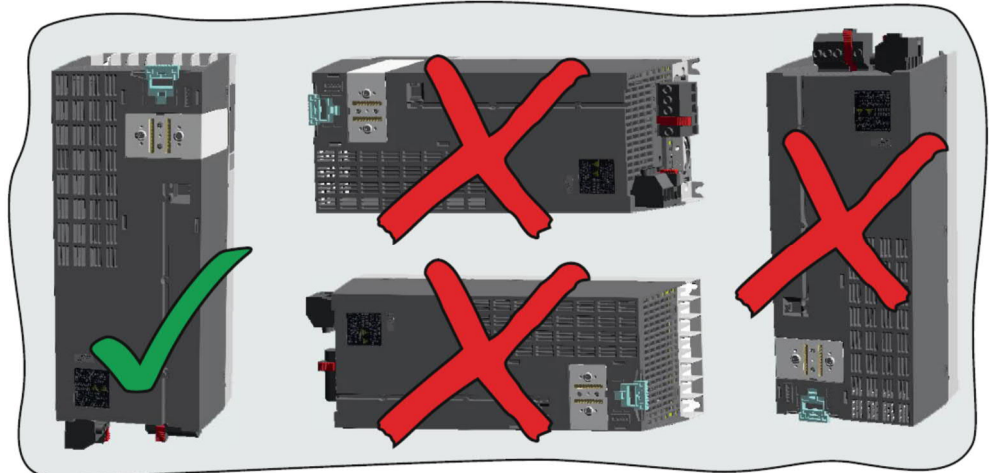

Figure 7: Mounting direction

IP55 devices



To ensure the cooling capacity, IP55 devices in frame sizes FSA to FSC must be mounted directly onto a flat wall. If this is not possible, for example in the case of a suspended installation on a busbar system, an air guide sheet (available separately) must be attached.

The variable speed drive must be mounted on an unpainted metal surface in order to comply with EMC requirements.

5.3.2 Connecting line and motor terminals

5.3.2.1 Overview of line and motor connections

The following diagrams show the arrangements of the line and motor terminals on the relevant Power Module of frame sizes FSA to FSF. The permissible tightening torques for terminals are listed in the table titled "Overview of tightening torques".

IP20 FSA...FSC

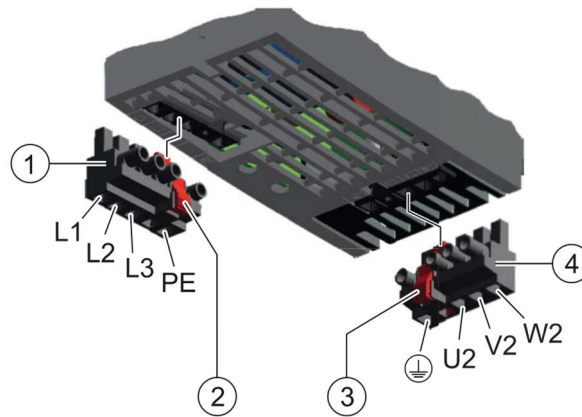

Figure 8: IP20 FSA-FSC

Item	Designation
1	Detachable mains connector
2	Release lever
3	Release lever
4	Detachable motor connector



The Power Modules are equipped with two-part connectors. You can remove the detachable part of the connector from the Power Module by pressing the unlocking device. The connectors cannot be mixed up.

IP20 FSD...FSF

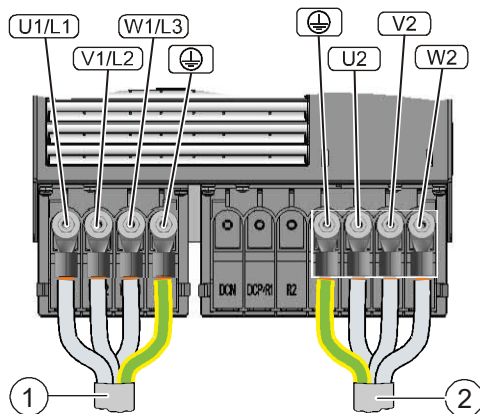

Figure 9: IP20 FSD-FSF

Item	Designation
1	Power supply
2	Motor connection

IP55 FSA...FSC

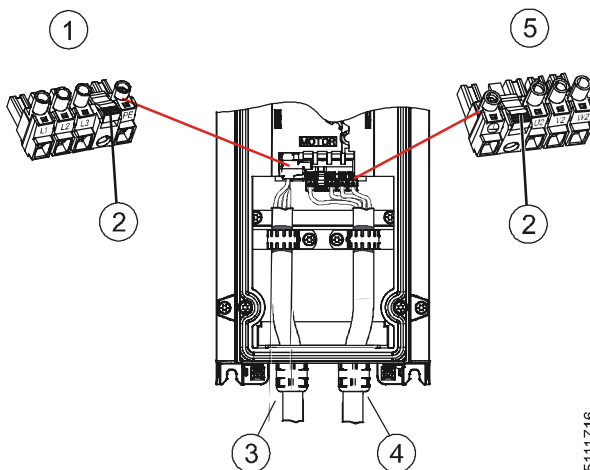

Figure 10: IP55 FSA-FSC

Item	Designation
1	Detachable mains connector
2	Release lever
3	Connection of supply voltage
4	Motor connection
5	Detachable motor connector

IP55 FSD...FSF

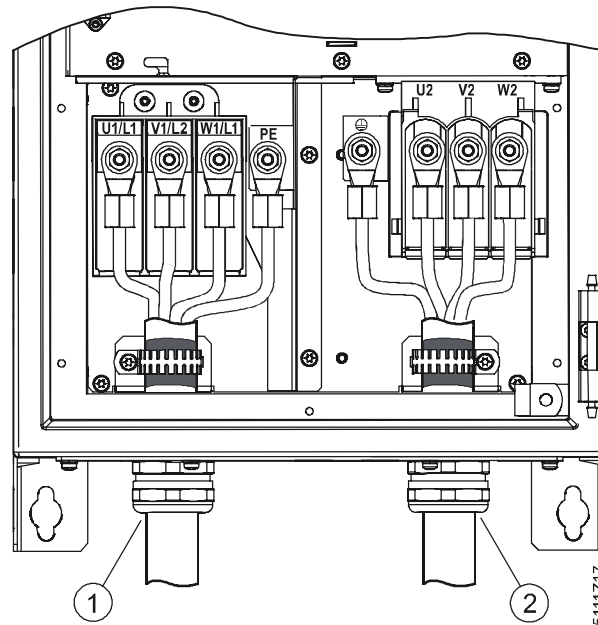

Figure 11: IP55 FSD-FSF

Item	Designation	Item	Designation
1	Connection of supply voltage	2	Motor connection

Overview of tightening torques

	FSA	FSB	FSC	FSD	FSE	FSF
IP20	0.4 Nm... 0.5 Nm	0.55 Nm... 0.6 Nm	1.2 Nm... 1.5 Nm	6 Nm	6 Nm	13 Nm
IP55	0,5 Nm (4,4 lbf.in)	0,6 Nm (5,3 lbf.in)	1,5 Nm (13,3 lbf.in)	M6: 6 Nm (53,0 lbf.in)	M6: 6 Nm (5,3 lbf.in)	M8: 13 Nm (115 lbf.in)

Table 9: Overview of tightening torques

5.3.2.2 Overview of motor cable lengths and cross sections

The following tables contain all relevant information about required cable lengths and cross sections. Adherence to the specified values is essential in order to ensure that the installation complies with EMC regulations.

Cable specifications

PM230	Cable type	EMC category	Max. cable length
Filter A	Shielded	C2	25 m (80 ft)
	Shielded	C3	50 m (164 ft)
	Unshielded	No	100 m (330 ft)
Filter B	Shielded	C1 (conducted only)	25 m (80 ft) with IP54 50 m (164 ft) with IP20
	Shielded	C2	50 m (164 ft)
	Unshielded	No	100 m (330 ft)

- You may only use copper wire of class 1, 75 °C (for compliance with the UL in frame sizes A to C).
- Ensure that the appropriate circuit breakers or fuses with the specified current rating are connected between the power supply and the drive.

Cross sections of power cables

Frame size	Rating	Cable cross-section		Tightening torques	
	kW	mm ²	AWG	Nm	lbf in
FSA	0.37...1.5	1.0 ... 2.5	18...14	0.5	4.4
	2.2...3	1.5...2.5	16...14	0.5	4.4
FSB	4	2.5...6.0	14...10	0.6	5.3
	5.5...7.5	4.0...6.0	12...10	0.6	5.3
FSC	11	6.0 ... 16	10 ... 5	1.5	13.3
	15...18.5	10 ... 16	7 ... 5	1.5	13.3
FSD	22.0...30	10...35	5...2	6	53
	37	25...50	3...2	6	53
FSE	45	35...50	2...4/0	6	53
	55	70...120	2/0...4/0	13	115
FSF	75...90	95...120	3/0...4/0	13	115
	0.37...1.5	1.0 ... 2.5	18...14	0.5	4.4

Cable cross-section of the grounding conductors

- The material of the protective grounding conductor must be the same as the material of the power cable. If this is not the case, the specific resistance of the protective grounding conductor must not be higher than the specific resistance of the power cables. The relevant diameter of the power cables is the diameter of the line supply cable, and not the diameter of the motor cables.
- In the case of power cables up to 35 mm², the ground cable must have a cross section of at least 10 mm² (16 mm² Al).
- For power cables with a diameter of more than 35 mm², the protective grounding conductor must have at least half of the size of the cross-section of the power cable.
- If possible, use at least 16 mm² for the copper equipotential-bonding cable.

Cable types

Diagram	Cable type	Dimensions			
		A	B _{SEP}	C	D
	FSA power cables	10 mm 0.39 inches	60 mm 2.36 inches	-	90 mm 3.54 inches
	FSA motor cables	10 mm 0.39 inches	60 mm 2.36 inches	10 mm 0.39 inches	60 mm 2.36 inches
	FSB motor cables	10 mm 0.39 inches	60 mm 2.36 inches	-	50 mm 1.96 inches
	FSC power cables	10 mm 0.39 inches	50 mm 1.96 inches	10 mm 0.39 inches	40 mm 1.57 inches
	FSC motor cables	10 mm 0.39 inches	50 mm 1.96 inches	-	70 mm 2.75 inches

Table 10: Overview of cables



No shielding dimensions are indicated for the input power cables because they are generally unshielded cables.

Cable preparation

1. Expose the shield around the length C in order to ensure that devices with an EMC filter of Class B conform to EMC category C1.
2. When the cable is fed through the base plate, also expose the shield around the length D (see sketch above, at the end of "D") and insert the cable through the conductively connected EMC cable gland.

5.3.2.3 Connecting line and motor terminals

Instructions on how to connect line and motor terminals are given below:

- For IP20 devices, follow the instructions in Chapter IP20 devices [→ 38] devices.
- For IP55 devices, follow the instructions in Chapter IP55 devices [→ 40] devices.



In addition to the information below, please also read Chapter EMC-compliant installation (examples) [→ 47].

IP20 devices

Overview

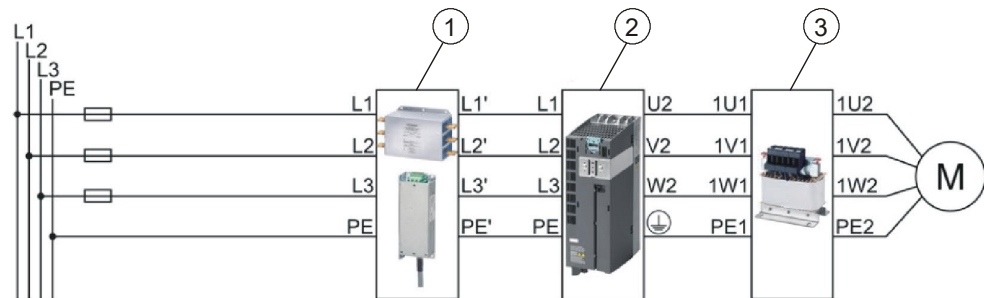

Figure 12: Connection of G120P IP20

Item	Designation
1	Line filter (filter B only)
2	Power Module
3	Sine-wave filter (optional)



NOTICE

Scope of supply for IP20

A screening termination kit for the Power Module PM230 is included with the IP20 devices in frame sizes A to C. For frame sizes D to F, the screening termination kit must be ordered separately if required.

Accessing line and motor terminals

If a terminal cover is fitted, please follow the instructions below in order to access the line and motor terminals:

1. Loosen the safety catch on the sides of the terminal cover using a suitable size of flat-head screwdriver.

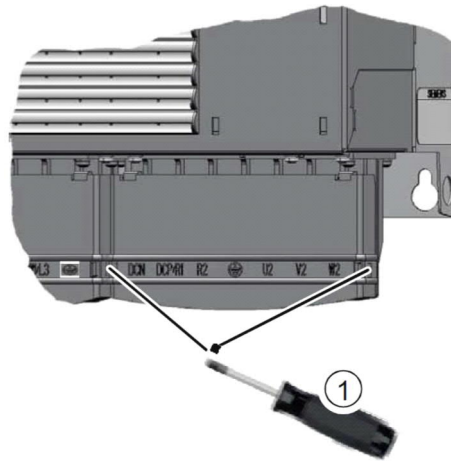

2. Turn the terminal cover up and allow it to engage.

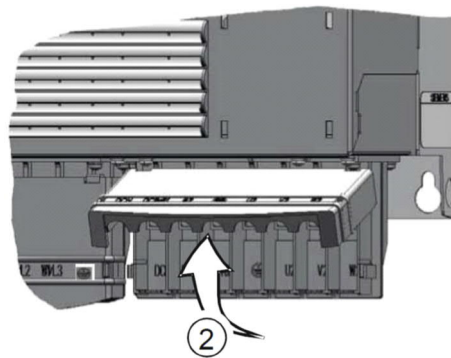

For information about line and motor connections, please refer to Chapter Overview of line and motor connections [→ 34].

Connecting the line supply cable to the variable speed drive

To connect the variable speed drive to the supply system, proceed as follows:

- ▷ The Power Module has been correctly mounted (Chapter Installing Power Modules [→ 33]).
1. Open the terminal covers (if fitted) of the variable speed drive.
 2. Connect the line supply to terminals U1/L1, V1/L2, and W1/L3. Follow the instructions pertaining to EMC-compliant wiring (Chapter EMC-compliant installation (examples) [→ 47]).
 3. Connect the protective conductor of the line supply to terminal PE of the variable speed drive.
 4. Close the terminal covers (if fitted) of the variable speed drive.

Connecting the motor cable to the variable speed drive

To connect the motor cable to the variable speed drive, proceed as follows:

1. Open the terminal covers (if fitted) of the variable speed drive.
2. Connect the motor at terminals U2, V2 and W2. Follow the instructions pertaining to EMC-compliant wiring (Chapter EMC-compliant installation (examples) [→ 47]).
3. Connect the protective conductor of the motor to terminal PE of the variable speed drive.
4. Close the terminal covers (if fitted) of the variable speed drive.

Connecting a motor cable to an induction motor

To connect the motor cable to an induction motor, proceed as follows:

1. Open the motor terminal box.
2. Connect the motor in either a star or delta connection. You can find further information in the Operating Instructions for the Control Unit (A5E34257946B).
3. If you are using a shielded motor cable, you must do the following:
 - Expose the shield of the motor cable in the area of the cable entry in the terminal box.
 - Attach the cable shield to the motor terminal box using a suitable screw connection.
4. Close the motor terminal box.

IP55 devices

Overview

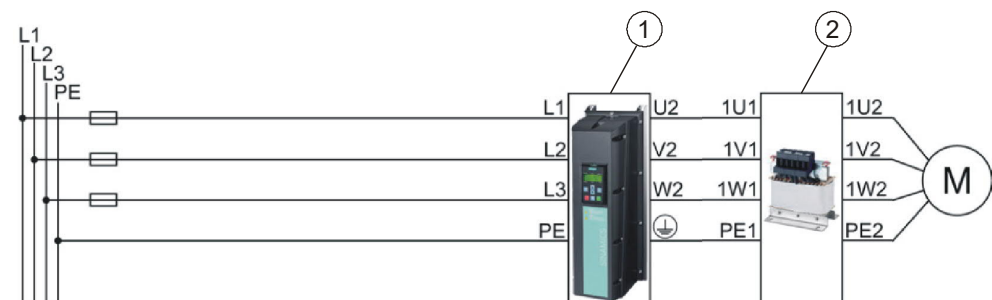

Figure 13: Connection of G120P IP55

Item	Designation
1	Power Module
2	Sine-wave filter or dv/dt filter (optional)

To connect up the line and motor terminals, proceed as follows:

- ▷ The Power Module has been correctly mounted (Chapter Installing Power Modules [→ 33]).
 - ▷ The cover of the Power Module has been removed.
1. Prepare all the cables you will need (Chapter Overview of motor cable lengths and cross sections [→ 36]).
 2. Remove the gland plate. To do this, remove the fixing screws from the gland plate.

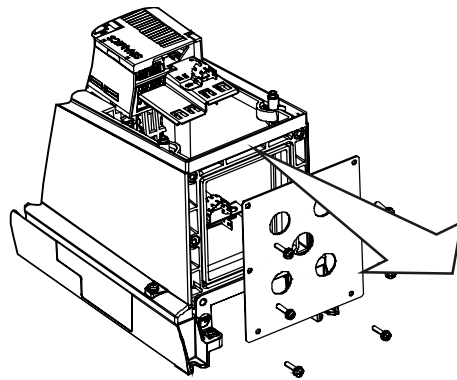

Figure 14: Removing the gland plate

3. Fasten the cable glands to the cables.

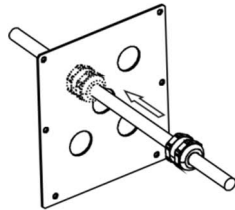

Figure 15: Fastening cable glands

4. Ensure that the screws on the cable glands are loosened so that the cables slide through unhindered.
5. Attach a ferrite core to the motor cable (applies only to Class B filter variants, see "Attaching ferrite rings to motor and line cables").
6. Attach the power and motor cable to the terminals of the Power Module. Follow the instructions pertaining to EMC-compliant wiring (Chapter EMC-compliant installation (examples) [→ 47]).
7. Ensure that the cables are correctly secured through the shielding terminals.
8. Install the gland plate:
 - Press the gland plate against the underside of the Power Module.
 - Make sure that the cables are pulled through the cable glands. This helps to prevent excess cable lengths inside the Power Module housing.
 - Tighten the gland plate applying a maximum tightening torque of 2 Nm (17.7 lbf.in).
 - Check whether the seals are correctly seated; otherwise, it will not have IP55 degree of protection.
 - Tighten the cable glands applying a maximum tightening torque of 2.5 Nm (22.12 lbf.in).
 - Insert rubber grommets into all the holes of the gland plate which are not occupied by cables.

Attaching ferrite rings to motor and line cables



Where ferrite rings are required, they are included in the scope of supply for the product.

Motor cable

In the case of PM230 Power Modules of frame sizes FSA to FSC (0.75 kW...15 kW) with integrated Class B filters, attach the **colored ferrite ring** to the motor power cable in order to meet the requirements set out in EMC category C1 for conducted interference emissions.

- Attach the colored ferrite ring between the terminals of the motor power cable and the shielding plate of the Power Module. Use cables which are shorter than 25 m. Ferrite rings may not be attached to cables measuring more than 25 m (80 ft) in length.

Line cable

In the case of PM230 Power Modules of frame size FSB (4 kW...7.5 kW) and frame size FSC (11 kW ... 15 kW) with integrated Class B filters, the **gray ferrite rings** also have to be attached to the line cable in order to meet the requirements set out in the EMC guidelines for radiated noise.

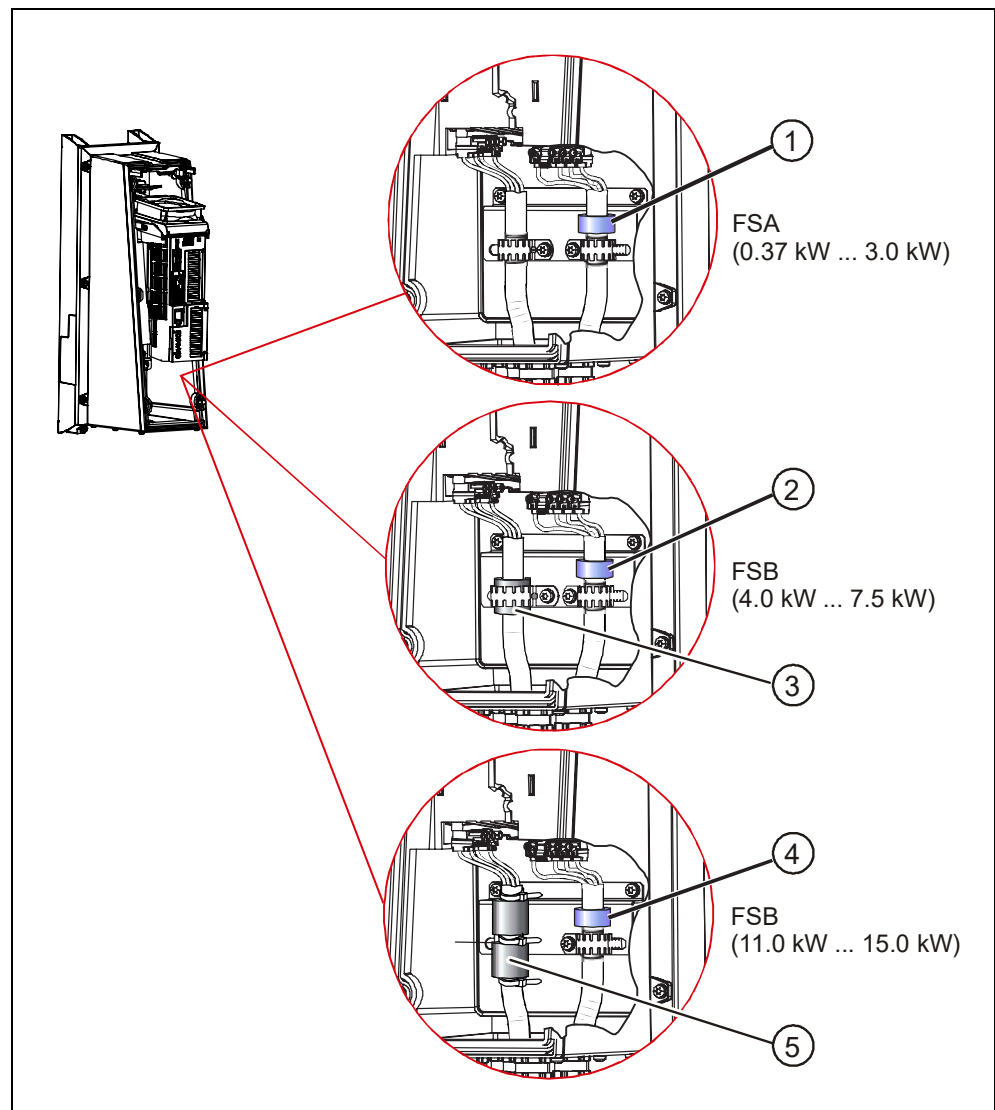

Item	Designation
1	Colored ferrite ring
2	Colored ferrite ring
3	Colored ferrite ring <ul style="list-style-type: none">• 1 x ferrite ring• 1 x large cable clamp
4	Colored ferrite ring
5	Colored ferrite ring <ul style="list-style-type: none">• 2 x ferrite ring• 3 x cable ties

5.4 Installing the Control Unit

5.4.1 Installing the Control Unit

Installing the Control Unit on an IP20 Power Module

Proceed as follows to connect Power Module and Control Unit:

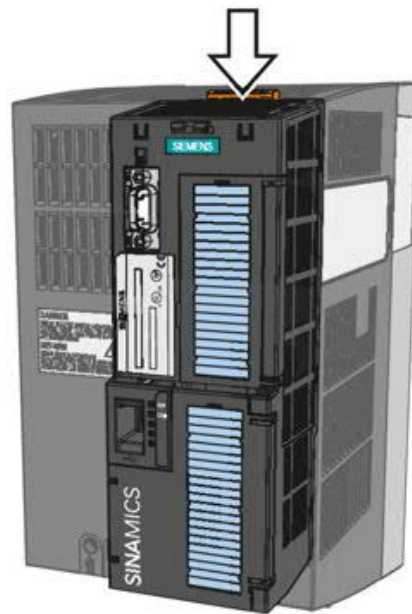

Figure 16: Installing Control Unit - IP20

- ▷ The Power Module has been correctly mounted (Chapter Installing the Power Module [→ 33]).
- ▷ The device is de-energized.
- 1. Locate the lugs at the rear of the Control Unit in the matching recesses of the Power Module.
- 2. Mount the Control Unit onto the Power Module so that it audibly snaps into place.

Installing the Control Unit on an IP55 Power Module

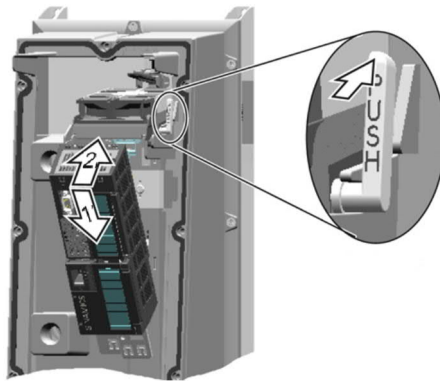

Figure 17: Installing the Control Unit - IP55

- ▷ The Power Module has been correctly mounted (Chapter Installing the Power Module [→ 33]).
- ▷ The device is de-energized.
- 1. Unscrew the cover of the Power Module.
- 2. Locate the lugs at the rear of the Control Unit in the matching recesses of the Power Module.
- 3. Mount the Control Unit onto the Power Module so that it audibly snaps into place.
- 4. Screw the cover of the Power Module back into position.

5.4.2 Wiring terminal strips



To access the interfaces on the Control Unit, you must remove the operator panel (if one is being used) and open the front doors. The terminal settings depend on the application. For more information, refer to Chapter Application examples [→ 82].

5.4.2.1 Overview of terminal strips

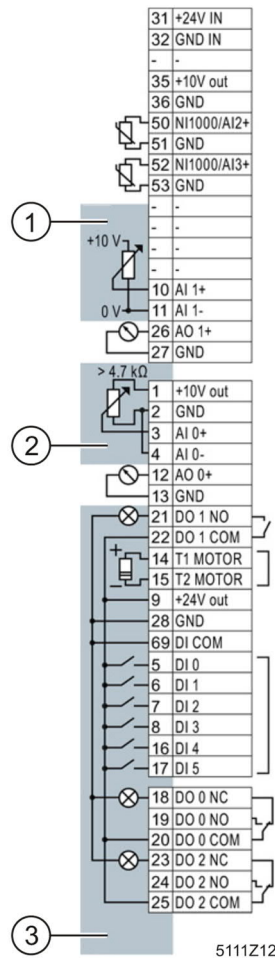

Figure 18: Terminal strips 1-3

Item	Description
1	The analog input is supplied from an external 10 V voltage.
2	The analog input is supplied from the internal 10 V voltage.
3	Wiring when using the internal power supplies. Connecting a contact switching to P.

7. Route the signal cables in such a way that you can completely close the front doors after wiring the terminal strip.
8. If you use shielded cables, then you must connect the shield to the mounting plate of the control cabinet or to the shield support of the variable speed drive through a good electrical connection and a large surface area. See also: EMC design guidelines ([SIOS Entry-ID: 60612658](#)).
9. Use strain relief.

5.5 Installing the operator panel

To connect up the operator panel to the Control Unit, proceed as follows:



Figure 20: Operator panel

1. Fit the operator panel on the Control Unit as illustrated in the diagram.
2. Press the operator panel against the Control Unit until it audibly engages.

5.6 EMC-compliant installation (examples)

Variable speed drives are designed for operation in industrial environments where a high level of electromagnetic interference is likely to be present. Safe, reliable and disturbance-free operation is only guaranteed if the variable speed drive is installed professionally and in compliance with EMC regulations, see also EMC design guidelines, [SIOS Entry-ID: 60612658](#).

Please therefore observe the following installation principles.

General

Connections and interference suppression

- Contactor coils, relays, solenoid valves, and motor holding brakes must feature interference suppressors which reduce high frequency interference when the contacts are opened.
- Create the connections as permanent connections.
- Use special washers which penetrate the insulation surface for screw connections on painted or anodized metal components. This serves to create a metallically conducting contact. Alternatively, you can remove the insulation surface at the contact points.

Cabling

- Lay line and motor cables separate from the signal and data cables. Maintain a minimum clearance of approximately 25 cm.
- Use shielded cables with finely stranded braided shields for the motor cable. Use three-core, symmetrical three-phase cable.
- Lay the shielded power cable to the motor separately from the two motor temperature sensor cables (PTC / KTY / Pt 1000) because they are treated like signal cables.
- Shield the signal and data cables in order to avoid inductive or capacitive interference or stray radiation. Lay particularly sensitive signal cables, such as setpoint or actual value cables, in such a way that optimized and interruption-free shield bonding exists at either end.
- Lay the shields over as large a surface as possible at either end, with optimized electrical conductivity to the grounded enclosure.
- Avoid interruptions in cable shields caused by intermediate terminals or service switches without a conductive metal housing.

EMC-compliant wiring for Power Modules with degree of protection IP20



Install and operate variable speed drives with IP20 degree of protection in a closed control cabinet.

The diagram below shows a typical EMC-compliant installation for devices with degree of protection IP20:

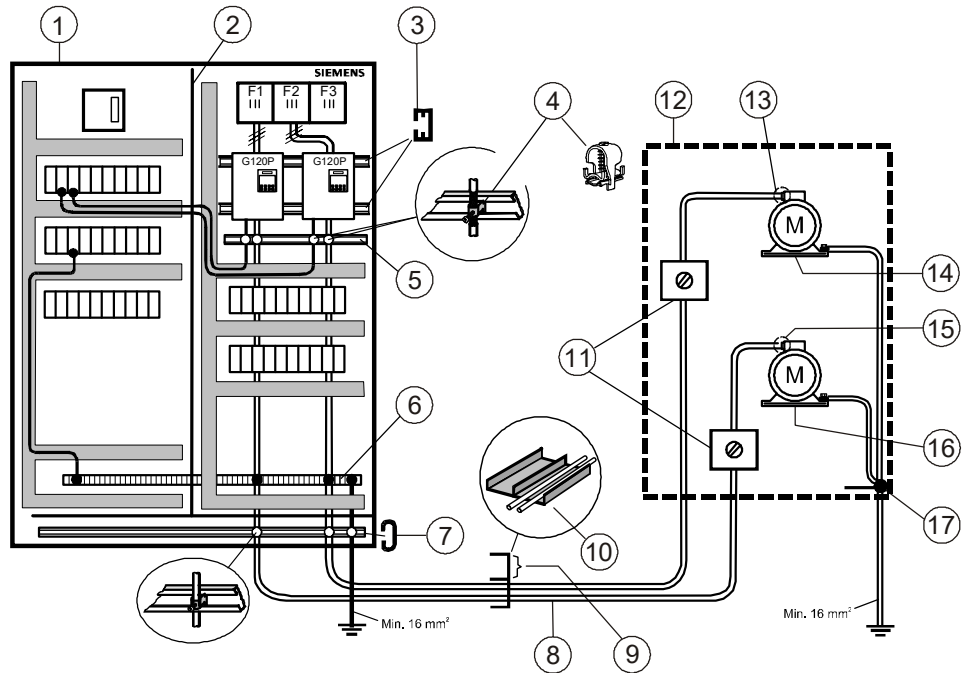

Figure 21: Connection of IP20 devices

Item	Designation	Item	Designation
1	Cabinet	10	Metal cable duct with partition
2	Metal partition	11	Connect cable shields continuously at isolator switch
3	C-section mounting rail	12	Monoblock
4	Shield connection clamp	13	Metal cable gland
5	Shielding bus	14	Supply air
6	Clamping rail	15	Metal cable gland
7	Strain relief rail	16	Discharged air
8	Motor cable (shielded)	17	Potential bonding
9	Signal and control cables (shielded)		

Using two examples, the following diagram shows the EMC-compliant installation of the Power Module with and without shield plate.



You must use the shield plate to achieve EMC-compliant installation of devices in frame sizes FSA to FSC.

The shield of the control cable must be attached to both the shield plate of the Control Unit and the shield plate of the Power Module.

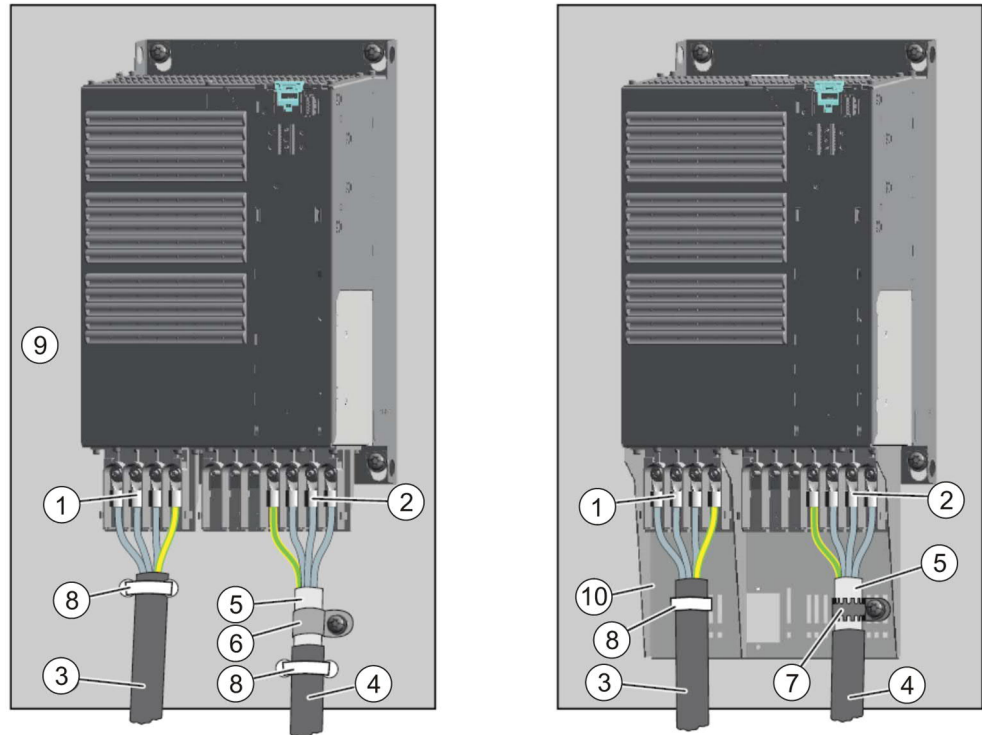
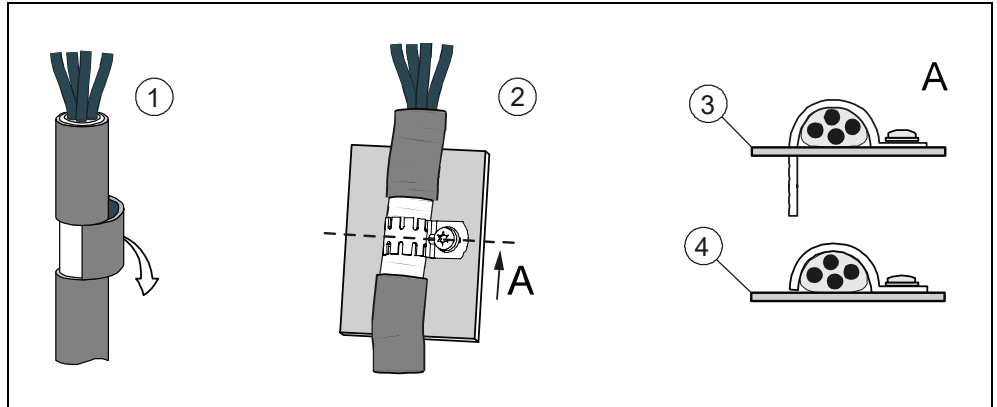

Figure 22: EMC-compliant wiring IP20

Item	Designation
1	Line connection cable (unshielded) for Power Modules with integrated line filter. If you use an external line filter, you will need a shielded cable between the line filter and the Power Module.
2	Motor connection
3	Line supply cable (unshielded)
4	Motor connection cable (shielded)
5	Cable shield
6	Cable clamps for establishing the connection between the shield and the mounting plate over a large surface area
7	Serrated collar
8	Cable tie
9	Metal mounting plate (unpainted and with a good electrical conductivity)
10	Shield plate (option)



Item	Designation
1	Expose the cable shield
2	Press cable shield onto the shield/mounting plate
3	Shield plate
4	Mounting plate

EMC-compliant wiring for Power Modules with degree of protection IP55



Variable speed drives with degree of protection IP55 are suitable for installation outside a control cabinet.

The diagrams below show examples of EMC-compliant installation for devices with degree of protection IP55:

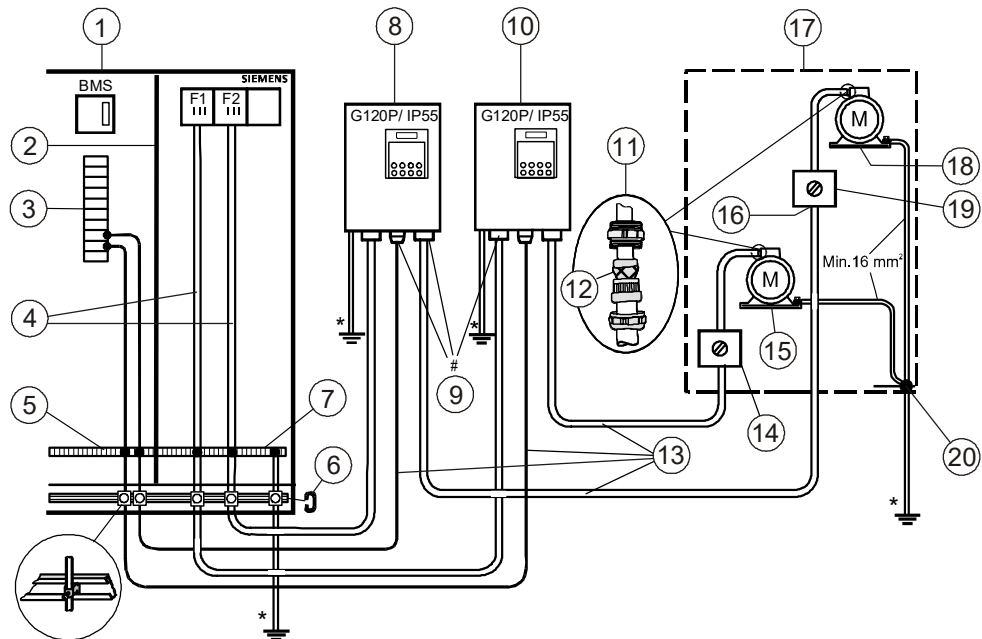

Figure 23: Connection of IP55 devices

Item	Designation	Item	Designation
1	Cabinet	11	Metal cable gland
2	Metal partition	12	Shielding
3	I/O modules	13	Shielded cables
4	Supply cable (unshielded)	14	Service switch
5	Connecting terminals	15	Discharged air
6	Strain relief rail	16	Connect cable shield continuously
7	Clamping rail and equipotential bonding busbar	17	Monoblock
8	Supply air	18	Supply air
9	Cable gland	19	Service switch
10	Discharged air	20	Potential bonding

* All equipotential bonding cables must have a cross section of at least 16 mm².

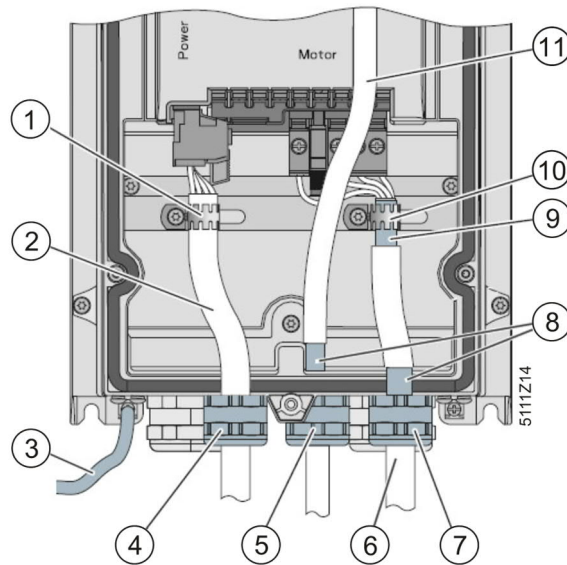

Figure 24: EMC-compliant wiring IP55

Item	Designation	Item	Designation
1	Strain relief	7	EMC gland (essential for Class B filters)
2	Line supply cable, unshielded	8	Shielding
3	Good conductive connection for high-frequency EMC interference	9	Motor cable shield
4	Standard cable gland	10	Shield bonded over large area
5	EMC gland	11	Control Unit control cable
6	Shielded motor cable		

- Use a shielded cable for terminal wiring of the Control Unit.
- Use either the screening termination kit of the Control Unit or an EMC cable gland to bond the shield.
- Expose the motor cable shield at the point where the cable is fed through the base plate and ensure that it is in complete contact with an EMC cable gland. It is important for the shield to be fed through the cable gland and then to be connected at the designated place inside the enclosure once again. This ensures that both the gland plate and the enclosure are in contact with the shield.
- Feed the motor cable through the right-hand opening in the gland plate.

6 Commissioning

6.1 Safety instructions for commissioning



⚠ WARNING

Risk of injury due to uncontrolled movements!

Loads can move uncontrollably when the connected motor is switched on for the purpose of motor data identification. These movements can cause serious injury.

- Before switching on, check that no parts are loose on the machine or can be spun out.
- Before switching on, ensure that nobody is working on the machine or located within the hazardous area around the machine.
- Take measures to prevent unauthorized access to the hazardous area around the machine.
- Lower hanging/suspended loads to the floor.

6.2 Overview of the commissioning



For detailed information about the commissioning process, please refer to chapter "Commissioning" in the Operating Instructions for the Control Unit (A5E34257946B).

The process of commissioning a variable speed drive involves the following steps. Please carry these out in the specified sequence:

Step	Activity	Additional information
1	Define the requirements to be met by the drive for your application [→ 55].	• Operating Instructions for the Control Unit (A5E34257946B), Chapter 5.2.3
2	Restore the factory settings on the variable speed drive if necessary [→ 74].	• Operating Instructions for the Control Unit (A5E34257946B), Chapter 5.5
3	Check whether the factory setting of the drive is appropriate for your application. If not, start basic commissioning [→ 55].	• Operating Instructions for the Control Unit (A5E34257946B), Chapter 5.2.2
4	Check whether you need to adapt the functions of the terminal strip that you specify in the basic commissioning.	• Operating Instructions for the Control Unit (A5E34257946B), Chapter 4.6.5
5	If necessary, adapt the communications interface in the variable speed drive [→ 70].	• Operating Instructions for the Control Unit (A5E34257946B), Chapter 4.6.7
6	If necessary, set further functions in the variable speed drive [→ 74].	• Operating Instructions for the Control Unit (A5E34257946B), Chapter 6.7
7	Save your settings [→ 80].	• Operating Instructions for the Control Unit (A5E34257946B), Chapter 7
8	Fill out the commissioning log and enclose it with the plant documentation [→ 117].	

6.3 Preparing for commissioning

Before starting commissioning, you must know the answer to the following questions:

Variable speed drive

- What data does my variable speed drive have?
- Which interfaces of the variable speed drive are active?
- How is the variable speed drive integrated in the higher-level control system?
- How is my variable speed drive set?
- What technological requirements must the drive fulfill?

Motor

- Which motor is connected to the variable speed drive?
- In which region of the world is the motor used?
- How is the motor connected?
- What is the operating temperature of the motor?



For further information about the individual questions above, please refer to Chapter 5.2 in the Operating Instructions for the Control Unit (A5E34257946B).

6.4 Carrying out basic commissioning

Basic commissioning is the first step of the commissioning procedure. The BOP-2 and IOP-2-BT operator panels guide you through the basic commissioning process and prompt you to enter the most important data of your variable speed drive. Basic commissioning is also possible with the SAM (Smart Access Module), see A5E43332549, [SIOS Entry-ID: 109792113](#).



NOTICE

If you are using the variable speed drive without operator panel, you can perform basic commissioning with an external computer and the STARTER software. Please refer to the Operating Instructions for the Control Unit (A5E34257946B), Chapter 5.4.2.







Commissioning with BOP-2



For further information on technical data, commissioning and operation of the G120P with BOP-2, see A5E37143404B, [SIOS Entry-ID: 109483379](#).

To enter the data for basic commissioning with the BOP-2, proceed as follows:

	<ol style="list-style-type: none"> 1. Press the keys ESC, ▲ and ▼ to navigate to the SETUP menu. 2. To start the basic commissioning process, press OK.
	<ol style="list-style-type: none"> 1. Use key OK and then keys ▲ and ▼ to choose between "YES" (restore factory settings) or "NO" (do not restore factory settings). 2. Press OK to confirm your selection. <p>⇒ The next step in the commissioning process is then displayed automatically.</p>
	<p>Set the regional settings for the motor, e.g. kW and Hz. Press OK and then ▲ and ▼ in order to change the parameter value.</p>
	<p>Specify the overload capability of the drive. LOW OVL (duty cycle with "Low Overload") is normally used. Alternatively: HIGH OVL (duty cycle with "High Overload").</p>
	<p>Enter the supply voltage of the variable speed drive.</p>
	<p>Select the relevant motor type:</p> <ul style="list-style-type: none"> • 1: INDUCT: Induction motor • 2: SYNC: Synchronous motor • 10: 1LE1 induction motor • 13: 1LG6 induction motor • 17: 1LA7 induction motor • 19: 1LA9 induction motor • 100: 1LE1 IND 100, 1LE1□9 motors with motor code on the rating plate
	<p>Select the 50 Hz characteristic. If you wish to use the 87 Hz characteristic, refer to the detailed technical documentation and the application example "Fans in 87 Hz operation" [→ 93].</p>

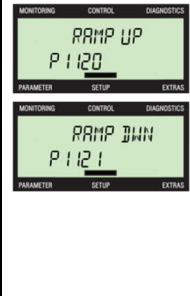
	<p>The motor data settings for</p> <ul style="list-style-type: none"> rated voltage in volts rated current in amperes shaft output in KW or hp rated frequency in Hz rated speed in RPM <p>from the rating plate must match the wiring (star/delta).</p> <ol style="list-style-type: none"> Press OK to change the parameter value. Use keys ▲ and ▼ (or alter individual digits by pressing OK for 3 seconds) in order to change the displayed value. Press OK to confirm the setting. <p>⇒ The display changes automatically to the next commissioning step.</p>										
	<p>Specify the motor cooling method:</p> <ul style="list-style-type: none"> 0: Self-ventilated - with fan on the motor shaft (factory setting) 1: Forced ventilation - with a separately driven fan 2: Liquid cooling 128: No fan 										
	<ol style="list-style-type: none"> Press OK to change the parameter. Use keys ▲ and ▼ in order to select the required control mode from the list. V/f control with square characteristic (VF QUAD) is the normal choice for pump, fan and compressor applications. Press OK to confirm your selection. <p>⇒ The next step in the commissioning process is then displayed automatically.</p>										
	<p>Use macros to select predefined input and output circuits:</p> <ul style="list-style-type: none"> 12: Enable via DI0, setpoint via AI0 (factory setting) 109: Enable and setpoint via Modbus 110: Enable and setpoint via BACnet <p>You can find further macros and applications in the "Installation / Commissioning" guide.</p>										
	<p>Define the minimum and maximum frequencies at which the motor will operate when it is enabled.</p>										
	<p>With respect to the minimum frequency selected, the analog input can be scaled accordingly in this step, e.g. 20 % (0 V input signal then corresponds to 20 %, or 10 Hz).</p>										
	<p>Enter the ramp-up and ramp-down times in seconds. Press OK in order to select the parameter and keys ▲ and ▼ to change the value.</p> <table border="1" data-bbox="703 1742 1487 1953"> <thead> <tr> <th>Rating</th> <th>Recommended ramp time for fans</th> </tr> </thead> <tbody> <tr> <td>0.37 – 3 kW</td> <td>30s</td> </tr> <tr> <td>4 – 15 kW</td> <td>60s</td> </tr> <tr> <td>18.5 – 30 kW</td> <td>90s</td> </tr> <tr> <td>37 – 90 kW</td> <td>120s</td> </tr> </tbody> </table>	Rating	Recommended ramp time for fans	0.37 – 3 kW	30s	4 – 15 kW	60s	18.5 – 30 kW	90s	37 – 90 kW	120s
Rating	Recommended ramp time for fans										
0.37 – 3 kW	30s										
4 – 15 kW	60s										
18.5 – 30 kW	90s										
37 – 90 kW	120s										



	<p>You can specify an alternative ramp-down time if necessary.</p>
	<p>Activates the motor data identification process. A motor ID process is compulsory if the CTRL MODE (P1300) has been set to 20 (Sensorless Vector Control). Motor data identification is initiated when the drive is first enabled following basic commissioning. The result of the motor data identification process must be copied from RAM to ROM! (Options→RAM to ROM)</p>
	<p>Confirm that the basic commissioning has been completed. The variable speed drive will compute the motor data.</p> <ol style="list-style-type: none"> 1. Press OK to change the parameter. 2. Use keys ▲ and ▼ to select "YES". 3. Press OK to confirm your selection and complete the basic commissioning process.

Table 11: Commissioning with BOP-2

Commissioning with IOP-2-BT



For further information on technical data, commissioning and operation of the G120P with IOP-2-BT, see A5E39549448B, [SIOS Entry-ID: 109781592](#).

To enter the data for the Quick Setup with the IOP-2-BT, proceed as follows:

Quick Setup



CAUTION

Requirements prior to using the Quick Setup

- The user must be fully conversant with all safety instructions as detailed in the "Fundamental Safety Instructions" section of the Operating Instructions for your converter.
- The converter must be installed and checked as per the relevant instructions in the "Installation" sections of the converter Operating Instructions.
- Macro source selection: During the Quick Setup process, the user will be presented with a list of preset macros that determine the configuration of converter. Every Control Unit Operating Instructions contain a list of the macros that are specific for that particular Control Unit and show the wiring configurations for each macro. For further information, see the relevant Operating Instructions.
- The information required to be input into the Quick Setup process can be found on the motor rating label, an example of which is included in the Operating Instructions for your converter.
- If the motor is to operate with the "87 Hz characteristic"; You need to use the "Advanced Setup" process and you need to connect the motor in Delta (Δ), this is shown in the "Installation" section of the Operating Instructions for your converter.

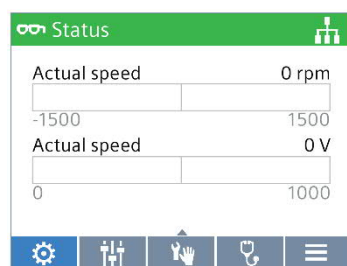

Select Setup

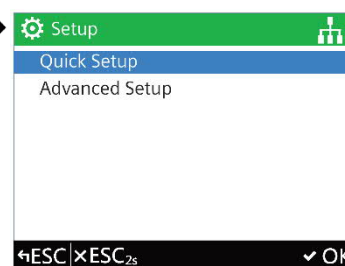

Select Quick Setup

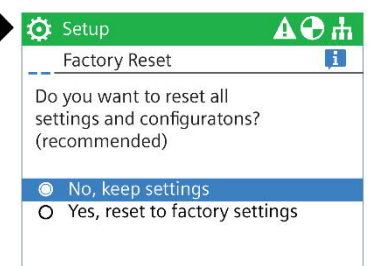

Select Factory Reset (yes or no)

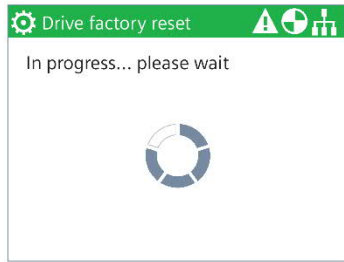

Factory Reset begins

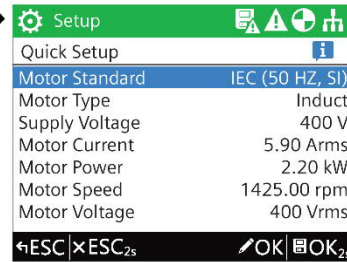

Select Motor Standard

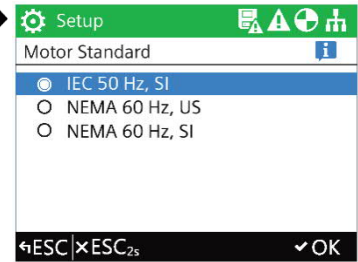

Select mains frequency and units

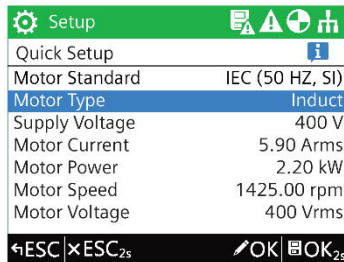

Select Motor Type

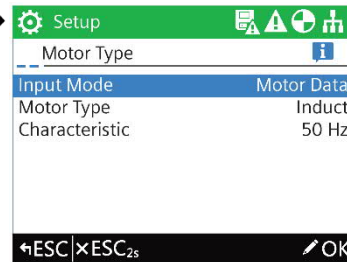

Select Input Mode

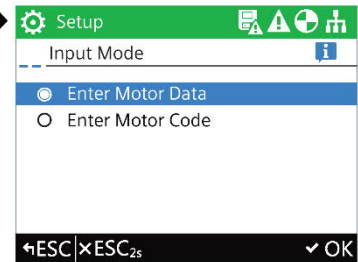

Enter Motor Data or Motor Code

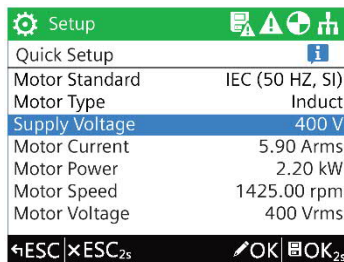

Select Supply Voltage

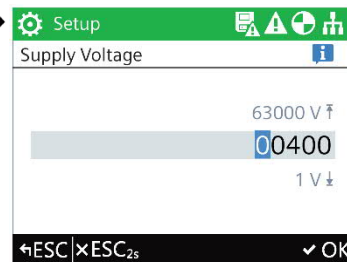

Enter Supply Voltage from rating label

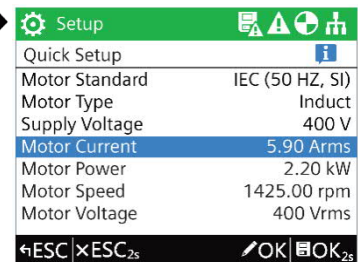

Select Motor Current



Enter Motor Current from rating label

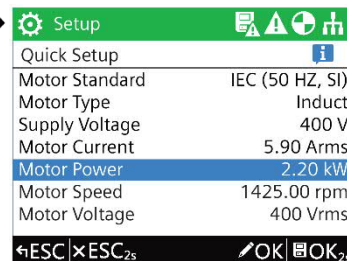

Select Motor Power



Enter Motor Power from rating label

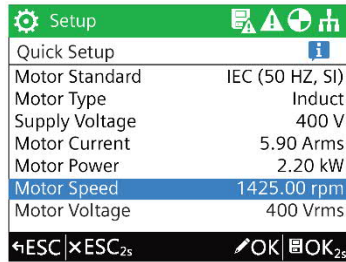

Select Motor Speed



Enter Motor Speed from rating label

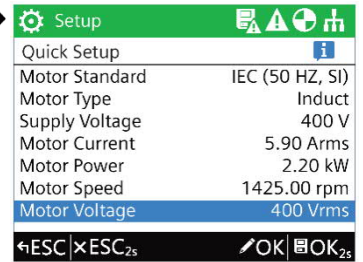

Select Motor Voltage

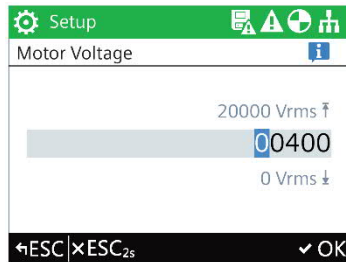

Enter Motor Voltage from rating label

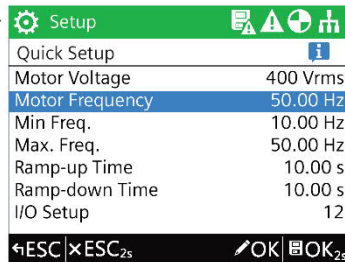

Select Motor Frequency

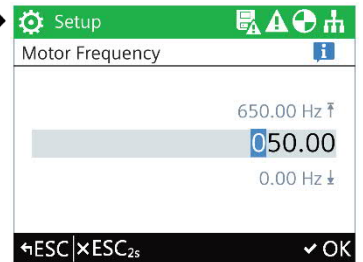

Enter Motor Frequency

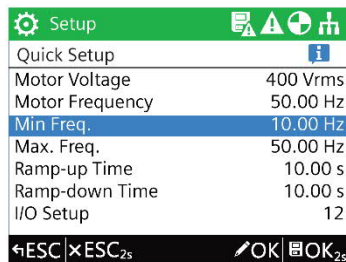

Select Min. Freq.

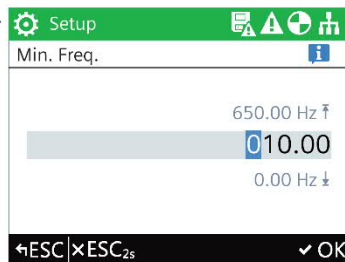

Enter the required Min. Freq.

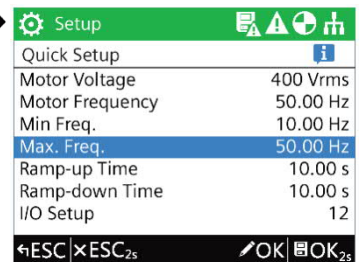

Select Max. Freq.

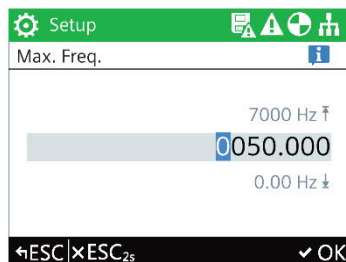

Enter the required Max. Freq.

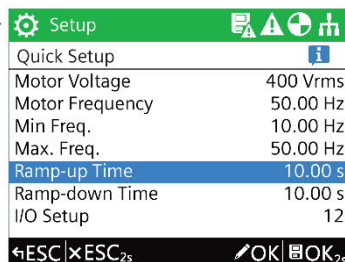

Select Ramp-up Time



Enter required Ramp-up Time

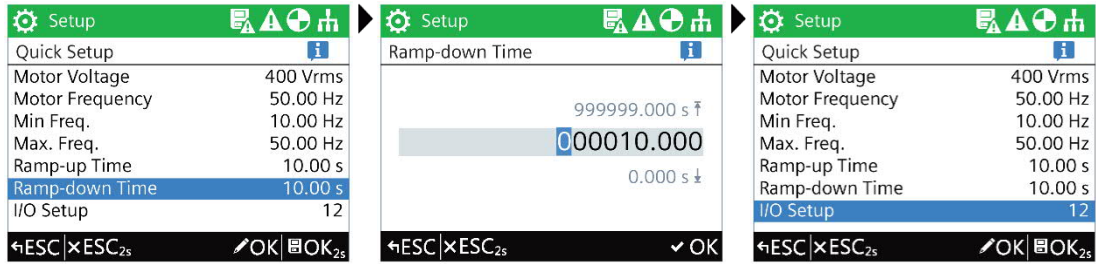

Select Ramp-down Time

Enter required Ramp-down Time

Select I/O Setup

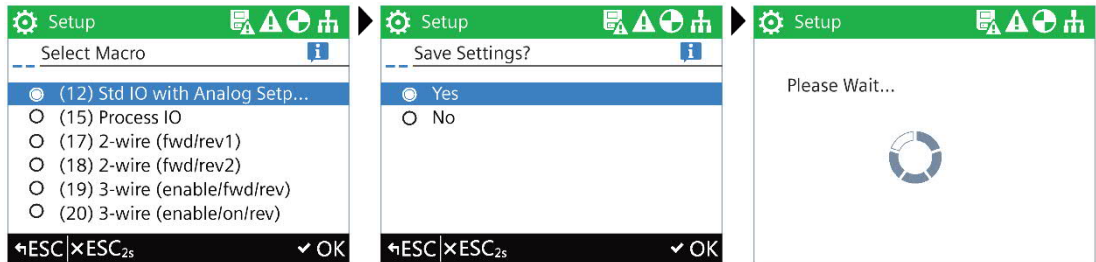

Select the required Macro

Save the Settings

Saving Settings in progress

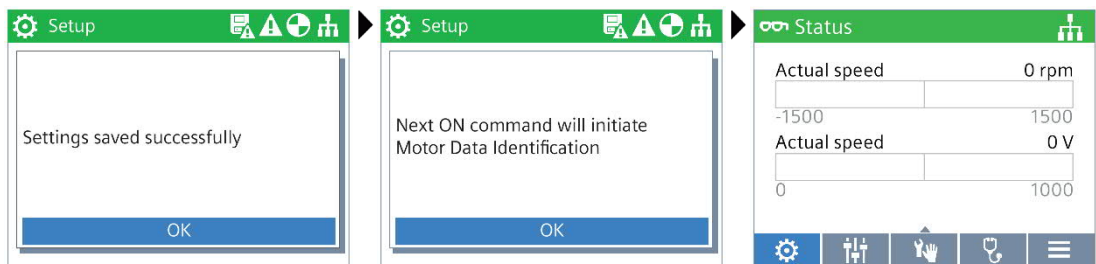

Settings have been saved

Motor ID ran on next ON command

Setup up completed

Commissioning with SAM



For further information on technical data, commissioning and operation of the G120P with SAM, see [SIOS Entry-ID: 109781592](#).

You can open the quick setup Web page by selecting the quick setup icon from either the home page or the navigation sidebar to do the quick commissioning of the converter. The quick setup icon may vary depending on the connected converters. For more information, see operating instructions „SINAMICS G120 Smart Access“ A5E43332487, [SIOS Entry-ID:109792113](#), Chapter „Overview of the Web pages“.

Classic quick setup



The classic quick setup Web page allows you to set the following data for the connected converter:

- Application class
- Motor data
- I/O-configuration
- Important parameters
- Technological application
- Motor identification

Expanded page for classic quick setup

When you see the Expand sidebar on the far left of the classic quick setup page, click the sidebar and an expanded quick setup page opens. You can do the following on this page:

- View the status of individual quick setup steps based on the symbols given below:

	Completed step
	Current step
	To-be-completed step

- Go back to a completed step. Once you open a completed step, all the changes done in subsequent steps become invalid and require new settings.

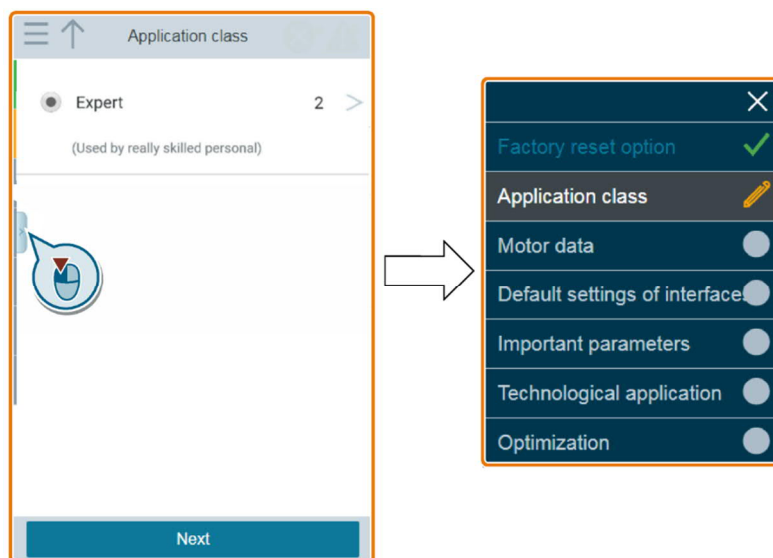

Operating sequence

- Open the classic quick setup Web page by selecting the quick setup icon from either the home page or the navigation sidebar.
- Reset to factory settings (recommended) or modify existing settings.



3. Select an application class according to the particular converter connected. If required, click relevant application class to expand the detailed description.

If "Expert" is selected, you can select your control mode of the converter.

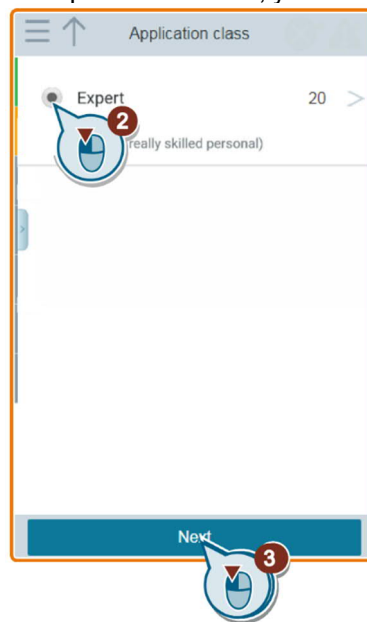

4. Set the required motor data.

For Siemens motors, enter only the motor data as shown in ④ and the SINAMICS G120 Smart Access will automatically identify the rest of the motor data.

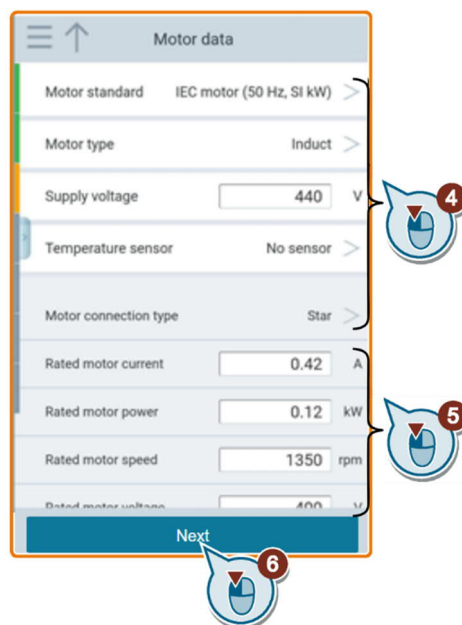

5. Select the factory interface settings for the converter based on your particular application. Note that the factory interface settings vary depending on the connected converter.

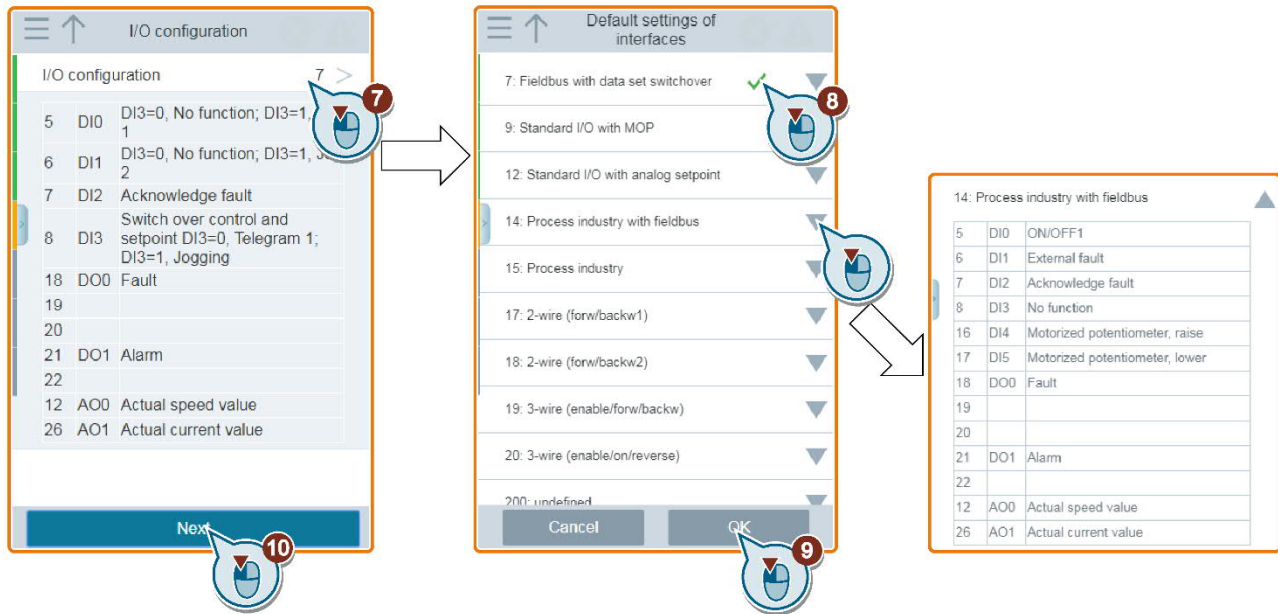

6. Set the following parameters based on your particular application.

- Minimum speed - factory setting 0 [rpm]

The minimum speed is the lowest speed of the motor independent of the speed setpoint.

- Maximum speed - factory setting 1500 [rpm]

The converter limits the motor speed to the maximum speed.

- The ramp-up and ramp-down times define the maximum motor acceleration when the speed setpoint changes. The ramp-up and ramp-down times are derived from the time between motor standstill and the maximum speed, or between the maximum speed and motor standstill.

- OFF3 ramp-down time sets the ramp-down time from the maximum speed down to zero speed for the OFF3 command.

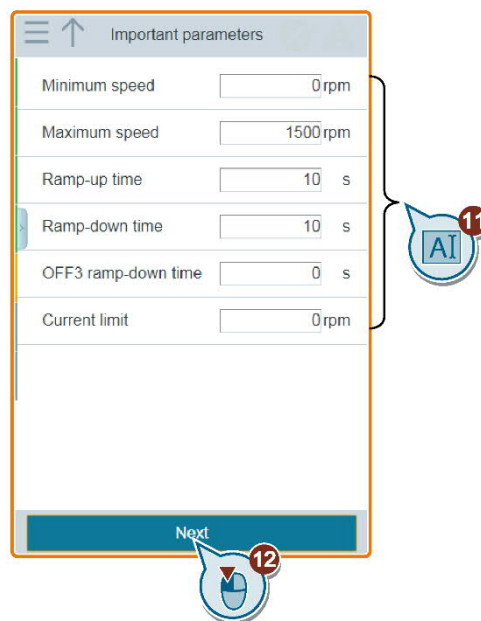

7. Select the desired technological application. Depending on the selected application class, the available technological applications may vary.

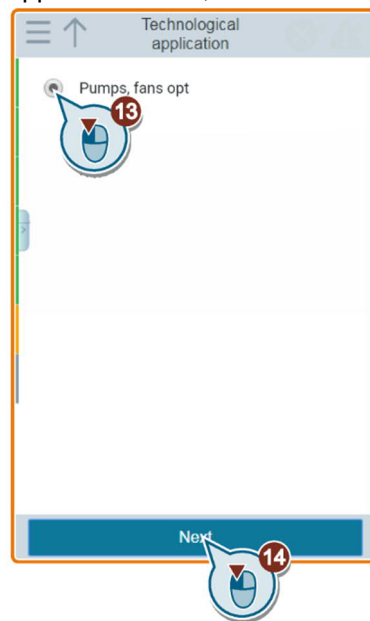

8. Select the method which the converter uses to measure the data of the connected motor.

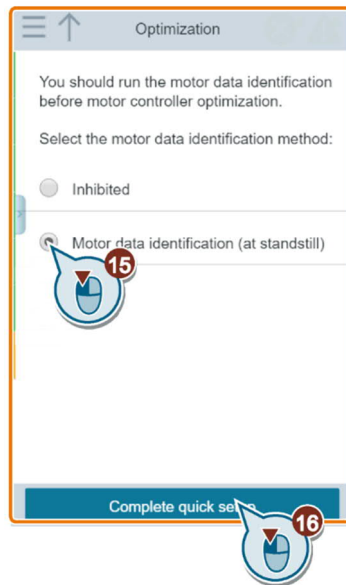

Depending on the selected application class and technological application, the available methods for motor identification may vary:

- Inhibited: P1900 = 0
- Motor data identification and speed controller optimization: P1900 = 1
- Motor identification at standstill: P1900 = 2

If you choose to identify the motor data, go to the JOG page after you have finished classic quick setup. For information about motor identification, see operating instructions „SINAMICS G120 Smart Access“ A5E43332487, [SIOS Entry-ID: 109792113](#), Chapter „JOG“.

9. Complete quick setup. You can select to go to the JOG page immediately or later.

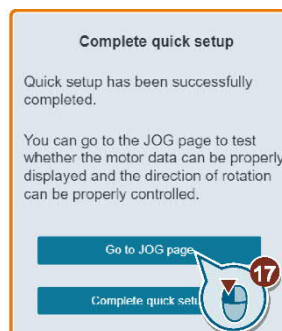

6.5 Configuring communication

- ▷ You are currently performing, or have already completed, basic commissioning.
1. When you reach the appropriate stage of basic commissioning, select the macro (MacPar) 108 (USS fieldbus), 109 (Modbus), 110 (BACnet) or 114 (P1 fieldbus).
 2. If the basic commissioning has already been performed, change the value manually, for example:
P0010 = 1 (parameter filter quick commissioning)
P0015 = 108 (macro 108)
P0010 = 0 (parameter filter ready)
 3. If the communication function is only to monitor the drive, but not to control it, proceed as follows:
 4. Basic commissioning with macro 108, 109, 110 or 114.
 5. P0010 = 1 (parameter filter quick commissioning)
P0015 = 12 (macro 12, control via digital input and analog setpoint)
P0010 = 0 (parameter filter ready)



The "Unit switchover" function is not permissible with this system.

RS485 interface



For information about integration in Desigo, see Engineering Manual TX G120P (document ID: CM110576).

Interfacing to a network

1. Connect the variable speed drive to your fieldbus via the RS485 interface. This connector has short-circuit proof, isolated pins.
2. Connect the bus terminating resistor for the first and last stations.

When the bus is operating, the first and last bus station must be continuously connected to the supply. The maximum cable length is 1200 m (3300 ft).



NOTICE

Supply the Control Unit with 24 V DC via terminals 31 and 32 to enable communication to continue to take place with the controller when the line voltage is switched off.

See also Chapter CU230P-2-BT Control Unit [→ 22].

Setting the address

1. Set the variable speed drive's fieldbus address either using the DIP switch on the Control Unit or via parameter p2021.
2. Please refer to Chapter CU230P-2-BT Control Unit [→ 22] for the position and setting of the DIP switch. If you have set a valid address using the DIP switch, this address always remains valid and p2021 cannot be changed.
⇒ If you set all DIP switches to "OFF" (0), then p2021 defines the address.



A bus address, baud rate or protocol selection that has been changed only becomes effective once the variable speed drive has been switched off and back on again.

Restart the variable speed drive after changing the bus address.

USS protocol

Parameter	Description		
p0015	Select value 108 "USS fieldbus" during basic commissioning.		
p2020	Value	Baud rate	
	4	2400	
	5	4800	
	6	9600	
	7	19200	
	8	38400	
	9	57600	
	10	76800	
	11	93750	
	12	115200	
	13	187500	
	p2021	Valid USS addresses: 1...30 Invalid USS addresses: 0.31...127	
	p2022	Fieldbus interface USS PZD number <ul style="list-style-type: none"> • Setting the number of 16-bit words in the PZD part of the USS telegram 	
p2023	Fieldbus interface USS PKW number <ul style="list-style-type: none"> • Setting the number of 16-bit words in the PKW part of the USS telegram 		
	0	0 Wörter	
	3	3 Wörter	
	4	4 Wörter	
	127	Variable Anzahl Wörter	

Modbus RTU protocol

Parameter	Description
p0015	Select value 109 "Modbus RTU" during basic commissioning.
p2021	Valid Modbus RTU addresses: 1...247 Invalid Modbus RTU address: 0
p2020	Fieldbus baud rate <ul style="list-style-type: none"> Baud rates from 4800 bps to 187500 bps can be set for communication. Factory setting: 19200 bps
p2024	Modbus timing <ul style="list-style-type: none"> Index 0: Maximum slave telegram processing time Maximum response time from the slave to the master. Index 1: Character delay time Maximum permissible delay time between the individual characters in the Modbus frame (Modbus standard processing time for 1.5 bytes). Index2: Inter-telegram delay Maximum permissible delay time between Modbus telegrams (Modbus standard processing time for 3.5 bytes).
p2029	Fieldbus error statistics <ul style="list-style-type: none"> Displays receive errors on the fieldbus interface.
p2031	Modbus parity
p2040	Process data monitoring time [ms] <ul style="list-style-type: none"> Setting the time to monitor the process data received. If no process data is received within this time, an appropriate message is output Factory setting: 10000 ms The setting 0 ms deactivates the monitoring function.

BACnet MS/TP

Parameter	Description
p0015	Select value 110 "BACnet MSTP" during basic commissioning.
p2021	Valid BACnet addresses: 1...127
p2020	Fieldbus baud rate <ul style="list-style-type: none"> 6: 9600 bps (factory setting) 7: 19200 bps 8: 38400 bps 10: 76800 bps
p2024	Processing times <ul style="list-style-type: none"> [0]: 0ms ... 10000 ms, maximum processing time (APDU timeout) Factory setting: 1000 ms [1...2]: No significance for BACnet

Parameter	Description
p2025	<p>BACnet communication parameter The device object ID (p2025[0]) must be greater than 1 in the case of firmware < 4.6.</p> <ul style="list-style-type: none"> [0]: 0...4194303, device object instance number Factory setting: 1 [1]: 1...10, maximum info frames Factory setting: 1 For optimum performance, this value should be set to 10. [2]: 0...99, number of APDU retries after fault telegrams Factory setting: 3 [3]: 1...127, maximum master address Factory setting: 127 <p>To optimize performance, this value should not be greater than the number of devices on the bus (including the master).</p>
p2026	<p>Setting the COV increment (COV = change of values)</p> <ul style="list-style-type: none"> Here you can define a setting for the value changes for which an UnConfirmedCOVNotification or ConfirmedCOVNotificationresult is sent. The factory setting 0.100 means that an UnConfirmedCOVNotification or ConfirmedCOVNotification is sent if the value being considered (e.g. for a control range from 0 ... 10 V) changes by an absolute value of ≥ 0.1. Of course this only applies if previously a SubscribeCOV service was activated for the particular object instance. You can also set the COV increment using the object property "COVIncrement" of the particular analog input. 0...4194303.000 Factory setting: 0.100 [0]: COV increment of object instance "Analog Input 0" [1]: COV increment of object instance "Analog Input 1" [2]: COV increment of object instance "Analog Input 10" [3]: COV increment of object instance "Analog Input 11"
P2027	BACnet language setting
p2040	<p>Process data monitoring time [ms]</p> <ul style="list-style-type: none"> Setting the time to monitor the process data received. If no process data is received within this time, an appropriate message is output Factory setting: 10000 ms The factory setting for communication with BACnet is possibly too low and must be increased. Adapt the value to the requirements and properties of your particular plant or system. The setting 0 ms deactivates the monitoring function.



The configuration workload can be reduced by leaving out values which are not required. In this case, the appropriate parameters must be set manually. For more information, refer to table "Fieldbus control word".

P1 FLN

Parameter	Value	Description
p0015	114	Select value 114 "P1 communication" during basic commissioning.
p2020	5	Baud rate 4800 bps, alternative setting option for P1: p2020 = 6 (9600 bps)
p2021	1 ... 99	Slave address (factory setting = 99)



The "Point numbers" defined in the device for communication via P1 can be found in the Operating Instructions for the Control Unit (A5E34257946B).

Fieldbus control word

r2090	BACnet	Function	Parameter	Condition for motor start
Bit 0	BV20	Command execution	p0840	1
Bit 1	BV27	No OFF2	p0844	1
Bit 2	BV28	No OFF3	p0848	1
Bit 3	BV26	Enable operation	p0852	1
Bit 4	BV26	Permit RFG enable	p1140	1
Bit 5	BV26	Enable RFG	p1141	1
Bit 6	BV26	Enable setpoint	p1142	1
Bit 7	BV22	Acknowledge faults	p2103	-
Bit 8	N/A	Reserved	-	-
Bit 9	N/A	Reserved	-	-
Bit 10	BV93	Master control by PLC	p0854	1
Bit 11	BV21	Inversion direction	p1113	-
Bit 12	N/A	Reserved	-	-
Bit 13	N/A	MOP setpoint higher	p1035	0
Bit 14	N/A	MOP setpoint lower	p1036	0
Bit 15	N/A	Reserved	-	-

6.6 Additional settings**6.6.1 Restoring parameters to factory settings**

!	NOTICE
	<p>Risk of data loss!</p> <p>When you reset parameters to the factory settings, all stored parameters and data will be lost. Once the device has been reset to its factory settings, it must be commissioned again.</p> <ul style="list-style-type: none"> • Make a copy of the working settings before you reset the variable speed drive to its factory settings.



The communication settings and the settings of the motor standard (IEC/NEMA) are retained after resetting.

Proceed as follows to reset the variable speed drive to its factory settings:

STARTER software

1. Go online with STARTER.

2. Click the  button.

IOP-2-BT

1. Select Options > Parameter settings > Reset drive to factory settings.
2. Confirm with OK.

BOP-2

1. Select Options > DRVRESET in the menu.
2. Confirm with OK.

6.6.2 Setting the PID controller

Setting the PID controller

If the PID controller is activated, the set ramp times are bypassed in p1120 and p1121 (applies only to FW < V4.7 SP3).

- Therefore, define the following settings for smoothing times, ramp times and controller.

Parameter	Setting	Function
p2200	1	Setting of the signal source for switching the technology controller on/off.
p2253	r2224	Technology controller setpoint <ul style="list-style-type: none"> • r755.0: Analog setpoint (AI0) • r2224: Technology controller fixed value • r2050.1: Setpoint fieldbus
p2257	30s *	Technology controller setpoint ramp-up time
p2258	30s *	Technology controller setpoint ramp-down time
p2264	r755.1	Technology controller actual value r755.1: Analog actual value (AI1)
p2265	10s *	Technology controller actual value filter time constant
p2267	120%	Technology controller upper limit actual value
p2268	-20%	Technology controller lower limit actual value
p2280	1	Technology controller proportional gain
p2285	30s *	Technology controller integral time
P2293	30s *	Technology controller ramp-up/ramp-down time
p2306	0	Technology controller fault-signal inversion (heating or cooling)
<p>* The time settings, such as "Technology controller integral action time" are dependent on the used frame size. For further information, refer to the Operating Instructions for the Control Unit (A5E34257946B).</p> <p>The recommended PID controller settings can be parameterized by means of a macro:</p> <ul style="list-style-type: none"> • P0010 = 1 • P0015 = 120 "PID settings for pumps or fans (only for optimization)" • P0010 = 0 		

6.6.3 Overview of parameters

Open the Parameters menu

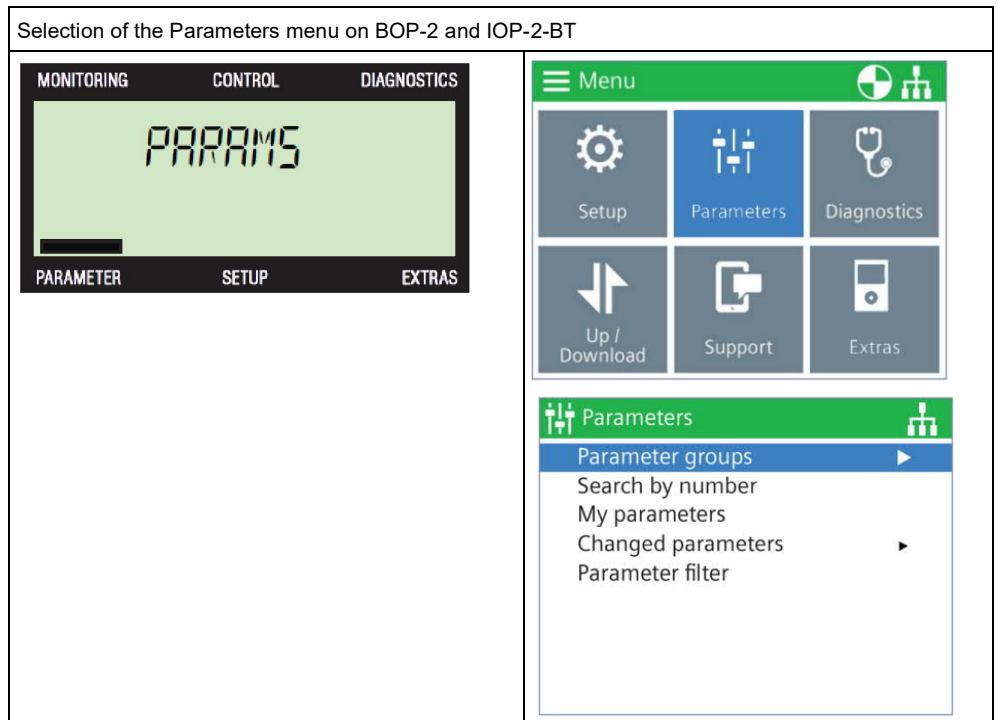

Table 12: Parameter selection

Overview of parameters



The table below contains only an excerpt from the parameter list. You can find a complete list of parameters in List Manual CU230P, [SIOS Entry-ID: 109782303](#).

Parameter	Factory settings	Function
p0601	0	Motor temperature sensor type: 0: No sensor 1: PTC warning & timer 2: KTY84 4: Bimetallic NC contact warning & timer 6: Pt 1000
p0730	r52.3	Digital output 0: Fault active
p0731	r52.7	Digital output 1: Alarm active
p0732	r52.2	Digital output 2: Operation enabled. Motor in operation.
p0748	000	Invert digital outputs (0 = do not invert, 1 = invert) Bit 0: DO 0 Bit 1: DO 1 Bit 2: DO 2
r0755[0..3]	-	Analog inputs, actual value in percent

Parameter	Factory settings	Function				
p0756 [0]	-	AI 0 (0-4)	0: Unipolar voltage input (0 V...10 V)			
p0756 [1]	-	AI 1 (0-4)	1: Unipolar voltage input monitored (2 V... 10 V)			
p0756 [2]	-	AI 2 (2-3, 6-8)	2: Unipolar current input (0 mA...20 mA)			
p0756 [3]	-	AI 3 (6-8)	3: Unipolar current input monitored (4 mA...20 mA)			
			4: Bipolar voltage input (-10 V...10 V)			
			6: LG-Ni1000 temperature sensor (-50 °C...150 °C)			
			7: PT1000 temperature sensor (-50...250 °C)			
			8: No sensor connected			
p0771[0]	-	AO 0	Important status signals:			
p0771[1]	-	AO 1	0: Analog output locked			
			21: Speed actual value			
			24: Output frequency, smoothed			
			25: Output voltage smoothed			
			26: DC link voltage, smoothed			
			27: Actual current value (smoothed absolute value)			
p0776[0, 1]	-	Analog outputs, type				
		0: Current output (0 mA...20 mA)				
		1: Voltage output (0 V...10 V)				
		2: Current output (4 mA...20 mA)				
p0840	r0722.0	ON/OFF1 signal source				
p0852	1	Enable operation Is used to let the motor coast to a standstill if the ON command is enabled. Example: P0852 = r0722.0.				
p1000	2	Speed setpoint selection 2 = Analog setpoint 3 = Fixed speed 6 = Fieldbus For further values, see the List Manual				
p1082	1500 rpm	Maximum motor speed in rpm				
		50Hz =	60Hz =	70Hz =	80Hz =	
		2-pole motor (rated speed approx. 2750 – 3000 rpm)	3000 rpm	3600 rpm	4200 rpm	4800 rpm
		4-pole motor (rated speed approx. 1250 – 1500 rpm)	1500 rpm	1800 rpm	2100 rpm	2400 rpm
		The reference speed (p2000) must be set to the same value.				
p1113	r722.1	Invert setpoint				
p1200	0	Flying restart selection: 0: Flying restart inactive 1: Flying restart always active (start in setpoint direction) 4: Flying restart always active (start only in setpoint direction)				

Parameter	Factory settings	Function
p1210	0	Automatic restart: 0: Disables automatic restart 1: Acknowledges all faults without restarting 4: Restart after power failure, without additional startup attempts 6: Restart after fault with additional startup attempts 14: Restart after power failure after manual acknowledgement 16: Restart after fault after manual acknowledgement 26: Acknowledging all faults and restarting for an ON command Recommended setting: 26 During the restart waiting time, the alarm A07321 appears at FW < 4.6.
p1213[0]	60s	Restart monitoring time: Set this value to 0s for FW < 4.6; otherwise the fault F07320 is output if there has been no enable.
p1300	2	Open-loop/closed-loop control operating mode: 0: V/f control with linear characteristic 1: V/f control with linear characteristic and FCC 2: V/f control with parabolic characteristic 4: V/f control with linear characteristic and ECO 7: V/f control for parabolic characteristic and ECO 20: Speed control (without encoder)
p1820	0	Change the direction of rotation of the motor: 0: Off 1: On
p1800	4 kHz	Pulse frequency
p1900	0	Motor data identification: 0: Disabled 1: Motor data identification at standstill and when the motor is rotating 2: Motor data identification at standstill 3: Motor data identification when the motor is rotating It is imperative that this is carried out when using SLVC (P1300 = 20).
p2000	1500 rpm	Reference speed relative to 100% setpoint, identical to P1082
p2103	r722.2	Acknowledge faults
p3880	0	ESM activation of the signal source via digital input
p3881	0	ESM setpoint source: 0: Last known setpoint (r1078 smoothed) 1: Fixed speed setpoint 15 (p1015) 2: Analog setpoint AI0 (r0755[0]) 3: Setpoint from the fieldbus 4: Setpoint from the technology controller 6: Enable OFF1 reaction 7: Enable OFF2 reaction
p8400	0	Time of real-time clock: [0] = Hours (0 ... 23) [1] = Minutes (0 ... 59) [2] = Seconds (0 ... 59)

Parameter	Factory settings	Function
p8401	1.1.1970	Date of real-time clock: [0] = Day (1 ... 31) [1] = Month (1 ... 12) [2] = Year (YYYY)

Scaling of analog input (example)

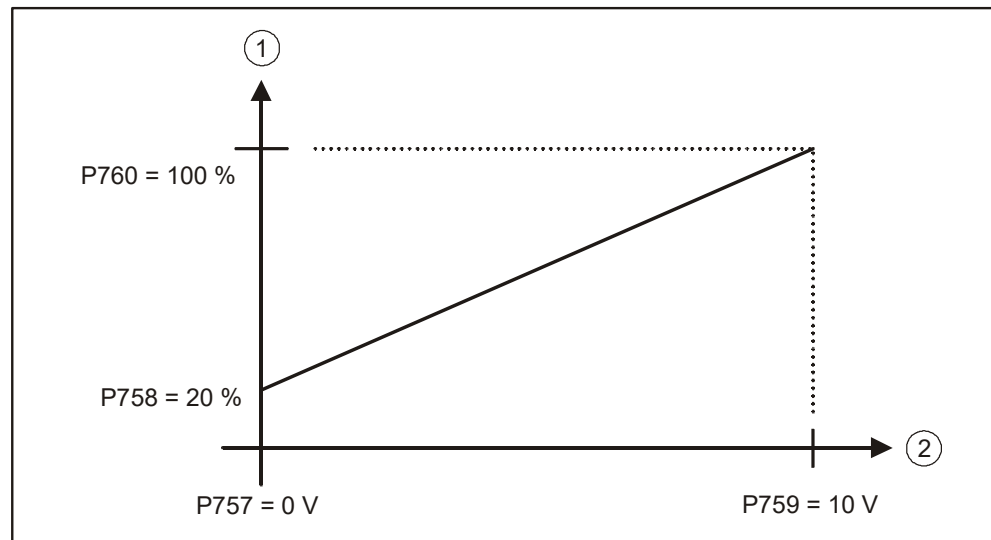

Figure 25: Scaling analog input

Item	Designation
1	Setpoint [%]
2	Analog input [V]

6.7 Backing up data (memory card)

SD cards up to 2GB are supported. Siemens memory cards provide other functions. For more information on supported memory cards, see chapter "Memory cards" in the manual CU230P-2, [SIOS Entry-ID: 109782866](#).

!	NOTICE
	Risk of data loss If the memory card already contains the settings of another variable speed drive, the device adopts those settings. Data may be lost. <ul style="list-style-type: none">• Use an empty memory card.

- ▷ You require an empty memory card for the following procedure.
1. Switch off the power supply of the variable speed drive.
 2. If the Control Unit is connected to a computer via a USB cable, the card is identified as a bulk storage device and its use is blocked. Remove the USB cable which has been inserted.
 3. Wait until the variable speed drive is in a completely no-voltage condition and no LED on the Control Unit is lit.
 4. Insert the empty memory card into the card slot on the Control Unit.
 5. Switch on the operating voltage of the drive.
 - ⇒ After the variable speed drive has been switched on, it copies the settings to the memory card.

7 Application examples

Basic commissioning (Carrying out basic commissioning [→ 55]) is a prerequisite for the implementation of the application examples. During basic commissioning, the applications below can be parameterized directly via the macro parameter p0015. If the applications have to be set subsequently, the device must be set to commissioning state.

Example: p0010 = 1 → p0015 = 101 → p0010 = 0

7.1 Factory settings

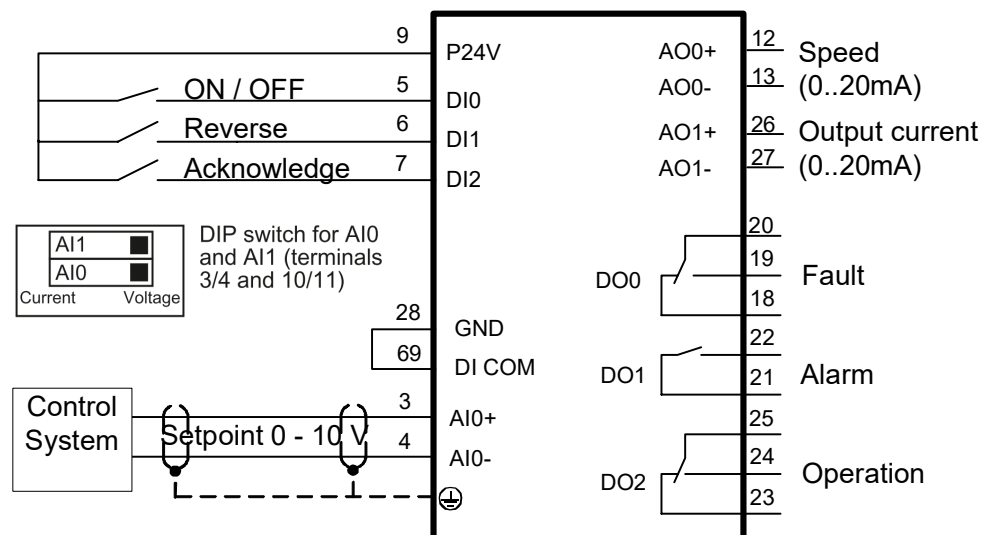

Figure 26: Terminal assignment in the factory settings (corresponds to MacPar15 = 12)

7.2 Universal application

- Macro 101 "Universal application"
- Setpoint via a 0...10 V signal
- Analog setpoint can be overridden with 3 fixed speeds
- Flying restart and automatic restart activated
- Essential service mode (in the event of fire) with a fixed setpoint
- Error message: Digital output 0
- Status display: Digital output 2

Notice:

In the case of the extended emergency mode, the customer can no longer lodge any claims for warranty. Extended emergency mode and the faults which arise during this mode are logged in a password-protected memory and can be read by the repair center.

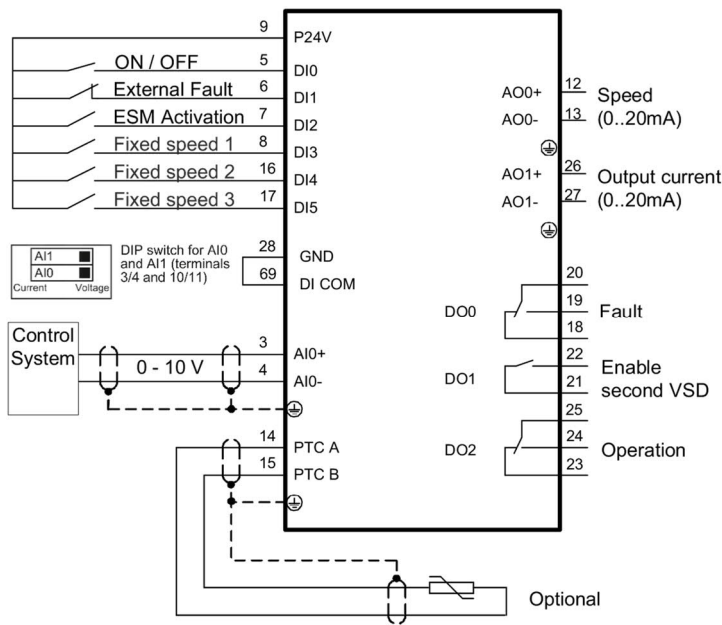

Parameter	Value	Description
p731	r52.2	Signal source for terminal DO 1
p756[0]	0	Unipolar voltage input (0...10 V)
p840[0]	r20047.0	ON / OFF (OFF1)
p1000[0]	32	Speed setpoint selection
p1001[0]	800 rpm	Fixed speed setpoint 1
p1002[0]	1000 rpm	Fixed speed setpoint 2
p1003[0]	1200 rpm	Fixed speed setpoint 3
p1015[0]	1500 rpm	Fixed speed setpoint 15
p1020[0]	r722.3	Fixed speed setpoint selection bit 0
p1021[0]	r722.4	Fixed speed setpoint selection bit 1
p1022[0]	r722.5	Fixed speed setpoint selection bit 2
p1071[0]	r20220	Main setpoint scaling
p1113[0]	0	Setpoint inversion
p1200[0]	1	Flying restart always active (start in setpoint direction)
p1210	26	Acknowledging all faults and restarting for an ON command
p2103[0]	0	Acknowledge faults
p2106[0]	r722.1	External fault
p3880	r722.2	ESM activation
p3881	1	ESM setpoint source: Fixed setpoint 15 (p1015)
p20046[0]	r722.0	OR input I0
p20046[1]	r1025.0	OR input I1
p20048	1	OR runtime group
p20218[0]	100%	NSW input X0
p20218[1]	0	NSW input X1
p20219	r1025.0	NSW switch position I
p20221	5	NSW runtime group

7.3 Pump pressure control

- Macro 103 "Pump pressure control"
- Differential pressure regulated by integrated PID controller
- Flying restart and automatic restart activated
- Error message: Digital output 0
- Status display: Digital output 2

When selecting this application using macro 103, the technological unit remains unchanged at [%]. If necessary, adapt the unit as described in the parameter list. Select the values depending on the used sensor.

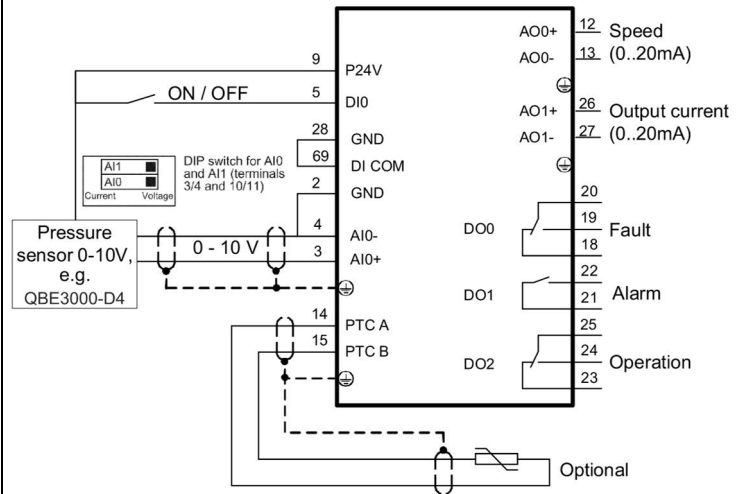

Parameter	Value	Description
p596	4	Reference variable of the technological unit
p0010	5	Parameter filter change, technological unit
p595	3	Selection of technological unit: bar
p0010	0	Parameter filter ready
p756[0]	0	Unipolar voltage input (0...10 V)
p0840	r722.0	ON / OFF (OFF1)
p1200[0]	1	Flying restart always active (start in setpoint direction)
p1210	26	Acknowledging all faults and restarting for an ON command
p2200[0]	1	Technology controller enable
p2201[0]	2 bar	Technology controller fixed value 1 Set the pressure setpoint to suit the application. This example uses a 0 to 4 bar sensor (e.g. QBE3000-D4).
p2253[0]	p2201	Technology controller setpoint 1
p2257	30s	Technology controller setpoint ramp-up time
p2258	30s	Technology controller setpoint ramp-down time
p2264[0]	r755[0]	Technology controller actual value
p2265	10 s	Technology controller actual value filter time constant
p2267	4.2 bar	Technology controller upper limit actual value
p2268	-1 bar	Technology controller lower limit actual value
p2293	30 s	Technology controller ramp-up/ramp-down time

7.4 Pressure controlled supply fan + ESM fixed speed

- Macro 105 "Pressure controlled supply fan + ESM fixed speed"
- Pressure in air duct regulated by integrated PID controller
- Flying restart and automatic restart activated
- Essential service mode (in the event of fire) with fixed frequency
- Error message: Digital output 0
- Status display: Digital output 2

When selecting this application using macro 105, the technological unit remains unchanged at [%]. If necessary, adapt the unit as described in the parameter list. Select the values depending on the used sensor.

Notice:

In the case of the extended emergency mode, the customer can no longer lodge any claims for warranty. Extended emergency mode and the faults which arise during this mode are logged in a password-protected memory and can be read by the repair center.

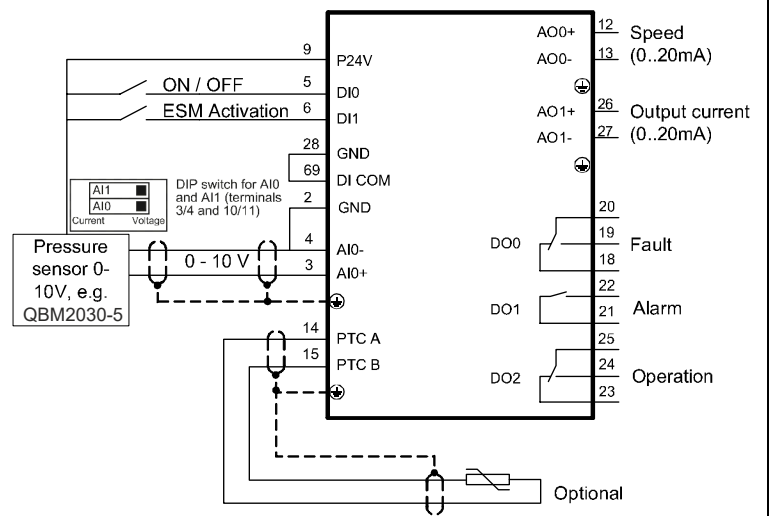

Parameter	Value	Description
p596	500	Reference variable of the technological unit
p0010	5	Parameter filter change, technological unit
p595	5	Selection of technological unit: Pa
p0010	0	Parameter filter ready
p756[0]	0	Unipolar voltage input (0...10 V)
p0840	r722.0	ON / OFF (OFF1)
p1015[0]	1350 rpm	Fixed speed setpoint 15
p1113[0]	0	Setpoint inversion
p1200[0]	1	Flying restart always active (start in setpoint direction)
p1210	26	Acknowledging all faults and restarting for an ON command
p2200[0]	1	Technology controller enable
p2201[0]	200 Pa	Technology controller fixed value 1
p2253[0]	p2201	Technology controller setpoint 1
p2257	30s	Technology controller setpoint ramp-up time
p2258	30s	Technology controller setpoint ramp-down time
p2264[0]	r755[0]	Technology controller actual value
p2265	10 s	Technology controller actual value filter time constant
p2267	600 Pa	Technology controller upper limit actual value
p2268	-50 Pa	Technology controller lower limit actual value
p2293	30 s	Technology controller ramp-up/ramp-down time
p3880	r722.1	ESM activation
p3881	1	ESM setpoint source: Fixed setpoint 15 (p1015)

7.5 Cooling tower fan (LG-Ni1000) + hibernation

- Macro 107 "Cooling tower LG-Ni1000 sensor + hibernation"
- Control of the cooling tower fan based on the temperature of the cooling water
- LG-Ni1000 temperature sensor on AI3
- Hibernation
- Flying restart and automatic restart activated
- Error message: Digital output 0
- Status display: Digital output 2

When selecting this application using macro 107, the technological unit remains unchanged at [%]. If necessary, adapt the unit as described in the parameter list. Select the values depending on the used sensor.

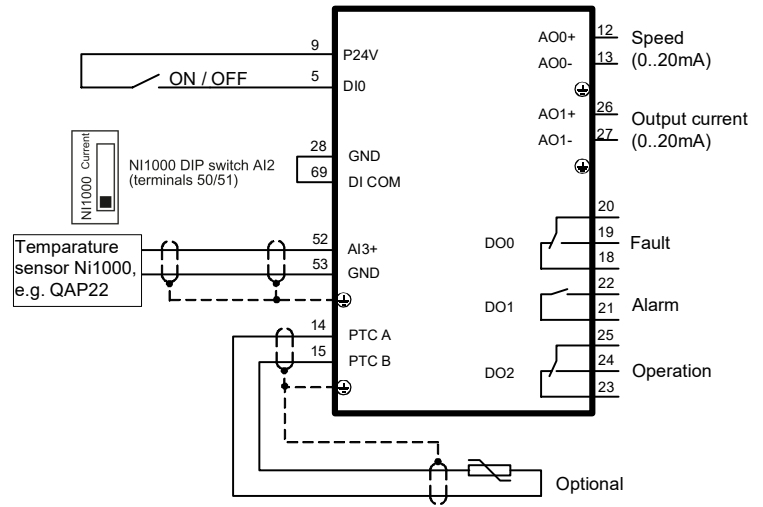

Parameter	Value	Description
p596	100	Reference variable of the technological unit
p0010	5	Parameter filter change, technological unit
p595	4	Selection of technological unit: °C
p0010	0	Parameter filter ready
p756[3]	6	LG-Ni1000 temperature sensor
p0840	r722.0	ON / OFF (OFF1)
p1200[0]	1	Flying restart always active (start in setpoint direction)
p1210	26	Acknowledging all faults and restarting for an ON command
p2200[0]	1	Technology controller enable
p2201[0]	26 °C	Technology controller fixed value 1
p2253[0]	p2201	Technology controller setpoint 1
p2257	30s	Technology controller setpoint ramp-up time
p2258	30s	Technology controller setpoint ramp-down time
p2264[0]	r755[3]	Technology controller actual value
p2265	10 s	Technology controller actual value filter time constant
p2267	100 °C	Technology controller upper limit actual value
p2268	-10 °C	Technology controller lower limit actual value
p2293	30 s	Technology controller ramp-up/ramp-down time
p2306	1	Technology controller fault-signal inversion
p2390[0]	50 rpm	Hibernation start speed
p2391[0]	60 s	Hibernation delay time
p2392	1 °C	Hibernation restart value with technology controller
p2398	1	Hibernation mode

7.6 Cooling tower fan (active sensor) + hibernation

- Macro 106 "Cooling tower active sensor + hibernation"
- Control of the cooling tower fan based on the temperature of the cooling water
- Temperature sensor 0...10 V on AI0
- Hibernation
- Flying restart and automatic restart activated
- Error message: Digital output 0
- Status display: Digital output 2

When selecting this application using macro 106, the technological unit remains unchanged at [%]. If necessary, adapt the unit as described in the parameter list. Select the values depending on the used sensor.

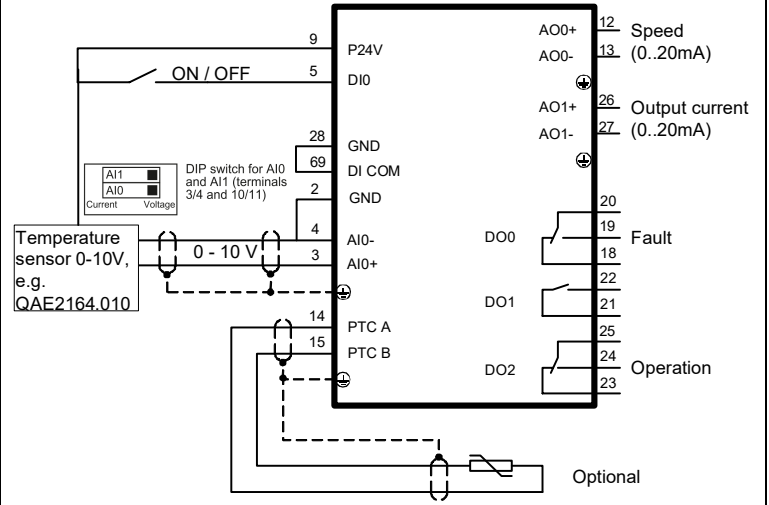

Parameter	Value	Description
p596	100	Reference variable of the technological unit
p0010	5	Parameter filter change, technological unit
p595	4	Selection of technological unit: °C
p0010	0	Parameter filter ready
p756[0]	0	Unipolar voltage input (0 V...10 V)
p0840	r722.0	ON / OFF (OFF1)
p1200[0]	1	Flying restart always active (start in setpoint direction)
p1210	26	Acknowledging all faults and restarting for an ON command
p2200[0]	1	Technology controller enable
p2201[0]	26 °C	Technology controller fixed value 1
p2253[0]	p2201	Technology controller setpoint 1
p2257	30s	Technology controller setpoint ramp-up time
p2258	30s	Technology controller setpoint ramp-down time
p2264[0]	r755[0]	Technology controller actual value
p2265	10 s	Technology controller actual value filter time constant
p2267	110 °C	Technology controller upper limit actual value
p2268	-10 °C	Technology controller lower limit actual value
p2293	30 s	Technology controller ramp-up/ramp-down time
p2306	1	Technology controller fault-signal inversion
p2390[0]	50 rpm	Hibernation start speed
p2391[0]	60 s	Hibernation delay time
p2392	1 °C	Hibernation restart value with technology controller
p2398	1	Hibernation mode

7.7 Stairwell pressurization (ESM)

- Macro 104 "ESM stairwell pressurization"
- Central fire alarm system starts the fan
- Essential service mode (in the event of fire) with pressurization, e.g., in a stairwell, in order to keep escape routes clear
- Flying restart and automatic restart activated
- Error message: Digital output 0
- Status display: Digital output 2

When selecting this application using macro 104, the technological unit remains unchanged at [%]. If necessary, adapt the unit as described in the parameter list. Select the values depending on the used sensor.

Notice:

In the case of the extended emergency mode, the customer can no longer lodge any claims for warranty. Extended emergency mode and the faults which arise during this mode are logged in a password-protected memory and can be read by the repair center.

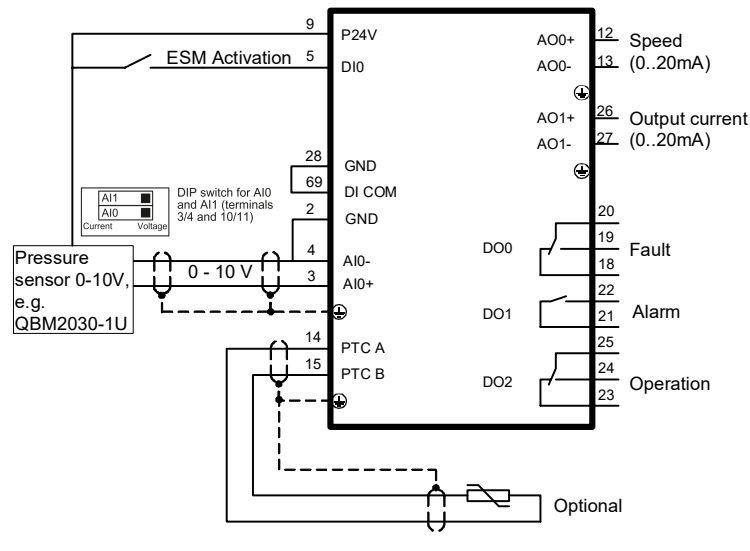

Parameter	Value	Description
p596	100	Reference variable of the technological unit
p0010	5	Parameter filter change, technological unit
p595	5	Selection of technological unit: Pa
p0010	0	Parameter filter ready
p1113[0]	0	Setpoint inversion
p1200[0]	1	Flying restart always active (start in setpoint direction)
p1210	26	Acknowledging all faults and restarting for an ON command
p2200[0]	1	Technology controller enable
p2201[0]	40 Pa	Technology controller fixed value 1
p2253[0]	p2201	Technology controller setpoint 1
p2264[0]	r755[0]	Technology controller actual value
p2267	120 Pa	Technology controller upper limit actual value
p2268	-10 Pa	Technology controller lower limit actual value
p3880	r722.0	ESM activation
p3881	4	ESM setpoint from the technology controller
p3884	p2201	ESM technology controller setpoint Fixed setpoint

7.8 Fixed setpoints

- Macro 111 "Fixed setpoints"
- Release and selection of 4 fixed speeds via digital inputs 0 to 4
- Error message: Digital output 0
- Status display: Digital output 2
- If there are several inputs active simultaneously, the setpoints are added. Combined with three inputs, there are six different speed levels available. The drive starts when one of the inputs is in ON position.

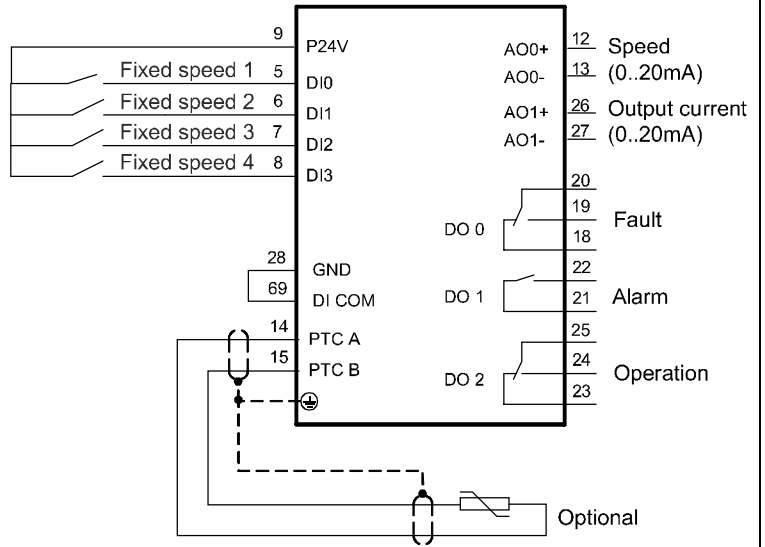

Parameter	Value	Description
p840[0]	r1025.0	ON / OFF (OFF1)
p1000[0]	3	Speed setpoint selection: Fixed speed
p1001[0]	300 rpm	Fixed speed setpoint 1
p1002[0]	600 rpm	Fixed speed setpoint 2
p1003[0]	900 rpm	Fixed speed setpoint 3
p1004[0]	1200 rpm	Fixed speed setpoint 4
p1020[0]	r722.0	BI: Fixed speed setpoint selection bit 0
p1021[0]	r722.1	BI: Fixed speed setpoint selection bit 1
p1022[0]	r722.2	BI: Fixed speed setpoint selection bit 2
p1023[0]	r722.3	BI: Fixed speed setpoint selection bit 3
p1113[0]	0	BI: Setpoint inversion
p1200[0]	1	Flying restart always active (start in setpoint direction)
p1210	26	Acknowledging all faults and restarting for an ON command
p2103[0]	0	BI: 1. Acknowledge faults

7.9 CO2 sensor, 2 PID setpoints

- Macro 112 "CO2 sensor, 2 PID setpoints"
- ON/OFF and PID setpoint selection via DI0 or DI2
- Set the fixed setpoint (50 % corresponding to the CO2 equivalent 1000 ppm)
- External alarm at DI1. The fan is stopped.
- Error message: Digital output 0
- Status display: Digital output 2
- If DI0 and DI2 are active simultaneously, the setpoints are added. The drive starts when one of the inputs is in ON position.

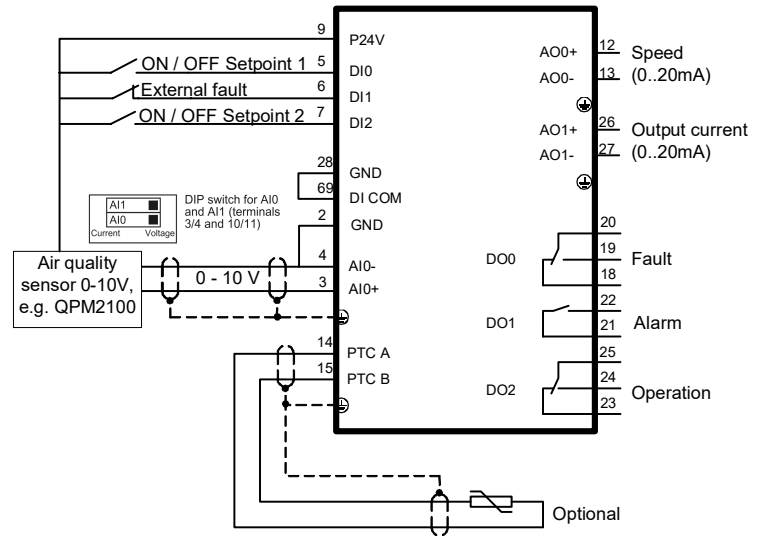

Parameter	Value	Description
p756[0]	0	Unipolar voltage input (0...10 V)
p840[0]	r2225.0	ON / OFF (OFF1)
p1113[0]	0	Setpoint inversion
p2103[0]	0	BI: 1. Acknowledge faults
p2106[0]	r722.1	External fault
p2200[0]	1	Technology controller enable
p2201[0]	50	Technology controller fixed value 1
p2203[0]	10	Technology controller fixed value 3
p2220[0]	r722.0	BI: Technology controller fixed value selection bit 0
p2222[0]	r722.2	BI: Technology controller fixed value selection bit 2
p2253[0]	r2224	Technology controller setpoint 1
p2264[0]	r755[0]	Technology controller actual value
p2267	120%	Technology controller upper limit actual value
p2268	-10%	Technology controller lower limit actual value
p2306	1	Technology controller fault-signal inversion

7.10 Temperature-dependent pressure setpoint

- Macro 113 "Temperature-dependent pressure setpoint"
- Pressure control setpoint dependent on outside temperature and limited between 20% and 50%

- LG-Ni1000 temperature sensor on AI2
- Pressure sensor 0...10 V on AI0
- Flying restart and automatic restart activated
- Error message: Digital output 0
- Status display: Digital output 2

Parameter	Value	Description
p756[2]	6	AI2: LG-Ni1000 temperature sensor
p757[2]	-20 °C	AI2 characteristic x1
p758[2]	20 %	AI2 characteristic y1
p759[2]	5 °C	AI2 characteristic x2
p760[2]	50 %	AI2 characteristic y2
p840[0]	r722.0	ON / OFF (OFF1)
p1200[0]	1	Flying restart always active (start in setpoint direction)
p1210	26	Acknowledging all faults and restarting for an ON command
p2200[0]	1	Technology controller enable
p2253[0]	r20231	Technology controller setpoint
p2257	30 s	Technology controller setpoint ramp-up time
p2258	30 s	Technology controller setpoint ramp-down time
p2264[0]	r755[0]	Technology controller actual value from AI0
p2265	10 s	Technology controller actual value filter time constant
p2267	120 %	Technology controller upper limit actual value
p2268	-10 %	Technology controller lower limit actual value
p2293	30 s	Technology controller ramp-up/ramp-down time
p20228	r755[2]	Setpoint limiting
p20229	0.5	Upper limit setpoint limiting 50%
p20230	0.2	Lower limit setpoint limiting 20%
p20234	5	Runtime group setpoint limiting

7.11 Fan with belt monitoring function

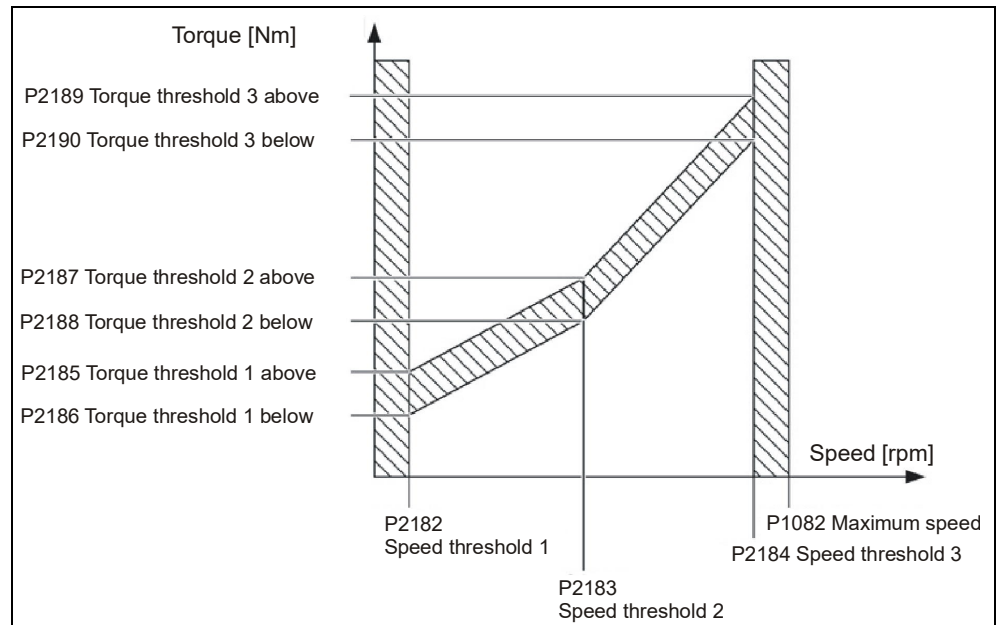

Accelerate the drive up to the three speed thresholds in MANUAL operation and read the actual torque from parameter r0031. Then set the torque thresholds according to the torque readings - 20% safety margin.

Parameter	Value	Description
P2181	4	Load monitoring response: F07923 if torque too low
P2182	300 rpm	Load monitoring, speed threshold 1
P2183	900 rpm	Load monitoring, speed threshold 2
P2184	1500 rpm	Load monitoring, speed threshold 3
P2186	Read r0031 in manual operation	Torque threshold 1 lower
P2188		Torque threshold 2 lower
P2190		Torque threshold 3 lower
P2192	10 s	Load monitoring, delay time
P2193	1	Monitoring torque and load drop activated

7.12 Pressure-controlled pump with cascade

Parameter	Value	Description
p0730	r2379.0	Signal source for digital output 0: Control external motor 1 via DO 0
p0731	r2379.1	Signal source for digital output 1: Control external motor 2 via DO 1
p0732	r2379.2	Signal source for digital output 2: Control external motor 3 via DO 2
p756[0]	0	Unipolar voltage input (0...10 V)
p0840	r722.0	ON / OFF (OFF1)
p1200[0]	1	Flying restart always active (start in setpoint direction)
p1210	26	Acknowledging all faults and restarting for an ON command
p2200[0]	1	Technology controller enable
p2201[0]	50%	Technology controller fixed value 1 Set the pressure setpoint to suit the application. This example uses a 0 to 4 bar sensor (e.g. QBE3000-D4).
p2253[0]	p2201	Technology controller setpoint 1
p2257	30s	Technology controller setpoint ramp-up time
p2258	30s	Technology controller setpoint ramp-down time
p2264[0]	r755[0]	Technology controller actual value
p2265	10 s	Technology controller actual value filter time constant
p2267	120%	Technology controller upper limit actual value
p2268	-20%	Technology controller lower limit actual value
p2293	30 s	Technology controller ramp-up/ramp-down time
p2370	1	Activate closed-loop cascade control
p2371	4	Configuration and motor connection sequence: 3 motors with identical power output
p2372	1	Motor selection mode: When a motor is connected, the motor with the least operating hours is connected. When a motor is disconnected, the motor with the most operating hours is shut down.
p2373	20 %	Switch-in threshold
p2374	30 s	Delay time for connection of external motors
p2375	30 s	Delay time for disconnection of external motors
p2376	25 %	Overcontrol threshold

7.13 Fans in 87 Hz operation

Example for the following motor:

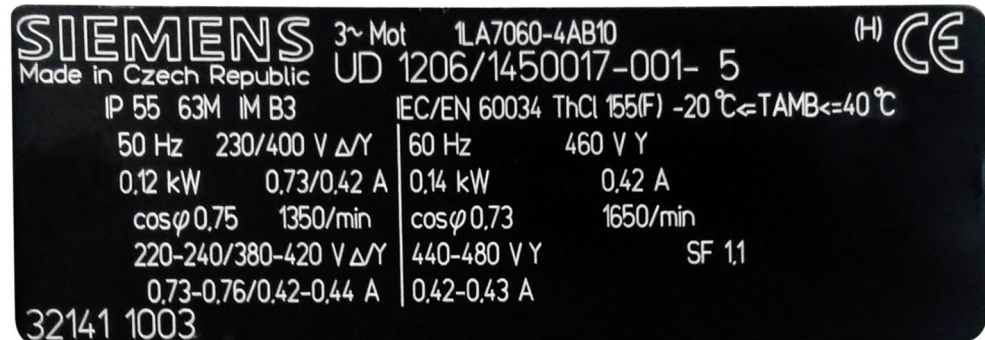

Figure 27: Example motor for 87 Hz operation

Carry out basic commissioning with 230V data

- IOP-2-BT/BOP-2: Select "87 Hz characteristic".
- Starter: Select connection type "Delta" and "87 Hz calculation".

Parameter	Value	Description
p0304	230 V	Rated motor voltage
p0305	0.73 A	Rated motor current
p0307	0.12 kW	Rated motor output
p0308	0.75	Motor cosPhi:
p0310	50 Hz	Motor frequency
p0311	1350 rpm	Rated motor speed

8 Service, maintenance and fault rectification

8.1 Safety guidelines for service, maintenance and fault rectification

	▲ WARNING
	<p>Risk of injury as a result of improper service, maintenance and fault rectification!</p> <p>Failure to perform service, maintenance or fault rectification correctly can result in serious physical injury or property damage.</p> <ul style="list-style-type: none"> • Service, maintenance and fault rectification must always be carried out by persons with the appropriate training and skills. Compliance with regulations valid in the country of installation is also essential. For further information, please refer to Chapter Personnel requirements [→ 12].

8.2 Service and maintenance

8.2.1 Maintenance schedule

The variable speed drive primarily consists of maintenance-free, electronic components. It is nevertheless necessary to perform the following maintenance at the specified intervals in order to maintain the variable speed drive in a fully functional condition.



Maintenance intervals are determined to a large extent by installation and operating conditions. Siemens offers its customers tailor-made maintenance contracts. For more information, please contact your local Siemens representative.

Monthly

1. Remove dirt and impurities in order to ensure that cooling works effectively.
2. Check that the fans are working properly.
3. Ensure that the cabinet's ventilation slots are not blocked.
4. Check that the cables and screw terminals are correctly fixed in place. If necessary, re-tighten the fastenings for the cables and screw terminals.
5. Check the cables and screw terminals for damage.
6. Replace any defective parts immediately.

Every 40 000 operating hours or as required

1. Check that the fans are working properly.
2. Replace the fan if necessary (Chapter Fan maintenance [→ 95]).

8.2.2 Fan maintenance

The average service life of fans is 40 000 hours. In practice, the service life may differ from this value, in particular in dusty environments.

The fan must be replaced in good time in order to ensure that the drive remains ready for operation.

Replacing the fan

Information about replacing the fan can be found in the following manuals:

Document ID	Title
A5E35319202B	Hardware Installation Manual Power Module PM230 IP55/UL Type 12
A5E34331322B	Hardware Installation Manual Power Module PM230 IP20



NOTICE

The fans are available as spare parts through your local Siemens branch office.

8.3 Fault rectification

The variable speed drive uses the following means to display faults and operating states:

- The LEDs on the front indicate the most important operating states.
- The drive displays alarms and faults via the fieldbus, the terminal strip, a connected operator panel, or via the STARTER software.



Every alarm and fault has a unique number. Using the numbers listed in the table in Chapter Fault table (SW) [→ 97], you can identify the cause of the fault and rectify the problem.

8.3.1 Displayed operating states

The Control Unit has two LEDs which indicate the operating state of the drive:

- LED RDY = Ready
- LED BF = Bus Fault

The LED RDY (Ready) lights up orange temporarily after the power supply voltage is switched on. As soon as the color of the LED RDY changes to red or green, the LED signals the state of the variable speed drive.

In addition to the signal states "On" and "Off" there are two different flashing frequencies:

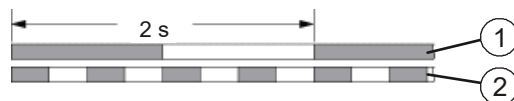

Figure 28: Flashing frequency

Item	Designation	Item	Designation
1	Slow flashing	2	Rapid flashing

The flashing frequencies of the LEDs have the following meaning:

LED		Description
RDY	BF	
Green – steady light	Off	No fault
Green – Slow	Off	Commissioning or reset to factory settings
Red – Fast	Off	No fault
Red – Fast	Red – Fast	Incorrect memory card
Green – steady light	Red – steady light	Receive process data
Green – steady light	Red – Slow	Bus active – no process data
Green – steady light	Red – Fast	No bus activity

8.3.2 Fault table (SW)



The table below contains only an excerpt from the list of alarms and faults. The complete list of alarms and faults can be found in List Manual CU230P A5E33838102, [SIOS Entry-ID: 109782303](#).

Types of fault

Device faults fall into two different categories:

- **Alarms:** Alarms have no direct effect on the variable speed drive and disappear once the cause has been removed. The device and motor continue operating normally. Alarms do not need to be acknowledged.
- **Faults:** A fault indicates a severe fault during variable speed drive operation. In the event of a fault, the connected motor is shut down instantaneously. Operation cannot resume until the fault has been cleared and the fault message acknowledged.

Alarms

Number	Cause	Solution
A01028	Configuration error	Parameterization on the memory card has been created with a different type of module (order number, MLFB). <ul style="list-style-type: none"> ● Check the module parameters and recommission if necessary.
A01098	The power supply for the Control Unit was interrupted for a longer period.	<ol style="list-style-type: none"> 1. Set the date and time of day of the real-time clock: p8400 (RTC time), p8401 (RTC date) 2. Deactivate the alarm: p8405 = 0.
A01590	Motor maintenance interval lapsed	<ul style="list-style-type: none"> ● Carry out maintenance and reset the maintenance interval (p0651).
A01900	PROFIBUS: Configuration telegram faulty	A PROFIBUS master is attempting to establish a connection with a faulty configuration telegram. <ul style="list-style-type: none"> ● Check the bus configuration on the master and slave side.

Number	Cause	Solution
A01910 F01910	Setpoint timeout: p2040 ≠ 0 ms and one of the following causes: <ul style="list-style-type: none"> The bus connection is interrupted The MODBUS master is switched off Communications error (CRC, parity bit, logical error) 	<ol style="list-style-type: none"> Establish the bus connection and switch on the communication partners. Possibly adapt p2040. Set the PROFIBUS master to RUN.
A01920	PROFIBUS: Cyclic connection interrupt	<p>The cyclic connection to the PROFIBUS master is interrupted.</p> <ul style="list-style-type: none"> Establish the PROFIBUS connection and activate the PROFIBUS master with cyclic operation.
A03520	Temperature sensor fault	<ul style="list-style-type: none"> Check that the sensor is correctly connected.
A05000 A05001 A05002 A05004 A05006	Power Module overtemperature	<ol style="list-style-type: none"> Check that the ambient temperature is within the defined limit values. Check that the load conditions and duty cycle are appropriately dimensioned. Check whether there has been a cooling system failure.
A07012	I2t Motor Module overtemperature	<ol style="list-style-type: none"> Reduce the motor load. Check the ambient temperature and the motor ventilation. Check the thermal time constant p0611. Check the overtemperature fault threshold p0605.
A07015	Motor temperature sensor alarm	<ol style="list-style-type: none"> Check that the sensor is correctly connected. Check the parameter assignment (p0601).
A07321	Automatic restart active	<p>Automatic restart is active. During voltage recovery or when remedying the causes of pending faults, the drive is automatically switched back on.</p> <ol style="list-style-type: none"> Block the automatic restart (p1210 = 0). Abort the restart process by removing the switch-on command (p8040).
A07400	DC-link voltage maximum controller (VDC_max controller) active	<p>If intervention by the controller is not desirable:</p> <ol style="list-style-type: none"> Increase the ramp-down times. Deactivate the VDC_max controller (p1240 = 0 for vector control, p1280 = 0 for V/f control).
A07409	V/f control, current limiting controller active	<p>The alarm is automatically canceled after one of the following measures:</p> <ol style="list-style-type: none"> Increase the current limit (p0640). Reduce the load. Reduce the up ramps for the setpoint speed.
A07805	Drive: Power unit overload I2t	<ol style="list-style-type: none"> Reduce the continuous load. Adapt the duty cycle. Check the assignment of rated currents of motor and power unit.
A07850 A07851 A07852	External alarm 1 ... 3	<p>Parameters p2112, p2116 and p2117 determine the signal sources for the external alarm 1... 3.</p> <ul style="list-style-type: none"> The variable speed drive receives an alarm from an external source. Rectify the cause of this alarm.
A07903	Motor speed deviation	<ol style="list-style-type: none"> Increase p2163 or p2166. Increase the torque, current and power limits.

Number	Cause	Solution
A07910	Motor overtemperature	<ol style="list-style-type: none"> 1. Check the motor load. 2. Check the ambient temperature and the motor ventilation. 3. Check the KTY84 / Pt 1000 sensor. 4. Check the overtemperatures of the thermal model (p0626 ... p0628).
A07920 F07923	Torque/speed too low	<p>The torque deviates from the torque/speed envelope curve.</p> <ol style="list-style-type: none"> 1. Check the connection between the motor and load. 2. Adjust the settings according to the load.
A07921 F07924	Torque/speed too high	
A07922	Torque/speed out of tolerance	
A07927	DC braking active	The alarm disappears after DC braking.
A07980	Rotating measurement activated	The alarm disappears after optimization of the speed controller.
A07981	Rotating measurement: No enable signals	<ol style="list-style-type: none"> 1. Acknowledge pending faults. 2. Create enable signals which are missing.
A07991	Motor data identification activated	The alarm disappears after motor data identification.
A30049	Internal fan defective	<ul style="list-style-type: none"> ● Check the internal fan and replace it, if necessary.
A30502	DC link overvoltage	<ol style="list-style-type: none"> 1. Check the device supply voltage (p0210). 2. Check the dimensions of the line reactor.
A30920	Temperature sensor fault	<ul style="list-style-type: none"> ● Check that the sensor is correctly connected.

Faults

Number	Cause	Solution
F01000	Software fault in CU	<ul style="list-style-type: none"> ● Replace the CU.
F01001	FloatingPoint exception	<ul style="list-style-type: none"> ● Switch the CU off and on again.
F01015	Software fault in CU	<ol style="list-style-type: none"> 1. Update the firmware 2. Contact Technical Support. 3. Replace the CU.
F01018	Power-up aborted more than once	<ol style="list-style-type: none"> 1. Switch the module off and on again. 2. After this fault has been output, the module is booted with the factory settings. 3. Recommission the drive.
F01033	Switching over units: Reference parameter value invalid	<ul style="list-style-type: none"> ● Set the value of the reference parameter not equal to 0.0 (p0304, p0305, p0310, p0596, p2000, p2001, p2002, p2003, r2004).
F01034	Switching over units: Calculation of the parameter values after reference value change unsuccessful	<ul style="list-style-type: none"> ● Select the value of the reference parameter so that the parameters involved can be calculated in the representation (p0304, p0305, p0310, p0596, p2000, p2001, p2002, p2003, r2004).
F01040	Parameters must be saved	<ol style="list-style-type: none"> 1. Save the parameters (p0971). 2. Switch the CU off and on again.

Number	Cause	Solution
F01044	Fault loading the data from the memory card	<ul style="list-style-type: none"> ● Replace the memory card of the CU.
F01105	Insufficient memory	<ul style="list-style-type: none"> ● Reduce the number of data records.
F01122	Frequency at the probe input too high	<ul style="list-style-type: none"> ● Reduce the frequency of the pulses at the measuring input.
F01205	Time slice overflow	<ul style="list-style-type: none"> ● Contact Technical Support.
F01250	CU hardware fault	<ul style="list-style-type: none"> ● Replace the CU.
F01512	No scaling	<p>An attempt has been made to establish a conversion factor for scaling which is not present.</p> <ul style="list-style-type: none"> ● Apply scaling or check the transfer value.
F01662	CU hardware fault	<ol style="list-style-type: none"> 1. Switch the CU off and on again. 2. Update the firmware. 3. Contact Technical Support.
A01910 F01910	<p>Setpoint timeout: p2040 ≠ 0 ms and one of the following causes:</p> <ul style="list-style-type: none"> ● The bus connection is interrupted ● The MODBUS master is switched off ● Communications error (CRC, parity bit, logical error) 	<ol style="list-style-type: none"> 1. Establish the bus connection and switch on the communication partners. 2. Possibly adapt p2040. 3. Set the PROFIBUS master to RUN.
F03505	Analog input, wire break	<ol style="list-style-type: none"> 1. Check the connection with the signal source for interruptions. 2. Check the level of the signal which is fed in. <p>The input current measured by the analog input can be read in r0752.</p>
F06310	Supply voltage (p0210) incorrectly parameterized	<ol style="list-style-type: none"> 1. Check the supply voltage and change the parameter (p0210), if necessary. 2. Check the line voltage.
F07011	Motor overtemperature	<ol style="list-style-type: none"> 1. Reduce the motor load. 2. Check the ambient temperature and the motor ventilation. 3. Check the wiring and the connection of the sensor.
F07016	Motor temperature sensor fault	<ol style="list-style-type: none"> 1. Check that the sensor is correctly connected. 2. Check the parameter assignment (p0601). 3. Switch off the temperature sensor error (p0607 = 0).
F07086 F07088	Switching over units: Parameter limit violation	<ul style="list-style-type: none"> ● Check the adapted parameter value and correct it, if necessary.
F07320	Automatic restart aborted	<ol style="list-style-type: none"> 1. Increase the number of restart attempts (p1211). The actual number of start attempts is shown in r1214. 2. Increase the waiting time in p1212 or the monitoring time in p1213. 3. Apply the ON command (p0840). 4. Increase the monitoring time of the power unit or disable the monitoring time (p0857). 5. Reduce the waiting time for resetting the fault counter p1213[1] so that fewer faults are registered in the time interval.

Number	Cause	Solution
F07330	Search current measured too low	<ol style="list-style-type: none"> 1. Increase the search current (p1202). 2. Check that the motor is correctly connected.
F07426	Technology controller actual value limited	<p>The actual value for the technology controller which is interconnected via connector input p2264 has reached a limit.</p> <ol style="list-style-type: none"> 1. Adjust the limits to the signal level (p2267, p2268). 2. Check the actual value (p2264).
F07801	Motor overcurrent	<p>The permissible motor limit current has been exceeded.</p> <ol style="list-style-type: none"> 1. Check the current limits (p0640). 2. Vector control: Check the settings for the current controller (p1715, p1717). 3. V/f control: Check the settings for the current limiting controller (p1340...p1346). 4. Increase the up ramp (p1120) or reduce the load. 5. Check the motor and the motor cables for short-circuits or ground faults. 6. Check the motor for star-delta connection and rating plate parameterization. 7. Check the combination of the power unit and motor. 8. Select the flying restart function (p1200) if switched to rotating motor.
F07806	Regenerative power limit exceeded	<ol style="list-style-type: none"> 1. Increase the down ramp. 2. Reduce the driving load. 3. Use a power unit with a higher regenerative feedback capability. 4. For vector controls, the regenerative power limit in p1531 can be reduced until the fault is no longer activated.
F07807	Short-circuit detected	<ol style="list-style-type: none"> 1. Check the drive connection on the motor side for any phase-to-phase short-circuit. 2. Ensure that no line and motor cables have been accidentally mixed up.
F07860 F07861 F07862	External fault 1...3	<ul style="list-style-type: none"> ● The variable speed drive receives an alarm from an external source. Rectify the causes of this fault.
F07900	Motor blocked	<ol style="list-style-type: none"> 1. Check that the motor can run freely. 2. Check the torque limits (r1538 and r1539). 3. Check the parameters of the "Motor blocked" message (p2175, p2177).
F07901	Motor overspeed	<ol style="list-style-type: none"> 1. Activate precontrol of the speed limiting controller (p1401 bit 7 = 1). 2. Increase the hysteresis for the overspeed signal (p2162).
F07902	Motor stalled	<ol style="list-style-type: none"> 1. Check whether the motor data has been set correctly and perform a motor identification. 2. Check the current limits (p0640, r0067, r0289). If the current limits are too low, the drive cannot be magnetized. 3. Check whether motor cables are disconnected during operation.
A07920 F07923	Torque/speed too low	The torque deviates from the torque/speed envelope curve.
A07921 F07924	Torque/speed too high	<ol style="list-style-type: none"> 1. Check the connection between the motor and load. 2. Adjust the settings according to the load.

Number	Cause	Solution
A07929	No motor detected	The magnitude of the current following enabling of the drive pulses is so small that no motor is detected. <ol style="list-style-type: none"> 1. Check the motor cables, contactors and switches. 2. Reduce the threshold value (p2179, e.g. with synchronous motors) 3. Check the voltage boost of the V/f control (p1310) 4. Carry out a measurement at standstill in order to set the stator resistance (p0350).
A07994	Motor data identification not carried out	The "Vector control" mode is set but motor data identification has not yet been carried out. <ol style="list-style-type: none"> 1. Carry out motor data identification (see p1900). 2. Set the parameters for the "V/f control" (p1300 < 20).
F30001	Power unit: Overcurrent	Check the following settings and components: <ol style="list-style-type: none"> 1. Motor data. Perform commissioning, if necessary. 2. Motor connection method (Y / Δ). 3. V/f operation, the assignment of the rated currents of the motor and power unit. 4. Line quality. 5. The line commutating reactor must be connected properly. 6. Power cable connections. 7. Power cables for short-circuit or ground fault 8. Power cable length 9. Line phases If the fault is still present: <ol style="list-style-type: none"> 1. V/f operation: Increase the up ramp. 2. Reduce the load. 3. Replace the power unit.
F30002	Power unit: DC-link voltage overvoltage	<ol style="list-style-type: none"> 1. Increase the ramp-down time (p1121). 2. Set the rounding times (p1130, p1136). 3. Activate the DC link voltage controller (p1240, p1280). 4. Check the line voltage (p0210). 5. Check the line phases.
F30003	Power unit: DC-link voltage undervoltage	<ol style="list-style-type: none"> 1. Check the line voltage (p0210). 2. Check the line phases.
F30004	Drive overtemperature	<ol style="list-style-type: none"> 1. Check whether the drive fan is running. 2. Check the ambient temperature. 3. Check whether the motor is overloaded. 4. Reduce the pulse frequency.
F30005	I ² t drive overload	<ol style="list-style-type: none"> 1. Check the rated currents of the motor and Power Module. 2. Reduce the current limit p0640. 3. When operating with V/f characteristic: Reduce p1341.
F30011	Line phase failure	<ol style="list-style-type: none"> 1. Check the drive's input fuses. 2. Check the motor cables.
F30015	Motor cable phase failure	<ol style="list-style-type: none"> 1. Check the motor cables. 2. Increase the ramp-up or ramp-down time (p1120).
F30021	Ground fault	<ol style="list-style-type: none"> 1. Check the power cable connections. 2. Check the motor. 3. Check the current transducer. 4. Check the cables and contacts of the brake connection (a wire might be broken).

Number	Cause	Solution
F30022	Power Module: UCE monitoring	<ol style="list-style-type: none"> 1. Check the Power Module. 2. Replace the Power Module, if necessary.
F30027	Time monitoring for DC-link pre-charging	<ol style="list-style-type: none"> 1. Check the supply voltage at the input terminals. 2. Check the line voltage setting (p0210).
F30035	Overtemperature, intake air	<ol style="list-style-type: none"> 1. Check whether the fan is running. 2. Check the fan elements.
F30036	Overtemperature, inside area	<ol style="list-style-type: none"> 3. Check the ambient temperature.
F30037	Rectifier overtemperature	<ol style="list-style-type: none"> 1. Check whether the fan is running. 2. Check the fan elements. 3. Check the ambient temperature. 4. Check the motor load. 5. Check the line phases.
F30052	Incorrect Power Module data	<ol style="list-style-type: none"> 1. Replace the Power Module. 2. Update the CU firmware.
F30662	CU hardware fault	<ol style="list-style-type: none"> 1. Switch the CU off and on again. 2. Update the firmware. 3. Contact Technical Support.
F30664	CU power up aborted	<ol style="list-style-type: none"> 1. Switch the CU off and on again. 2. Update the firmware. 3. Contact Technical Support.
F30850	Software fault in Power Module	<ol style="list-style-type: none"> 1. Replace the Power Module. 2. Contact Technical Support.
F30059	Internal fan defective	<ul style="list-style-type: none"> ● Check the internal fan and replace it, if necessary.

8.3.3 Hardware diagnostics (HW)

	<p>⚠ DANGER</p>
	<p>Voltage hazards!</p> <p>Touching live parts can result in serious physical injury or death</p> <ul style="list-style-type: none"> ● Tests on variable speed drives must always be carried out by persons with the appropriate training and skills. Compliance with regulations valid in the country of installation is also essential. For further information, please refer to Chapter Personnel requirements [→ 12]. ● Ensure that the drive is grounded correctly. ● Switch off the supply line to the drive before carrying out work on the drive or on any of its parts. ● Isolate the power supply to the drive before carrying out work on the drive or on any of its parts. ● After switching off the power supply, wait at least 5 minutes for the capacitor to discharge completely.

The following equipment is required in order to test and inspect hardware:

- Digital multimeter, preferably with a scale for PWM voltage (e.g., Fluke 87)
- PC with the latest version of STARTER
- IOP-2-BT (Intelligent Operator Panel)

8.3.3.1 Tests without a power supply

	⚠ DANGER
	<p>Danger due to electric current!</p> <p>If the terminals are not accessible externally, do not open the device because you will be exposed to a great risk and this will invalidate the warranty.</p> <ul style="list-style-type: none"> • In this case, contact your local Siemens branch office.

Preliminary tests

Check/Test	Description	OK
Disconnect the power supply	<ul style="list-style-type: none"> • Ensure that the drive is disconnected from the line supply. 	<input type="checkbox"/>
Safeguard	<ul style="list-style-type: none"> • Take measures (a mechanical maintenance switch, for example) to prevent the variable speed drive and the connected motor (depending on application) from restarting. 	<input type="checkbox"/>
Ensure that there is no voltage present at the drive.	<ol style="list-style-type: none"> 1. Measure the voltage between L1/L2 and L3. 2. Make sure that the system is completely de-energized. 	<input type="checkbox"/>
Damage caused by external factors	<ul style="list-style-type: none"> • Check whether parts are damaged, for example by corrosion, paint, moisture, oil, dust, powder, etc. 	<input type="checkbox"/>
Electrical damage	<ul style="list-style-type: none"> • Look for evidence of flashovers or burning at the power terminals. These are caused by connecting the power cables incorrectly. 	<input type="checkbox"/>
Fuses	<ol style="list-style-type: none"> 1. Check the sizes of the fuses. 2. Make sure that they are not "open". 	<input type="checkbox"/>

Static check on the drive

The following checks are standard tests. These tests can be performed on most drives which are designed in accordance with the conventional principle "Rectifier – DC bus – IGBT bridge". The DC bus terminals of the PM230/G120P device are not generally used. However, the terminals are accessible on some models.



Set the multimeter to "Diode" in order to measure the terminals.

The following tables show where to connect the test cable on the drive and what test result you are likely to receive. If the variable speed drive fails to pass one of these tests, please proceed according to the instructions given below the tables.

Rectifier tests			
Positive measuring point	Negative measuring point	Expected result	OK
L1	DC +	Diode aperture – typically 0.3 – 0.5V	<input type="checkbox"/>
L2	DC +	Diode aperture – typically 0.3 – 0.5V	<input type="checkbox"/>
L3	DC +	Diode aperture – typically 0.3 – 0.5V	<input type="checkbox"/>

L1	DC-	Diode block – OL/High impedance	<input type="checkbox"/>
L2	DC-	Diode block – OL/High impedance	<input type="checkbox"/>
L3	DC-	Diode block – OL/High impedance	<input type="checkbox"/>
DC +	L1	Diode block – OL/High impedance	<input type="checkbox"/>
DC +	L2	Diode block – OL/High impedance	<input type="checkbox"/>
DC +	L3	Diode block – OL/High impedance	<input type="checkbox"/>
DC-	L1	Diode aperture – typically 0.3 – 0.5V	<input type="checkbox"/>
DC-	L2	Diode aperture – typically 0.3 – 0.5V	<input type="checkbox"/>
DC-	L3	Diode aperture – typically 0.3 – 0.5V	<input type="checkbox"/>

IGBT bridge test			
Positive measuring point	Negative measuring point	Expected result	OK
U	DC +	Diode aperture – typically 0.3...0.5 V	<input type="checkbox"/>
V	DC +	Diode aperture – typically 0.3...0.5 V	<input type="checkbox"/>
W	DC +	Diode aperture – typically 0.3...0.5 V	<input type="checkbox"/>
U	DC-	Diode block – OL/High impedance	<input type="checkbox"/>
V	DC-	Diode block – OL/High impedance	<input type="checkbox"/>
W	DC-	Diode block – OL/High impedance	<input type="checkbox"/>

How to proceed if a fault is discovered

- ▷ The variable speed drive has failed one of these tests:
 - Remove the Power Module (power unit) in order to replace or repair it.
- ▷ A short circuit is present at the input rectifiers or at components of the IGBT bridge:
 - Check the state of fuses in the supply line, of contactors, disconnectors or of the motor itself.



Remember that an apparently open circuit can also occur following a component short-circuit and the resulting strong flow of current.

8.3.3.2 Power test



⚠ DANGER

Danger due to electric current and moving parts during commissioning of equipment or plant!

Components connected to the variable speed drive might move randomly while the drive is being commissioned. Movements of this kind can cause serious physical injury or death.

- Before commissioning the drive, make the system safe, for example by cordoning it off.
- Ensure that all the covers are applied to the drive, and that no live parts are accessible.



Wherever possible, connect measuring equipment before switching the drive on.

Check/Test	Description	OK
Measuring DC bus voltage	The measured DC voltage at the terminals (not available on all types) should correspond to the peak-to-peak voltage of the applied AC input (typically 580 V).	<input type="checkbox"/>
DC bus voltage – from parameter r0070	r0070 is the measured DC bus voltage of the drive. This does not function below 200 V DC. The parameter has access level 3.	<input type="checkbox"/>
DC bus voltage – from parameter r0026	r0026 is the measured, smoothed DC bus voltage of the drive. This does not function below 200 V DC. The parameter has access level 2.	<input type="checkbox"/>
Fan	<ul style="list-style-type: none"> ● Check the incoming supply. If you can hear the sounds of the fan, the incoming supply is okay. 	<input type="checkbox"/>
10 V	<ul style="list-style-type: none"> ● Check the incoming supply between terminals T35 and T36. 10 V are okay. 	<input type="checkbox"/>
24 V	<ul style="list-style-type: none"> ● Check the incoming supply between terminals T9 and T28. 24 V are okay. 	<input type="checkbox"/>

How to proceed if a fault is discovered

- ▷ The variable speed drive has passed all tests except the fan test:
 - Replace the fan as indicated in the Hardware Installation Manual.
- ▷ If the fans are not working and the DC bus monitor shows 0, the Power Module (power unit) may possibly be defective. The monitored DC bus signals indicate that the microcontroller system for the drive is working properly. A problem in the supply voltage could be the result of incorrect wiring. If the problem persists:
 - Remove the wiring and carry out the test again
- ▷ If the problem persists and the fan and the DC monitor are working properly, the cause of the problem may reside in the Control Unit:
 - Check the Control Unit.

8.3.3.3 Function test

Preliminary test



Perform the preliminary tests set out in the table below without the motor connected. Only in this way can you be certain that any faults discovered are attributable to the variable speed drive rather than the connected motor.

Check/Test	Description	OK
MANUAL operation	<ol style="list-style-type: none"> 1. Monitor the motor output terminals using a suitable multimeter which is also capable of measuring PWM voltages. 2. Use an IOP and select "Manual" mode via the appropriate button. 3. Stop the drive with the I and O buttons. 4. Start the drive. 5. Once the test has been completed, reset the operating mode to "AUTO". <p>You can change the output voltage or the speed with the button on the IOP. "Backwards" can be enabled using the "Control" menu on the IOP.</p>	<input type="checkbox"/>
AUTO mode	<ol style="list-style-type: none"> 1. Monitor the motor output terminals using a suitable multimeter which is also capable of measuring PWM voltages. 2. Ask a competent operator to isolate the drive. 3. Ensure that all stop/start functions, etc. are working properly. <p>The output voltage rises in accordance with the requested higher speed until a maximum close to the line voltage is reached unless this value is limited by the system settings. All three phases should exhibit a similar value.</p>	<input type="checkbox"/>

IOP diagnostics

The following procedures are designed to test the wiring. They ensure that the correct signals reach the drive.

If this reveals that the control wiring is correct, either the drive is defective or the configuration is incorrect.

Check/Test	Description	OK
IOP diagnostics – digital inputs	<ol style="list-style-type: none"> 1. Switch the digital signals in the menu "Diagnostics / I/O state / Digital inputs state". 2. Watch the display on the IOP. 	<input type="checkbox"/>
IOP diagnostics – digital outputs	<ol style="list-style-type: none"> 1. Change the drive state in the menu "Diagnostics / I/O state / Digital outputs state". 2. Watch the display on the IOP. 	<input type="checkbox"/>
IOP diagnostics – analog inputs	<ol style="list-style-type: none"> 1. Change the analog signal value in the menu "Diagnostics / I/O state / Analog inputs state". 2. Watch the display on the IOP. 	<input type="checkbox"/>
IOP diagnostics – analog outputs	<ol style="list-style-type: none"> 1. Change the drive state in the menu "Diagnostics / I/O state / Digital outputs state". 2. Watch the display on the IOP. 	<input type="checkbox"/>

IOP simulation

Perform the following checks to test the inputs of the drive. These tests can detect wiring errors and any potential errors in the variable speed drive settings.

Check/Test	Description	OK
IOP I/O simulation	<ol style="list-style-type: none"> 1. Select the "Diagnostics / I/O simulation" menu. 2. If the drive output responds to the simulation steps performed, this indicates that the drive is probably working properly but that the wiring is incorrect. 	<input type="checkbox"/>

How to proceed if a fault is discovered

!	<p>NOTICE</p> <p>Risk of data loss!</p> <p>When you reset parameters to the factory settings, all stored parameters and data will be lost. Once the device has been reset to its factory settings, it must be commissioned again.</p> <ul style="list-style-type: none"> • Make a copy of the working settings before you reset the variable speed drive to its factory settings.
----------	--

- ▷ All tests indicate that the variable speed drive and the wiring are okay:
 - Reset the drive to the factory settings. This will allow you to tell whether the drive has been incorrectly configured. For instructions on how to reset the variable speed drive to the factory settings, refer to Chapter Restoring parameters to factory settings [→ 74].
- ▷ If, having conducted all the measures, you are still unable to commission the drive, it may be defective.
 1. Replace the Control Unit and/or the Power Module.
 2. Contact Technical Support.

9 Technical data

9.1 Functional data

Electrical data	
Power (low overload LO)	0.75 to 90 kW
Line voltage	380 to 480 V 3 AC $\pm 10\%$
Line frequency	47 to 63 Hz
Overload capability of frame sizes A – C (low overload LO)	<ul style="list-style-type: none"> 1.5 x base-load current (150 %) for 3 s every 300 s 1.1 x base-load current (110%) for 57 s every 300 s
Overload capability of frame sizes D – F (low overload LO)	1.1 x base-load current (110%) for 60 s every 300 s
Rated input current (LO: at 40 °C)	2.3 to 166 A (IP55) 2.3 to 135 A (IP20)
Base-load current (LO: at 40 °C)	2.2 to 178 A (IP55) 2.2 to 145 A (IP20)
Operating temperature	0 to 60 °C while derating (see derating factors)
Relative humidity	< 95% RH, non-condensing
Output frequency	0 to 550 Hz
Pulse frequency	4 kHz (default) to 16 kHz. The pulse frequency can be changed manually in 2 kHz steps.
Frequency range that can be skipped	4, parameterizable
Fixed frequencies	15, parameterizable
Digital inputs and outputs	<ul style="list-style-type: none"> 6 DI 3 DO (2 x 230 V AC / 2 A, 1 x 30 V DC / 0.5 A) 4 AI (2 x 0 to 10 V / -10 to 10 V / 0 to 20 mA / 4 to 20 mA, 1 x 0 to 20 mA / 4 to 20 mA / Pt1000 / LG-Ni1000, 1 x Pt1000 / LG-Ni1000) 2 AO (0 to 10 V / 0 to 20 mA / 4 to 20 mA) 1 x KTY/PTC/ThermoClick sensor 2 x PSU-out (10 VDC, 24 VDC) 1 x PSU-in (24 VDC)
Short-circuit current rating (SCCR)	IP55 FSA - FSC: 40kA IP55 FSD - FSF: 65kA IP20 FSA - FSF: 65kA

Permissible cable lengths IP55		
Cable length	Inverter, motor cable	EMC acc. IEC/EN61800-3 ^{*)}
25 m	<ul style="list-style-type: none"> Inverters with Category C2 filters Shielded motor cable 	First Environment, Category C2
	<ul style="list-style-type: none"> Inverters with Category C1 filters Shielded motor cable 	First Environment, Category C1 (in relation to the harmonic currents) ^{*)}
50 m	<ul style="list-style-type: none"> Inverters with Category C2 filters Shielded motor cable 	Second Environment, Category C3
	<ul style="list-style-type: none"> Inverters with Category C1 filters Shielded motor cable 	Second Environment, Category C2 Valid for FSA ... FSC
100 m	<ul style="list-style-type: none"> Inverters with Category C2 filters Unshielded motor cable 	No EMC category
	<ul style="list-style-type: none"> Inverters with Category C1 filters UNshielded motor cable 	No EMC category

*) Category C2 corresponds to class A according to EN 55011. Category C1 corresponds to class B according to EN 55011 for conducted interference emission.

**) Ferrite cores required, see chapter "Establishing a line and motor connection" in the installation manual "SINAMICS G120P PM230 Power Module, IP55", A5E35319202B, [SIOS Entry-ID: 109744235](#).

Permissible cable lengths IP20		
Length	Inverter, motor cable	EMC acc. IEC/EN61800-3 ^{*)}
25 m	<ul style="list-style-type: none"> Inverter with integrated filter (category C2), Shielded motor cable 	Second environment, category C2
50 m	<ul style="list-style-type: none"> Inverter with integrated filter (category C2), Shielded motor cable 	Second environment, category C3
	<ul style="list-style-type: none"> Inverter without filter External category C1 filter Shielded motor cable 	First environment, category C1
	<ul style="list-style-type: none"> Inverter with or without filter Shielded motor cable 	No EMC category
100 m	<ul style="list-style-type: none"> Inverter with or without filter Unshielded motor cable 	No EMC category
150 m	<ul style="list-style-type: none"> Inverter without filter External category C1 filter Shielded motor cable Output reactor 	Second environment, category C2

Mechanical data	
Vibratory load <ul style="list-style-type: none"> • Transport (in transport packaging) according to EN 60721-3-2 • Operation Test values according to EN 60068-2-6 	Class 2M3 Class 3M2
Shock stressing <ul style="list-style-type: none"> • Transport (in transport packaging) according to EN 60721-3-2 All devices and components • Operation Test values according to EN 60068-2-6 Frame sizes A to F 	Class 2M3 Class 3M2

9.2 Conformity

Environmental conditions	
Protection class according to EN 61800-5-1	Class I (with protective conductor system) and Class III (PELV)
Touch protection according to EN 61800-5-1	If used as intended
Permissible ambient and coolant temperature (air) during operation for line-side power components and Power Modules <ul style="list-style-type: none"> Low overload (low overload LO) High overload (high overload HO) 	See derating factors for derating 0 to 40 °C (32 to 104 °F) without derating > 40 to 60 °C (104 to 160 °F) with derating 0 to 50 °C (32 to 122 °F) without derating > 50 to 60 °C (122 to 160 °F) with derating
Permissible ambient and coolant temperature (air) during operation for Control Units and supplementary system components	<ul style="list-style-type: none"> With CU230P-2: 0 to 60 °C (32 to 140 °F) With IOP-2-BT: 0 to 50 °C (32 to 122 °F) With BOP-2: 0 to 50 °C (32 to 122 °F) With SAM: 0 to 50 °C (32 to 122 °F) With blanking cover: 0 to 60 °C (32 to 140 °F) Up to 2000 m above sea level
Climatic ambient conditions <ul style="list-style-type: none"> Storage (in transport packaging) according to EN 60721-3-1 Transport (in transport packaging) according to EN 60721-3-2 Operation acc. to EN 60721-3-3 	Class 1K3 Temperature -25 to 55 °C (-13 to 131 °F) Class 2K4 Temperature -40 to 70 °C (104 to 158 °F), max. humidity 95 % at 40 °C (104 °F) Class 3K3 Condensation, splashwater, and ice formation not permitted (EN 60204, Part 1)
Environmental class/harmful chemical substances: <ul style="list-style-type: none"> Storage (in transport packaging) according to EN 60721-3-1 Transport (in transport packaging) according to EN 60721-3-2 Operation acc. to EN 60721-3-3 	Class 1C2 Class 2C2 Class 3C2
Organic/biological influences: <ul style="list-style-type: none"> Storage (in transport packaging) according to EN 60721-3-1 Transport (in transport packaging) according to EN 60721-3-2 Operation acc. to EN 60721-3-3 	Class 1B1 Class 2B1 Class 3B1
Degree of pollution according to EN 61800-5-1	2

Directives and standards

Description



The following directives and standards are relevant for the converters:

European Low Voltage Directive

The converters fulfill the requirements stipulated in the Low-Voltage Directive 2014/35/EU, if they are covered by the application area of this directive.

European Machinery Directive

The converters fulfill the requirements stipulated in the Machinery Directive 2006/42/EC, if they are covered by the application area of this directive.

However, the use of the converters in a typical machine application has been fully assessed for compliance with the main regulations in this directive concerning health and safety.

Directive 2011/65/EU

The converter fulfills the requirements of Directive 2011/65/EU relating to the restriction of the use of certain hazardous substances in electrical and electronic devices (RoHS).

Electromagnetic compatibility

Electromagnetic compatibility	
EMC Directive acc. to EN 61800-3 2019 <ul style="list-style-type: none"> Frame sizes FSA to FSF with integrated line filter Class A Frame sizes FSA to FSF with integrated or external line filter Class B 	With shielded motor cable up to 25 m: Category C2, corresponds to Class A acc. to EN 55011 Category C1, corresponds to Class B acc. to EN 55011 for conducted interference emission
Variable-speed electrical power drive systems – Part 3: EMC product standard including specific test methods	EN 61800-3: 2019
Electromagnetic compatibility – Part 3-12: Limit values for temperature monitoring	EN 61000-3-12: 2012 (RSCE > 250)

European EMC Directive

The compliance of the converter with the regulations of the Directive 2014/30/EU has been verified through full compliance with IEC/EN 61800-3.

Underwriters Laboratories (North American market)

Converters provided with one of the test symbols displayed fulfill the requirements stipulated for the North American market as a component of drive applications, and are appropriately listed.



EMC requirements for South Korea

The converters with the KC marking on the rating plate satisfy the EMC requirements for South Korea.



Eurasian conformity

The converters comply with the requirements of the Russia/Belarus/Kazakhstan customs union (EAC).



Australia and New Zealand (RCM formerly C-Tick)

The converters showing the test symbols fulfill the EMC requirements for Australia and New Zealand.

Immunity to voltage drop of semiconductor process equipment

The converters comply with the requirements of standard SEMI F47-0706.

China-RoHs

The converters comply with the China-RoHs directive. Further information is provided on the Internet:

China-RoHs (<https://support.industry.siemens.com/cs/ww/de/view/109738656>)

Quality systems

Siemens AG employs a quality management system that meets the requirements of ISO 9001 and ISO 14001.

Further information

Certificates for download

- EC Declaration of Conformity:
(<https://support.industry.siemens.com/cs/ww/de/view/58275445>)
- Certificates for the relevant directives, prototype test certificates, manufacturers declarations and test certificates for functions relating to functional safety ("Safety Integrated"):
(<http://support.automation.siemens.com/WW/view/en/22339653/134200>)
- Certificates for products that were certified by UL:
(<http://database.ul.com/cgi-bin/XYV/template/LISEXT/1FRAME/index.html>)
- Certificates for products that were certified by TÜV SÜD:
(https://www.tuevsued.de/industrie_konsumprodukte/zertifikatsdatenbank)



Standards that are not relevant

The converters do not fall in the area of validity of the China Compulsory Certification (CCC).



IP20 devices are "UL open type" certified and therefore suitable for use in control cabinets.

The corresponding certificate can be viewed at

<https://productiq.ulprospector.com/en/profile/82461/nmms.e121068?term=Sinami%20G120P&page=1>.

10 Appendix Commissioning report

Parameter	Function	Factory setting	Setting
P0970	Restoring the factory setting	-	
P1300	Control type	2 (U/f parabolic)	
P0100	Motor standard	0 (IEC motor)	
P0304	Rated motor voltage [V]		
P0305	Rated motor current [A]		
P0307	Motor power [kW]		
P0311	Rated motor speed [rpm]		
P1900	Motor data identification selection	0	
P0015	Macro parameter	12	
P1080	Minimum speed [rpm]	0	
P1120	Ramp-up time [s]	10	
P1121	Ramp-down time [s]	30	
P0601	Motor temperature sensor	0 (no sensor)	
P0731 (0)	Digital output function 0	52.3 (Fault)	
P0732 (0)	Digital output function 1	52.7 (Alarm)	
P0732 (0)	Digital output function 2	52.3 (Operation)	
P0757 (0)	x1 value for ADC scaling [V / mA]	0	
P0758 (0)	y1 value for ADC scaling [%]	0	
P1082	Maximum speed [rpm]	1500	
P1200	Flying restart operating mode	0 (flying restart inactive)	
P1210	Automatic Restart	0 (disabled)	
P1211	No. of start attempts	3	
P1212	Time until the first restart [s]	1	
P1213[0]	Monitoring time for restart [s]	60	
P1213[1]	Time to reset the start counter [s]	0	
P1240	Configuration of the Vdc controller	1	
P1820	Reverse output phase sequence	0	
P2000	Reference speed [rpm]	1500	

Issued by
Siemens Switzerland Ltd
Smart Infrastructure
Global Headquarters
Theilerstrasse 1a
6300 Zug
Switzerland
Tel. +41 58-724 24 24
www.siemens.com/buildingtechnologies

© Siemens Switzerland Ltd, 2021
Technical specifications and availability subject to change without notice.