

SIEMENS

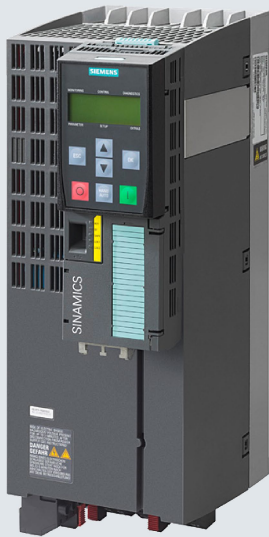

Communication

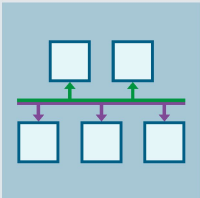

Function manual

SINAMICS

SINAMICS G110M, G120, G120P, G120C,
G120D

Fieldbuses

Edition

04/2018

www.siemens.com/drives

SIEMENS

SINAMICS

SINAMICS G120, G120P, G120C, G120D, G110M Fieldbuses

Function Manual

Preface

Fundamental safety
instructions

1

General information

2

Communication via
PROFIBUS and PROFINET

3

Communication via
EtherNet/IP

4

Communication via RS485

5

Communication over
CANopen

6

Communication via AS-i -
only for G110M

7

Appendix

A

Edition 04/2018, firmware V4.7 SP10



04/2018, FW V4.7 SP10

A5E34229197B AE

Legal information

Warning notice system

This manual contains notices you have to observe in order to ensure your personal safety, as well as to prevent damage to property. The notices referring to your personal safety are highlighted in the manual by a safety alert symbol, notices referring only to property damage have no safety alert symbol. These notices shown below are graded according to the degree of danger.

 DANGER
indicates that death or severe personal injury will result if proper precautions are not taken.
 WARNING
indicates that death or severe personal injury may result if proper precautions are not taken.
 CAUTION
indicates that minor personal injury can result if proper precautions are not taken.
NOTICE
indicates that property damage can result if proper precautions are not taken.

If more than one degree of danger is present, the warning notice representing the highest degree of danger will be used. A notice warning of injury to persons with a safety alert symbol may also include a warning relating to property damage.

Qualified Personnel

The product/system described in this documentation may be operated only by **personnel qualified** for the specific task in accordance with the relevant documentation, in particular its warning notices and safety instructions. Qualified personnel are those who, based on their training and experience, are capable of identifying risks and avoiding potential hazards when working with these products/systems.

Proper use of Siemens products

Note the following:

 WARNING
Siemens products may only be used for the applications described in the catalog and in the relevant technical documentation. If products and components from other manufacturers are used, these must be recommended or approved by Siemens. Proper transport, storage, installation, assembly, commissioning, operation and maintenance are required to ensure that the products operate safely and without any problems. The permissible ambient conditions must be complied with. The information in the relevant documentation must be observed.

Trademarks

All names identified by ® are registered trademarks of Siemens AG. The remaining trademarks in this publication may be trademarks whose use by third parties for their own purposes could violate the rights of the owner.

Disclaimer of Liability

We have reviewed the contents of this publication to ensure consistency with the hardware and software described. Since variance cannot be precluded entirely, we cannot guarantee full consistency. However, the information in this publication is reviewed regularly and any necessary corrections are included in subsequent editions.

Preface

About this manual

This manual describes the settings and preconditions that are required to communicate with a higher-level control system with the subsequently listed fieldbus systems.

Fieldbuses for SINAMICS G120

- PROFIBUS DP
- PROFINET
- EtherNet/IP
- USS
- Modbus RTU
- CANopen

Additional fieldbuses for SINAMICS G120P

- BACnet MS/TP
- P1

Additional fieldbuses for SINAMICS G110M

- AS-Interface

Changes in this edition

Inverter settings are described in the context of the Startdrive PC commissioning tool. The descriptions for settings using STARTER have been removed.

What is the meaning of the symbols in the manual?



Reference to further information in the manual



Download from the Internet



DVD that can be ordered

End of a handling instruction.



Table of contents

	Preface	3
1	Fundamental safety instructions	9
1.1	General safety instructions	9
1.2	Warranty and liability for application examples	9
1.3	Industrial security	10
2	General information	13
2.1	Ethernet and PROFINET protocols that are used	14
3	Communication via PROFIBUS and PROFINET	17
3.1	PROFIDRIVE profile - Cyclic communication	17
3.1.1	Assigning control and status words	21
3.1.1.1	Control and status word 1	21
3.1.1.2	Control and status word 2	25
3.1.1.3	Control and status word 3	26
3.1.2	NAMUR message word	28
3.1.3	Control and status word, encoder	29
3.1.4	Position actual value of the encoder	31
3.1.5	Extend telegrams and change signal interconnection	33
3.1.6	Data structure of the parameter channel	35
3.1.6.1	Application examples	39
3.1.7	Slave-to-slave communication	41
3.2	PROFIDRIVE profile - Acyclic communication	42
3.3	PROFdrive profile - Diagnostic channels	47
3.3.1	Diagnostics with PROFINET	48
3.3.2	Diagnostics with PROFIBUS	50
3.4	Identification & maintenance data (I&M)	54
3.5	S7 communication	55
3.5.1	Directly accessing a SINAMICS G120 converter from a SIMATIC panel	55
3.6	Communication via PROFINET	59
3.6.1	Converter with PROFINET interface	61
3.6.2	Integrating inverters into PROFINET	62
3.6.3	PROFINET IO operation	63
3.6.3.1	What do you have to set for communication via PROFINET?	63
3.6.3.2	Configuring communication to the control	63
3.6.3.3	Installing GSDML	65
3.6.3.4	Activating diagnostics via the control	65
3.6.4	PROFenergy	65
3.6.4.1	General inverter behavior when in the PROFenergy energy-saving mode	66
3.6.4.2	Supported PROFenergy energy-saving modes	66
3.6.4.3	Settings and displays for PROFenergy in the inverter	67
3.6.4.4	Control commands and status queries	68

3.6.5	The inverter with PROFINET interface as Ethernet node.....	70
3.7	Communication via PROFIBUS.....	72
3.7.1	Inverters with PROFIBUS interface.....	73
3.7.2	What do you have to set for communication via PROFIBUS?.....	75
3.7.3	Integrating inverters into PROFIBUS.....	76
3.7.4	Configuring communication to the control system.....	76
3.7.4.1	Configuring the communication using SIMATIC S7 control.....	76
3.7.4.2	Configuring the communication with a third-party control system.....	76
3.7.4.3	Installing the GSD.....	77
3.7.5	Setting the address.....	78
3.8	Select telegram.....	79
4	Communication via EtherNet/IP.....	81
4.1	Inverters with Ethernet/IP interface.....	82
4.2	Connect converter to Ethernet/IP.....	84
4.3	What do you need for communication via Ethernet/IP?.....	85
4.4	Configuring communication via EtherNet/IP.....	86
4.4.1	Communication settings.....	86
4.4.2	Special issues if you wish to use the ODVA AC/DC Drive profile.....	87
4.5	Supported objects.....	88
4.5.1	Supported ODVA AC/DC assemblies.....	102
4.6	Create generic I/O module.....	103
4.7	The inverter as an Ethernet station.....	104
5	Communication via RS485.....	107
5.1	Inverter with RS485 interface.....	108
5.2	Integrating inverters into a bus system via the RS485 interface.....	110
5.3	Communication via USS.....	111
5.3.1	Basic settings for communication.....	111
5.3.1.1	Setting the address.....	112
5.3.1.2	Parameters to set communication via USS.....	113
5.3.2	Telegram structure.....	114
5.3.3	User data range of the USS telegram.....	115
5.3.4	USS parameter channel.....	116
5.3.4.1	Telegram examples, length of the parameter channel = 4.....	120
5.3.5	USS process data channel (PZD).....	122
5.3.6	Time-out and other errors.....	123
5.4	Communication using Modbus RTU.....	125
5.4.1	Basic settings for communication.....	126
5.4.1.1	Setting the address.....	127
5.4.1.2	Parameters for Modbus communication settings.....	128
5.4.2	Modbus RTU telegram.....	130
5.4.3	Baud rates and mapping tables.....	131
5.4.4	Mapping tables - inverter data.....	133
5.4.5	Acyclic communication via Modbus RTU.....	136
5.4.6	Write and read access using function codes.....	137
5.4.7	Acyclically read and write parameter via FC 16.....	140

5.4.7.1	Read parameter	141
5.4.7.2	Write parameter	142
5.4.8	Communication procedure.....	144
5.4.9	Application example.....	145
5.5	Communication via BACnet MS/TP - only CU230P-2 HVAC / BT	146
5.5.1	Basic settings for communication	147
5.5.1.1	Setting the address	148
5.5.1.2	Parameters for setting communication via BACnet	149
5.5.2	Supported services and objects.....	151
5.5.3	Acyclic communication (general parameter access) via BACnet	160
5.6	Communication via P1 - only CU230P-2 HVAC, CU230P-2 BT.....	162
5.6.1	Basic settings for communication via P1	163
5.6.2	Setting the address	164
5.6.3	Point numbers.....	165
6	Communication over CANopen	169
6.1	Network management (NMT service).....	172
6.2	SDO services	175
6.2.1	Access to SINAMICS parameters via SDO	175
6.2.2	Access PZD objects via SDO	177
6.3	PDO services	179
6.3.1	Predefined connection set	182
6.3.2	Free PDO mapping	184
6.3.3	Interconnect objects from the receive and transmit buffers.....	187
6.3.4	Free PDO mapping for example of the actual current value and torque limit.....	189
6.4	CANopen operating modes	191
6.5	RAM to ROM via the CANopen object 1010	193
6.6	Object directories	194
6.6.1	General objects from the CiA 301 communication profile	194
6.6.2	Free objects	203
6.6.3	Objects from the CiA 402 drive profile	204
6.7	Integrating the inverter into CANopen	206
6.7.1	Connecting inverter to CAN bus	207
6.7.2	Setting the node ID and baud rate.....	207
6.7.3	Setting the monitoring of the communication	208
6.8	Error diagnostics	210
6.9	CAN bus sampling time	214
7	Communication via AS-i - only for G110M	215
7.1	Setting the address	217
7.2	Single Slave mode.....	219
7.3	Dual Slave mode.....	221
7.4	Assignment tables.....	224
7.5	Cyclic and acyclic communication via CTT2	226
7.5.1	Cyclic communication	227

7.5.2	Acyclic communication - standard	228
7.5.3	Acyclic communication - manufacturer-specific.....	228
A	Appendix	231
A.1	Application examples for communication with STEP7.....	231
A.2	Manuals and technical support	232
A.2.1	Overview of the manuals	232
A.2.2	Configuring support.....	236
A.2.3	Product Support	237
	Index	239

Fundamental safety instructions

1.1 General safety instructions

 WARNING
Danger to life if the safety instructions and residual risks are not observed If the safety instructions and residual risks in the associated hardware documentation are not observed, accidents involving severe injuries or death can occur. <ul style="list-style-type: none">• Observe the safety instructions given in the hardware documentation.• Consider the residual risks for the risk evaluation.

 WARNING
Malfunctions of the machine as a result of incorrect or changed parameter settings As a result of incorrect or changed parameterization, machines can malfunction, which in turn can lead to injuries or death. <ul style="list-style-type: none">• Protect the parameterization (parameter assignments) against unauthorized access.• Handle possible malfunctions by taking suitable measures, e.g. emergency stop or emergency off.

1.2 Warranty and liability for application examples

Application examples are not binding and do not claim to be complete regarding configuration, equipment or any eventuality which may arise. Application examples do not represent specific customer solutions, but are only intended to provide support for typical tasks.

As the user you yourself are responsible for ensuring that the products described are operated correctly. Application examples do not relieve you of your responsibility for safe handling when using, installing, operating and maintaining the equipment.

1.3 Industrial security

Note

Industrial security

Siemens provides products and solutions with industrial security functions that support the secure operation of plants, systems, machines and networks.

In order to protect plants, systems, machines and networks against cyber threats, it is necessary to implement – and continuously maintain – a holistic, state-of-the-art industrial security concept. Siemens' products and solutions constitute one element of such a concept.

Customers are responsible for preventing unauthorized access to their plants, systems, machines and networks. Such systems, machines and components should only be connected to an enterprise network or the Internet if and to the extent such a connection is necessary and only when appropriate security measures (e.g. firewalls and/or network segmentation) are in place.

For additional information on industrial security measures that may be implemented, please visit:

Industrial security (<http://www.siemens.com/industrialsecurity>)

Siemens' products and solutions undergo continuous development to make them more secure. Siemens strongly recommends that product updates are applied as soon as they are available and that the latest product versions are used. Use of product versions that are no longer supported, and failure to apply the latest updates may increase customer's exposure to cyber threats.

To stay informed about product updates, subscribe to the Siemens Industrial Security RSS Feed at:

Industrial security (<http://www.siemens.com/industrialsecurity>)

Further information is provided on the Internet:

Industrial Security Configuration Manual
(<https://support.industry.siemens.com/cs/ww/en/view/108862708>)

 **WARNING****Unsafe operating states resulting from software manipulation**

Software manipulations (e.g. viruses, trojans, malware or worms) can cause unsafe operating states in your system that may lead to death, serious injury, and property damage.

- Keep the software up to date.
- Incorporate the automation and drive components into a holistic, state-of-the-art industrial security concept for the installation or machine.
- Make sure that you include all installed products into the holistic industrial security concept.
- Protect files stored on exchangeable storage media from malicious software by with suitable protection measures, e.g. virus scanners.
- Protect the drive against unauthorized changes by activating the "know-how protection" drive function.

General information

Communication with the control, even when the line voltage is switched off

If, in your plant or system, communication with the control system should continue to function even when the line voltage is switched off, then you must externally supply the inverter/Control Unit with 24 V DC. To do this, use terminals 31 and 32 – or connector X01. You can find additional details in the operating instructions for the inverter or the Control Unit.

2.1 Ethernet and PROFINET protocols that are used

The inverter supports the protocols listed in the following tables. The address parameters, the relevant communication layer as well as the communication role and the communication direction are specified for each protocol.

You require this information to set the appropriate safety measures to protect the automation system, e.g. in the firewall.

As the security measures are limited to Ethernet and PROFINET networks, no PROFIBUS protocols are listed in the table.

Table 2- 1 PROFINET protocols

Protocol	Port number	Layer (2) Link layer (4) Transport layer	Function/description
DCP: Discovery and configuration protocol	Not relevant	(2) Ethernet II and IEEE 802.1Q and EtherType 0x8892 (PROFINET)	Accessible stations, PROFINET Discovery and configuration DCP is used by PROFINET to determine PROFINET devices and to make basic settings. DCP uses the special multicast MAC address: xx-xx-xx-01-0E-CF, xx-xx-xx = Organizationally Unique Identifier
LLDP: Link Layer Discovery Protocol	Not relevant	(2) Ethernet II and IEEE 802.1Q and EtherType 0x88CC (PROFINET)	PROFINET Link Layer Discovery protocol LLDP is used by PROFINET to determine and manage neighborhood relationships between PROFINET devices. LLDP uses the special multicast MAC address: 01-80-C2-00-00-0E
MRP: Media Redundancy Protocol	Not relevant	(2) Ethernet II and IEEE 802.1Q and EtherType 0x88E3 (PROFINET)	PROFINET medium redundancy MRP enables the control of redundant routes through a ring topology. MRP uses the special multicast MAC address: xx-xx-xx-01-15-4E, xx-xx-xx = Organizationally Unique Identifier
PTCP Precision Transparent Clock Protocol	Not relevant	(2) Ethernet II and IEEE 802.1Q and EtherType 0x8892 (PROFINET)	PROFINET send clock and time synchronization, based on IEEE 1588 PTC is used to implement send clock synchronization and time synchronization between RJ45 ports, which are required for IRT operation. PTCP uses the special multicast MAC address: xx-xx-xx-01-0E-CF, xx-xx-xx = Organizationally Unique Identifier
PROFINET IO data	Not relevant	(2) Ethernet II and IEEE 802.1Q and EtherType 0x8892 (PROFINET)	PROFINET Cyclic IO data transfer The PROFINET IO telegrams are used to transfer IO data cyclically between the PROFINET IO controller and IO devices via Ethernet.
PROFINET Context Manager	34964	(4) UDP	PROFINET connection less RPC The PROFINET context manager provides an endpoint mapper in order to establish an application relationship (PROFINET AR).

Table 2- 2 Ethernet/IP protocols

Protocol	Port number	Layer (2) Link layer (4) Transport layer	Function/description
Implicit messaging	2222	(4) UDP	Used for exchanging I/O data. This is inactive when delivered. Is activated when selecting Ether-Net/IP.
Explicit messaging	44818	(4) TCP (4) UDP	Used for parameter access (writing, reading). This is inactive when delivered. Is activated when selecting Ether-Net/IP.

Table 2- 3 Connection-oriented communication protocols

Protocol	Port number	Layer (2) Link layer (4) Transport layer	Function/description
ISO on TCP (according to RFC 1006)	102	(4) TCP	ISO-on-TCP protocol ISO on TCP (according to RFC 1006) is used for the message-oriented data exchange to a remote CPU, WinAC or devices of other suppliers. Communication with ES, HMI, etc. is activated in the factory setting, and is always required.
SNMP Simple Network Management Protocol	161	(4) UDP	Simple network management protocol SNMP enables network management data to be read out and set (SNMP managed objects) by the SNMP manager. It is activated in the factory setting, and is always required
Reserved	49152 ... 65535	(4) TCP (4) UDP	Dynamic port area that is used for the active connection endpoint if the application does not specify the local port.

Communication via PROFIBUS and PROFINET

3.1 PROFIDRIVE profile - Cyclic communication

Depending on the Control Unit or inverter, there are different telegrams for communication via PROFIBUS DP or PROFINET IO. The structure of the individual telegrams are listed below.

The Startdrive commissioning tool or an operator panel only list the telegrams for selection that are possible with your particular inverter.

How to commission the inverter and select a telegram are described in the operating instructions.



Overview of the manuals (Page 232)

Communication telegrams if "basic positioner" has been configured

The inverter has the following telegrams if you have configured the "Basic positioner" function:

- Standard telegram 7, PZD-2/2
- Standard telegram 9, PZD-10/5
- SIEMENS telegram 110, PZD-12/7
- SIEMENS telegram 111, PZD-12/12
- Telegram 999, free interconnection

Telegrams 7, 9, 110 and 111 are described in the "Basic positioner" Function Manual



Overview of the manuals (Page 232)

Communication telegrams for speed control

The send and receive telegrams of the inverter for closed-loop speed control are structured as follows:

Telegram 1

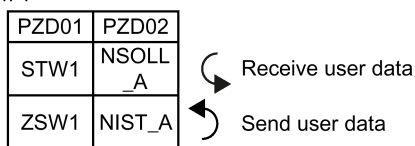

Figure 3-1 16-bit speed setpoint

3.1 PROFIDRIVE profile - Cyclic communication

Telegram 2

PZD01	PZD02	PZD03	PZD04
STW1	NSOLL_B		STW2
ZSW1	NIST_B		ZSW2

Figure 3-2 32-bit speed setpoint

Telegram 3

PZD01	PZD02	PZD03	PZD04	PZD05	PZD06	PZD07	PZD08	PZD09
STW1	NSOLL_B		STW2	G1_STW				
ZSW1	NIST_B		ZSW2	G1_ZSW	G1_XIST1	G1_XIST2		

Figure 3-3 32-bit speed setpoint with 1 position encoder

Telegram 4

PZD01	PZD02	PZD03	PZD04	PZD05	PZD06	PZD07	PZD08	PZD09	PZD10	PZD11	PZD12	PZD13	PZD14
STW1	NSOLL_B		STW2	G1_STW	G2_STW								
ZSW1	NIST_B		ZSW2	G1_ZSW	G1_XIST1	G1_XIST2		G2_ZSW	G2_XIST1		G2_XIST2		

Figure 3-4 32-bit speed setpoint with 2 position encoders

Telegram 20

PZD01	PZD02	PZD03	PZD04	PZD05	PZD06
STW1	NSOLL_A				
ZSW1	NIST_A GLATT	IAIST_A GLATT	MIST_A GLATT	PIST_A GLATT	MELD_A NAMUR

Figure 3-5 16-bit speed setpoint for VIK-Namur

Telegram 350

PZD01	PZD02	PZD03	PZD04
STW1	NSOLL_A	M_LIM	STW3
ZSW1	NIST_A GLATT	IAIST_A GLATT	ZSW3

Figure 3-6 16-bit speed setpoint with torque limiting

Telegram 352

PZD01	PZD02	PZD03	PZD04	PZD05	PZD06
STW1	NSOLL_A	Process data for PCS7			
ZSW1	NIST_A GLATT	IAIST_A GLATT	MIST_A GLATT	WARN_CODE	FAULT_CODE

Figure 3-7 16-bit speed setpoint for PCS7

Telegram 353

	PZD01	PZD02
PKW	STW1	NSOLL_A
	ZSW1	NIST_A GLATT

Figure 3-8 16-bit speed setpoint with PKW range to read and write parameters

Telegram 354

	PZD01	PZD02	PZD03	PZD04	PZD05	PZD06
PKW	STW1	NSOLL_A	Process data for PCS7			
	ZSW1	NIST_A GLATT	IAIST_ GLATT	MIST_ GLATT	WARN_ CODE	FAULT_ CODE

Figure 3-9 16-bit speed setpoint for PCS7 with PKW range to read and write parameters

Telegram 999

	PZD01	PZD02	PZD03	PZD04	PZD05	PZD06	PZD07	PZD08	PZD09	PZD10	PZD11	PZD12	PZD13 ... PZD17
	STW1	Telegram length for the receive data											
	ZSW1	Telegram length for the transmit data											

Figure 3-10 Telegram with free interconnection and length

Abbreviation	Explanation	Abbreviation	Explanation
PZD	Process data	PKW	Parameter channel
STW	Control word	PIST_GLATT	Actual active power value, smoothed
ZSW	Status word	M_LIM	Torque limit
NSOLL_A	Speed setpoint 16 bit	FAULT_COD E	Fault code
NSOLL_B	Speed setpoint 32 bit	WARN_COD E	Alarm code
NIST_A	Speed actual value 16 bit	MELD_NAMU R	Message according to the VIK-NAMUR definition
NIST_B	Speed actual value 32 bit	G1_STW / G2_STW	Control word for encoder 1 or encoder 2
IAIST	Current actual value	G1_ZSW / G2_ZSW	Status word for encoder 1 or encoder 2
IAIST_GLATT	Current actual value, smoothed	G1_XIST1 / G2_XIST1	Position actual value 1 from encoder 1 or encoder 2
MIST_GLATT	Torque actual value, smoothed	G1_XIST2 / G2_XIST2	Position actual value 2 from encoder 1 or encoder 2

Interconnection of the process data

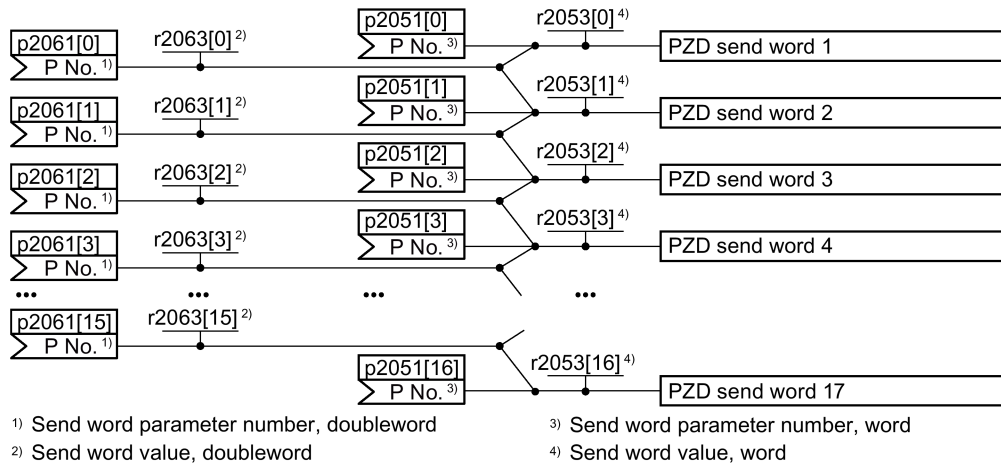

Figure 3-11 Interconnection of the send words

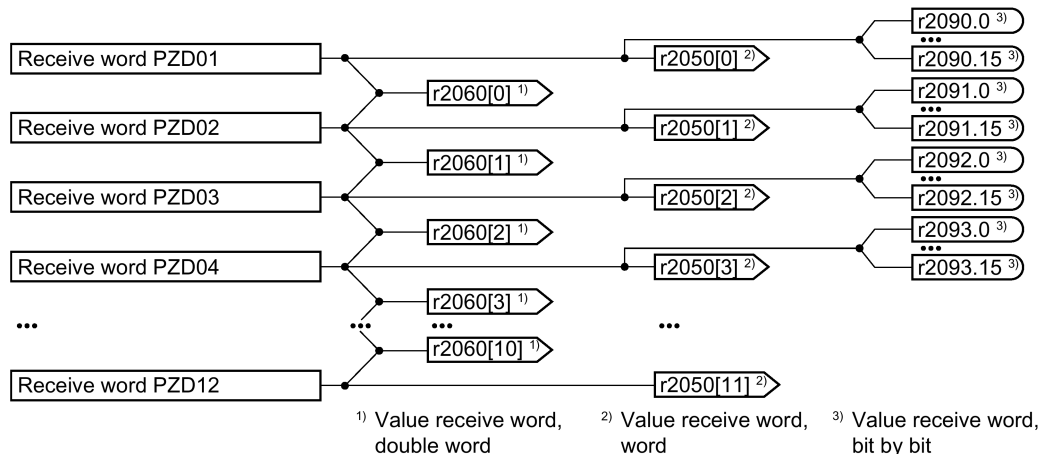

Figure 3-12 Interconnection of the receive words

The telegrams use - with the exception of telegram 999 (free interconnection) - the word-by-word transfer of send and receive data (r2050/p2051).

If you require an individual telegram for your application (e.g. for transferring double words), you can adapt one of the predefined telegrams using parameters p0922 and p2079. For details, please refer to the List Manual, function diagrams 2420 and 2472.

3.1.1 Assigning control and status words

Assigning control and status of words is specified in part by the definitions in the PROFIdrive profile, Version 4.2 for the "Closed-loop speed control" operating mode; the other part is assigned depending on the particular manufacturer.

A more detailed description of the individual control and status words is provided in the following sections.

If you require an individual assignment for your application, you can adapt one of the existing control and status words using p0922 and p2079.



Extend telegrams and change signal interconnection (Page 33)

3.1.1.1 Control and status word 1

Control word 1 is preassigned as follows:

- Telegrams 1, 2, 3 and 4:
 - Bits 0 ... 10 corresponding to the PROFIdrive profile,
 - Bits 11... 15 manufacturer-specific
- Telegrams 7 and 9:
 - Bits 0 ... 11 corresponding to the PROFIdrive profile,
 - Bits 12 ... 15 manufacturer-specific
- Telegram 20 (VIK/NAMUR):
 - Bits 0 ... 11 corresponding to the PROFIdrive profile
 - Bits 12 ... 14 reserved
 - Bit 15 corresponding to the PROFIdrive profile

Status word 1 is preassigned as follows:

- Telegrams 1, 2, 3 and 4:
 - Bits 0 ... 10 corresponding to the PROFIdrive profile,
 - Bits 11... 15 manufacturer-specific
- Telegrams 7 and 9:
 - Bits 0 ... 13 corresponding to the PROFIdrive profile,
 - Bits 14 ... 15 manufacturer-specific
- Telegram 20 (VIK/NAMUR):
 - Bits 0 ... 11 corresponding to the PROFIdrive profile
 - Bit 12 reserved
 - Bits 13 ... 15 corresponding to the PROFIdrive profile

Control word 1 (STW1)

Bit	Significance		Explanation	Signal inter-connection in the in-verter
	Telegram 20	All other tele-grams		
0	0 = OFF1		The motor brakes with the ramp-down time p1121 of the ramp-function generator. The inverter switches off the motor at standstill.	p0840[0] = r2090.0
	0 → 1 = ON		The inverter goes into the "ready" state. If, in addition bit 3 = 1, then the inverter switches on the motor.	
1	0 = OFF2		Switch off the motor immediately, the motor then coasts down to a standstill.	p0844[0] = r2090.1
	1 = No OFF2		The motor can be switched on (ON command).	
2	0 = Quick stop (OFF3)		Quick stop: The motor brakes with the OFF3 ramp-down time p1135 down to standstill.	p0848[0] = r2090.2
	1 = No quick stop (OFF3)		The motor can be switched on (ON command).	
3	0 = Inhibit operation		Immediately switch-off motor (cancel pulses).	p0852[0] = r2090.3
	1 = Enable operation		Switch-on motor (pulses can be enabled).	
4	0 = Disable RFG		The inverter immediately sets its ramp-function generator output to 0.	p1140[0] = r2090.4
	1 = Do not disable RFG		The ramp-function generator can be enabled.	
5	0 = Stop RFG		The output of the ramp-function generator stops at the actual value.	p1141[0] = r2090.5
	1 = Enable RFG		The output of the ramp-function generator follows the setpoint.	
6	0 = Inhibit setpoint		The inverter brakes the motor with the ramp-down time p1121 of the ramp-function generator.	p1142[0] = r2090.6
	1 = Enable setpoint		Motor accelerates with the ramp-up time p1120 to the setpoint.	
7	0 → 1 = Acknowledge faults		Acknowledge fault. If the ON command is still active, the inverter switches to the "switching on inhibited" state.	p2103[0] = r2090.7
8, 9	Reserved			
10	0 = No control via PLC		Inverter ignores the process data from the fieldbus.	p0854[0] = r2090.10
	1 = Control via PLC		Control via fieldbus, inverter accepts the process data from the fieldbus.	
11	1 = Direction reversal		Invert setpoint in the inverter.	p1113[0] = r2090.11
12	Not used			
13	--- ¹⁾	1 = MOP up	Increase the setpoint saved in the motorized potentiometer.	p1035[0] = r2090.13

Bit	Significance		Explanation	Signal inter-connection in the in-verter
	Telegram 20	All other tele-grams		
14	--- ¹⁾	1 = MOP down	Reduce the setpoint saved in the motorized potentiometer.	p1036[0] = r2090.14
15	CDS bit 0	Reserved	Changes over between settings for different operation interfaces (command data sets).	p0810 = r2090.15

¹⁾ If you change over from another telegram to telegram 20, then the assignment of the previous telegram is kept.

Status word 1 (ZSW1)

Bit	Significance		Remarks	Signal inter-connection in the in-verter
	Telegram 20	All other tele-grams		
0	1 = Ready for switching on		Power supply switched on; electronics initialized; pulses locked.	p2080[0] = r0899.0
1	1 = Ready		Motor is switched on (ON/OFF1 = 1), no fault is active. With the command "Enable operation" (STW1.3), the inverter switches on the motor.	p2080[1] = r0899.1
2	1 = Operation enabled		Motor follows setpoint. See control word 1, bit 3.	p2080[2] = r0899.2
3	1 = Fault active		The inverter has a fault. Acknowledge fault using STW1.7.	p2080[3] = r2139.3
4	1 = OFF2 inactive		Coast down to standstill is not active.	p2080[4] = r0899.4
5	1 = OFF3 inactive		Quick stop is not active.	p2080[5] = r0899.5
6	1 = Switching on inhibited active		It is only possible to switch on the motor after an OFF1 followed by ON.	p2080[6] = r0899.6
7	1 = Alarm active		Motor remains switched on; no acknowledgement is necessary.	p2080[7] = r2139.7
8	1 = Speed deviation within the tolerance range		Setpoint / actual value deviation within the tolerance range.	p2080[8] = r2197.7
9	1 = Master control requested		The automation system is requested to accept the inverter control.	p2080[9] = r0899.9
10	1 = Comparison speed reached or exceeded		Speed is greater than or equal to the corresponding maximum speed.	p2080[10] = r2199.1
11	1 = current or torque limit reached	1 = torque limit reached	Comparison value for current or torque has been reached or exceeded.	p2080[11] = r0056.13 / r1407.7
12	--- ¹⁾	1 = Holding brake open	Signal to open and close a motor holding brake.	p2080[12] = r0899.12
13	0 = Alarm, motor overtemperature		--	p2080[13] = r2135.14

3.1 PROFIDRIVE profile - Cyclic communication

Bit	Significance		Remarks	Signal inter-connection in the in-verter
	Telegram 20	All other tele-grams		
14	1 = Motor rotates clockwise		Internal inverter actual value > 0	p2080[14] = r2197.3
	0 = Motor rotates counter-clockwise		Internal inverter actual value < 0	
15	1 = CDS display	0 = Alarm, in-verter thermal overload		p2080[15] = r0836.0 / r2135.15

1) If you change over from another telegram to telegram 20, then the assignment of the previous telegram is kept.

3.1.1.2 Control and status word 2

Control word 2 is preassigned as follows:

- Bits 0 ... 11 manufacturer-specific
- Bits 12 ... 15 corresponding to the PROFIdrive profile

Status word 2 is preassigned as follows:

- Bits 0 ... 11 manufacturer-specific
- Bits 12 ... 15 corresponding to the PROFIdrive profile

Control word 2 (STW2)

Bit	Meaning		Signal interconnection in the inverter
	Telegrams 2, 3 and 4	Telegrams 9, 110 and 111	
0	1 = drive data set selection DDS bit 0		p0820[0] = r2093.0
1	1 = drive data set selection DDS bit 1		p0821[0] = r2093.1
2...6	Reserved		
7	1 = parking axis is selected		p0897 = r2093.7
8	1 = travel to fixed stop active	Reserved	p1545[0] = r2093.8
9...11	Reserved		
12	1 = master sign-of-life bit 0		p2045 = r2050[3]
13	1 = master sign-of-life bit 1		
14	1 = master sign-of-life bit 3		
15	1 = master sign-of-life bit 4		

Status word 2 (ZSW2)

Bit	Meaning	Signal interconnection in the inverter
0	1 = Drive data set DDS effective, bit 0	p2081[0] = r0051.0
1	1 = Drive data set DDS effective, bit 1	p2081[1] = r0051.1
2...4	Reserved	
5	1 = Alarm class bit 0	p2081[5] = r2139.11
6	1 = alarm class bit 1	p2081[6] = r2139.12
7	Reserved	
8	1 = travel to fixed stop active	p2081[8] = r1406.8
9	Reserved	
10	1 = pulses enabled	p2081[10] = r0899.11
11	Reserved	
12	Slave sign-of-life bit 0	Internally interconnected
13	Slave sign of life bit 1	
14	Slave sign of life bit 2	
15	Slave sign of life bit 3	

3.1.1.3 Control and status word 3

Control word 3 is preassigned as follows:

- Bits 0 ... 15 manufacturer-specific

Status word 3 is preassigned as follows:

- Bits 0 ... 15 manufacturer-specific

Control word 3 (STW3)

Bit	Meaning	Explanation	Signal interconnection in the inverter ¹⁾
	Telegram 350		
0	1 = fixed setpoint bit 0	Selects up to 16 different fixed setpoints.	p1020[0] = r2093.0
1	1 = fixed setpoint bit 1		p1021[0] = r2093.1
2	1 = fixed setpoint bit 2		p1022[0] = r2093.2
3	1 = fixed setpoint bit 3		p1023[0] = r2093.3
4	1 = DDS selection bit 0	Changes over between settings for different motors (drive data sets).	p0820 = r2093.4
5	1 = DDS selection bit 1		p0821 = r2093.5
6	Not used		
7	Not used		
8	1 = technology controller enable	--	p2200[0] = r2093.8
9	1 = enable DC braking	--	p1230[0] = r2093.9
10	Not used		
11	1 = Enable droop	Enable or inhibit speed controller droop.	p1492[0] = r2093.11
12	1 = torque control active 0 = speed control active	Changes over the control mode for vector control.	p1501[0] = r2093.12
13	1 = no external fault 0 = external fault is active (F07860)	--	p2106[0] = r2093.13
14	Not used		
15	1 = CDS bit 1	Changes over between settings for different operation interfaces (command data sets).	p0811[0] = r2093.15

¹⁾ If you switch from telegram 350 to a different one, then the inverter sets all interconnections p1020, ... to "0". Exception: p2106 = 1.

Status word 3 (ZSW3)

Bit	Meaning	Description	Signal interconnection in the inverter
0	1 = DC braking active	--	p2051[3] = r0053
1	1 = $ n_{act} > p1226$	Absolute current speed > stationary state detection	
2	1 = $ n_{act} > p1080$	Absolute actual speed > minimum speed	
3	1 = $i_{act} \geq p2170$	Actual current \geq current threshold value	
4	1 = $ n_{act} > p2155$	Absolute actual speed > speed threshold value 2	
5	1 = $ n_{act} \leq p2155$	Absolute actual speed < speed threshold value 2	
6	1 = $ n_{act} \geq r1119$	Speed setpoint reached	
7	1 = DC link voltage $\leq p2172$	Actual DC link voltage \leq threshold value	
8	1 = DC link voltage > p2172	Actual DC link voltage > threshold value	
9	1 = ramp-up or ramp-down completed	Ramp-function generator is not active.	
10	1 = technology controller output at the lower limit	Technology controller output $\leq p2292$	
11	1 = technology controller output at the upper limit	Technology controller output > p2291	
12	Not used		
13	Not used		
14	Not used		
15	Not used		

3.1.2 NAMUR message word

Fault word according to the VIK-NAMUR definition (MELD_NAMUR)

Table 3- 1 Fault word according to the VIK-NAMUR definition and interconnection with parameters in the inverter

Bit	Significance	P no.
0	1 = Control Unit signals a fault	p2051[5] = r3113
1	1 = line fault: Phase failure or inadmissible voltage	
2	1 = DC link overvoltage	
3	1 = Power Module fault, e.g. overcurrent or overtemperature	
4	1 = inverter overtemperature	
5	1 = ground fault/phase fault in the motor cable or in the motor	
6	1 = motor overload	
7	1 = communication error to the higher-level control system	
8	1 = fault in a safety-relevant monitoring channel	
10	1 = fault in the internal inverter communication	
11	1 = line fault	
15	1 = other fault	

3.1.3 Control and status word, encoder

Telegrams 3 and 4 allow the higher-level control system to directly access the encoder.

Direct access is necessary, if the higher-level control is responsible for the closed-loop position control for the drive.

If you enable the "Basic positioner" position control in the inverter, then telegrams 3 and 4 cannot be selected, and the inverter handles the encoder control.

Control word encoder (G1_STW and G2_STW)

Bit	Meaning	Explanation		Signal interconnection in the inverter
		Bit 7 = 0	Bit 7 = 1	
0	Function 1	1 = search for reference cam 1 with a positive start direction	1 = request flying referencing to the rising edge of reference cam 1	Telegram 3: Encoder 1: p0480[0] = r2050[4]
1	Function 2	1 = search for reference cam 1 with a negative start direction	1 = request flying referencing to the falling edge of reference cam 1	
2	Function 3	1 = search for reference cam 2 with a positive start direction	1 = request flying referencing to the rising edge of reference cam 2	Telegram 4: Encoder 1: p0480[0] = r2050[4] encoder 2: p0480[1] = p2050[9]
3	Function 4	1 = search for reference cam 2 with a negative start direction	1 = request flying referencing to the falling edge of reference cam 2	
4	Command bit 0	1 = activate the function requested using bit 0 ... 3		Telegram 102: Encoder 1: p0480[0] = r2050[5]
5	Command bit 1	1 = read the value requested using bit 0 ... 3		
6	Command bit 2	Reserved		Telegram 103: Encoder 1: p0480[0] = r2050[5] encoder 2: p0480[1] = p2050[10]
7	Mode	1 = flying referencing 0 = search for reference cams		
8	Reserved	---		
... 12				
13	Cyclic absolute value	1 = request for the cyclic transfer of the position actual value in G1_XIST2 or G2_XIST2		
14	Parking	1 = request to park the encoder		
15	Acknowledge	0 → 1 = acknowledge encoder fault		

Status word encoder (G1_ZSW and G2_ZSW)

Bit	Meaning	Explanation		Signal interconnection in the inverter
		Bit 7 = 0	Bit 7 = 1	
0	Function 1	1 = search for reference cam 1 is active	1 = flying referencing to the rising edge of reference cam 1 is active	Telegram 3: Encoder 1: p2051[4] = r0481[0] Telegram 4: Encoder 1: p2051[4] = r0481[0] encoder 2: p2051[9] = r0481[1] Telegram 102: Encoder 1: p2051[5] = r0481[0] Telegram 103: Encoder 1: p2051[5] = r0481[0] encoder 2: p2051[10] = r0481[0]
1	Function 2	1 = search for reference cam 1 is active	1 = flying referencing to the falling edge of reference cam 1 is active	
2	Function 3	1 = search for reference cam 2 is active	1 = flying referencing to the rising edge of reference cam 2 is active	
3	Function 4	1 = search for reference cam 2 is active	1 = flying referencing to the falling edge of reference cam 2 is active	
4	Status value 1	1 = position actual value is at reference cam 1	1 = flying referencing to the rising edge of reference cam 1 has been completed	
5	Status value 2	1 = position actual value is at reference cam 1	1 = flying referencing to the falling edge of reference cam 1 has been completed	
6	Status value 3	1 = position actual value is at reference cam 2	1 = flying referencing to the rising edge of reference cam 2 has been completed	
7	Status value 4	1 = position actual value is at reference cam 2	1 = flying referencing to the falling edge of reference cam 2 has been completed	
8	Reference cam 1	1 = reference cam 1 supplies a high signal 0 = reference cam 1 supplies a low signal		
9	Reference cam 2	1 = reference cam 2 supplies a high signal 0 = reference cam 2 supplies a low signal		
10	Reserved	---		
11	Acknowledge	1 = acknowledge encoder fault is active		
12	Reserved	---		
13	Cyclic absolute value	1 = the position actual value is in G1_XIST2 or G2_XIST2.		
14	Parking	1 = the encoder is parked		
15	Fault	1 = the encoder indicates its actual fault in r0483		

3.1.4 Position actual value of the encoder

G1_XIST1 and G2_XIST1

In the factory setting, the inverter transfers the encoder position actual value with a fine resolution of 11 bits to the higher-level control system.

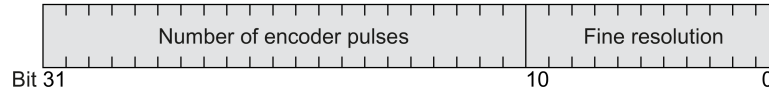

Figure 3-13 G1_XIST1 and G2_XIST1

The transferred encoder signal has the following properties:

- After the inverter power supply has been switched on, the encoder signal = 0.
- The higher-level control must be able to handle a counter overflow of the encoder signal.

G1_XIST2 and G2_XIST2

In G1_XIST2 or G2_XIST2, the inverter transfers different values to the higher-level control system:

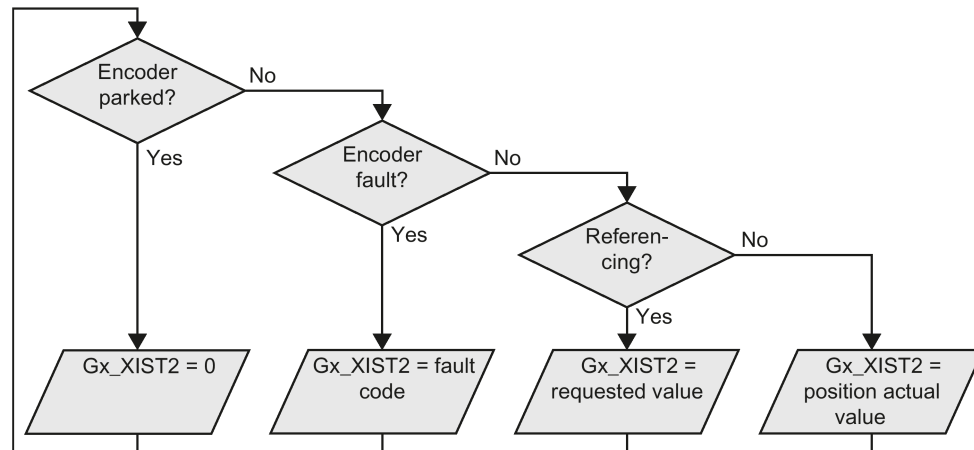

Encoder x parked	Gx_ZSW.14 = 1
Encoder fault x	Gx_ZSW.15 = 1
Referencing encoder x	Gx_ZSW.4 = 1 or Gx_ZSW.5 = 1 or Gx_ZSW.6 = 1 or Gx_ZSW.7 = 1

Figure 3-14 G1_XIST2 and G2_XIST2

3.1 PROFIDRIVE profile - Cyclic communication

The inverter transfers the position values in the same format (encoder pulse number and fine resolution) the same as G1_XIST1 and G2_XIST1.

Table 3- 2 Fault code

No.	Explanation	Possible cause
1	Encoder fault	One or more encoder faults. Observe the inverter message.
2	Zero-mark monitoring	---
3	Encoder parking canceled	Parking was already requested.
4	Search for reference canceled	<ul style="list-style-type: none"> • Encoder has no zero mark (reference mark). • Reference mark 2, 3 or 4 was requested. • Switchover to "Flying measurement" was requested during search for reference. • Command "Read value x" requested during search for reference mark. • Inconsistent position measured value with distance-coded reference marks.
5	Retrieve reference value canceled	<ul style="list-style-type: none"> • More than four values were requested. • No value requested. • Requested value is not available.
6	Flying referencing canceled	<ul style="list-style-type: none"> • Reference cam has not been configured • During "Flying referencing" a changeover was made to search for reference. • During "Flying referencing" a request was issued "Read value x".
7	Retrieve measured value canceled	<ul style="list-style-type: none"> • More than one value was requested. • No value requested. • Requested value is not available. • Encoder is parked.
8	Position actual value transfer canceled	<ul style="list-style-type: none"> • No absolute encoder available. • Alarm bit in the absolute value protocol set.
3841	Encoder does not support the function	---

3.1.5 Extend telegrams and change signal interconnection

Overview

When you have selected a telegram, the inverter interconnects the corresponding signals with the fieldbus interface. Generally, these interconnections are locked so that they cannot be changed. However, with the appropriate setting in the inverter, the telegram can be extended or even freely interconnected.

Extending the telegram

Procedure

1. Set p0922 = 999.
2. Set parameter p2079 to the value of the corresponding telegram.

The interconnections contained in the telegram are locked.

3. Extend the telegram by "attaching" additional signals.

Interconnect additional PZD send words and PZD receive words with signals of your choice via parameters r2050 and p2051.

You have extended the telegram.



Freely interconnecting signals in the telegram

Procedure

1. Set p0922 = 999.
2. Set p2079 = 999.

The interconnections contained in the telegram are enabled.

3. Interconnect additional PZD send words and PZD receive words with signals of your choice via parameters r2050 and p2051.

You have freely interconnected the signals transferred in the telegram.



Parameter

Parameter	Description
p0922	PROFIdrive telegram selection
	999: Free telegram (message frame) configuration
p2079	PROFIdrive PZD telegram selection extended
	The following values apply if you have still not enabled the "Basic positioner" function in the inverter:
	1: Standard telegram 1, PZD-2/2
	2: Standard telegram 2, PZD-4/4
	3: Standard telegram 3, PZD-5/9
	4: Standard telegram 4, PZD-6/14
	20: Standard telegram 20, PZD-2/6
	350: SIEMENS telegram 350, PZD-4/4
	352: SIEMENS telegram 352, PZD-6/6
	353: SIEMENS telegram 353, PZD-2/2, PKW-4/4
354: SIEMENS telegram 354, PZD-6/6, PKW-4/4	
999: Free telegram configuration	
p2079	The following values apply if you have enabled the "Basic positioner" function in the inverter:
	7: Standard telegram 7, PZD-2/2
	9: Standard telegram 9, PZD-10/5
	110: SIEMENS telegram 110, PZD-12/7
	111: SIEMENS telegram 111, PZD-12/12
	999: Free telegram configuration
r2050[0...11]	PROFIdrive PZD receive word Received PZD (setpoints) in the word format
p2051[0...16]	PROFIdrive PZD send word Sent PZD (actual values) in the word format

For further information about receive and send words, refer to the function block diagrams 2468 and 2470 in the List Manual.



Overview of the manuals (Page 232)

3.1.6 Data structure of the parameter channel

Structure of the parameter channel

The parameter channel consists of four words. The 1st and 2nd words transfer the parameter number, index and the type of task (read or write). The 3rd and 4th words contain the parameter content. The parameter contents can be 16-bit values (such as baud rate) or 32-bit values (e.g. CO parameters).

Bit 11 in the 1st word is reserved and is always assigned 0.

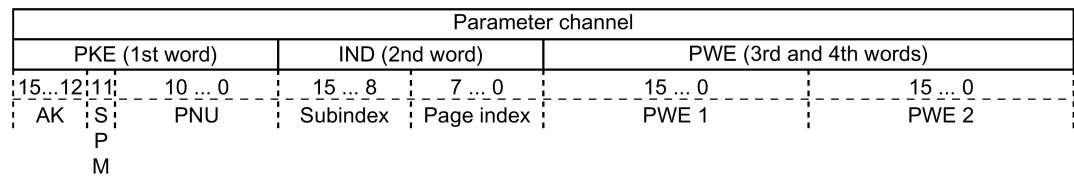

You can find application examples relating to the parameter channel at the end of this section.

AK: Request and response IDs

Bits 12 ... 15 of the 1st The parameter channel words contain the request and response identifier AK.

Table 3- 3 Request identifiers, control → inverter

AK	Description	Response identifier	
		positive	negative
0	No request	0	7 / 8
1	Request parameter value	1 / 2	7 / 8
2	Change parameter value (word)	1	7 / 8
3	Change parameter value (double word)	2	7 / 8
4	Request descriptive element ¹⁾	3	7 / 8
6 ²⁾	Request parameter value (field) ¹⁾	4 / 5	7 / 8
7 ²⁾	Change parameter value (field, word) ¹⁾	4	7 / 8
8 ²⁾	Change parameter value (field, double word) ¹⁾	5	7 / 8
9	Request number of field elements	6	7 / 8

¹⁾ The required element of the parameter is specified in IND (2nd word).

²⁾ The following request IDs are identical: 1 ≡ 6, 2 ≡ 7 3 ≡ 8.
 We recommend that you use identifiers 6, 7, and 8.

Table 3- 4 Response identifiers, inverter → control

AK	Description
0	No response
1	Transfer parameter value (word)
2	Transfer parameter value (double word)
3	Transfer descriptive element ¹⁾
4	Transfer parameter value (field, word) ²⁾
5	Transfer parameter value (field, double word) ²⁾
6	Transfer number of field elements
7	Inverter cannot process the request. In the most significant word of the parameter channel, the inverter sends an error number to the control, refer to the following table.
8	No master controller status / no authorization to change parameters of the parameter channel interface

1) The required element of the parameter is specified in IND (2nd word).

2) The required element of the indexed parameter is specified in IND (2nd word).

Table 3- 5 Error numbers for response identifier 7

No.	Description
00 hex	Illegal parameter number (access to a parameter that does not exist)
01 hex	Parameter value cannot be changed (change request for a parameter value that cannot be changed)
02 hex	Lower or upper value limit exceeded (change request with a value outside the value limits)
03 hex	Incorrect subindex (access to a subindex that does not exist)
04 hex	No array (access with a subindex to non-indexed parameters)
05 hex	Incorrect data type (change request with a value that does not match the data type of the parameter)
06 hex	Setting not permitted, only resetting (change request with a value not equal to 0 without permission)
07 hex	Descriptive element cannot be changed (change request to a descriptive element error value that cannot be changed)
0B hex	No master control (change request but with no master control, see also p0927.)
0C hex	Keyword missing
11 hex	Request cannot be executed due to the operating state (access is not possible for temporary reasons that are not specified)
14 hex	Inadmissible value (change request with a value that is within the limits but which is illegal for other permanent reasons, i.e. a parameter with defined individual values)
65 hex	Parameter number is currently deactivated (depending on the mode of the inverter)
66 hex	Channel width is insufficient (communication channel is too small for response)
68 hex	Illegal parameter value (parameter can only assume certain values)
6A hex	Request not included / task is not supported (the valid request identifications can be found in table "Request identifications controller → inverter")
6B hex	No change access for a controller that is enabled. (The operating state of the inverter prevents a parameter change)
86 hex	Write access only for commissioning (p0010 = 15) (operating state of the inverter prevents a parameter change)
87 hex	Know-how protection active, access locked
C8 hex	Change request below the currently valid limit (change request to a value that lies within the "absolute" limits, but is however below the currently valid lower limit)
C9 hex	Change request above the currently valid limit (example: a parameter value is too large for the inverter power)
CC hex	Change request not permitted (change is not permitted as the access code is not available)

PNU (parameter number) and page index

The parameter number is located in value PNU in the 1st word of the parameter channel (PKE).

The page index is located in the 2nd word of the parameter channel (IND bit 7 ... 0).

Parameter number	PNU	Page index
0000 ... 1999	0000 ... 1999	0 hex
2000 ... 3999	0000 ... 1999	80 hex
6000 ... 7999	0000 ... 1999	90 hex
8000 ... 9999	0000 ... 1999	20 hex
10000 ... 11999	0000 ... 1999	A0 hex
20000 ... 21999	0000 ... 1999	50 hex
30000 ... 31999	0000 ... 1999	F0 hex
60000 ... 61999	0000 ... 1999	74 hex

Subindex

For indexed parameters, the parameter index is located in subindex (IND Bit 15 ... 8) as hexadecimal value.

PWE: Parameter value or connector

Parameter values or connectors can be located in the PWE.

Table 3- 6 Parameter value or connector

	PWE 1	PWE 2	
Parameter value	Bit 15 ... 0	Bit 15 ... 8	Bit 7 ... 0
	0	0	8-bit value
	0	16-bit value	
	32-bit value		
Connector	Bit 15 ... 0	Bit 15 ... 10	Bit 9 ... 0
	Number of the connector	3F hex	The index or bit field number of the connector

Write request: Assign digital input 2 with the function ON/OFF1 (p0840[1] = 722.2)

In order to link digital input 2 with ON/OFF1, you must assign parameter p0840[1] (source, ON/OFF1) the value 722.2 (DI 2). To do this, you must populate the telegram of the parameter channel as follows:

- **PKE, bit 12 ... 15 (AK): = 7 hex** (change parameter value (field, word))
- **PKE, bit 0 ... 10 (PNU): = 348 hex** (840 = 348 hex, no offset, as 840 < 1999)
- **IND, bit 8 ... 15 (subindex): = 1 hex** (CDS1 = Index 1)
- **IND, bit 0 ... 7 (page index): = 0 hex** (offset 0 corresponds to 0 hex)
- **PWE1, Bit 0 ... 15: = 2D2 hex** (722 = 2D2 hex)
- **PWE2, Bit 10 ... 15: = 3F hex** (drive object - for SINAMICS G120, always 63 = 3f hex)
- **PWE2, Bit 0 ... 9: = 2 hex** (Index of Parameter (DI 2 = 2))

Parameter channel																																																																			
PKE, 1st word				IND, 2nd word				PWE1 - high, 3rd word				PWE2 - low, 4th word																																																							
15...12	11	10 ... 0		15 ... 8	7 ... 0			15 ... 0				15 ... 10	9 ... 0																																																						
AK		Parameter number		Subindex	Page index			Parameter value				Drive Object	Index																																																						
0	1	1	1	0	0	1	1	0	1	0	1	0	0	1	0	0	0	0	0	0	0	0	0	0	1	0	0	0	0	0	0	0	0	0	0	0	0	0	0	0	1	0	1	0	1	0	1	0	0	1	0	1	1	1	1	1	0	0	0	0	0	0	0	0	0	1	0

Figure 3-17 Telegram, to assign DI 2 with ON/OFF1

Application example, "Read and write to parameters"

Further information is provided on the Internet:



Application examples (<https://support.industry.siemens.com/cs/ww/en/view/29157692>)

3.1.7 Slave-to-slave communication

"Direct data exchange" is sometimes called "slave-to-slave communication" or "data exchange broadcast". Here, slaves exchange data without any direct involvement of the master.

Example: An inverter uses the actual speed value of another inverter as its speed setpoint.

Definitions

- **Publisher:** Slave, which sends data for direct data exchange.
- **Subscriber:** Slave, which receives the data for direct data exchange from the publisher.
- **Links and access points** define the data that is used for direct data exchange.

Restrictions

- Direct data exchange in the current firmware version is only possible for inverters with PROFIBUS communication.
- A maximum of 12 PZDs are permissible for each drive.
- A maximum of four links are possible from one subscriber to one or several publishers.

Configuring slave-to-slave communication

Procedure

1. In the control, define:
 - Which inverters operate as publisher (sender) or subscriber (receiver)?
 - Which data or data areas do you use for direct data exchange?
2. In the inverter, define:
 - How does the subscriber process the data transferred using direct data exchange?

You have now configured slave-to-slave communication.

□

3.2 PROFIDRIVE profile - Acyclic communication

The inverter supports the following types of acyclic communication:

- For PROFIBUS:
acyclic communication via data set 47
- For PROFINET:
acyclic communication via B02E hex and B02F hex

The maximum data length per request is 240 bytes.

Note

Values in italics

Values in italics in the following tables mean that you have to adjust these values for a specific request.

Reading parameter values

Table 3- 7 Request to read parameters

Data block	Byte n	Bytes n + 1	n
Header	Reference <i>00 hex ... FF hex</i>	01 hex: Read job	0
	01 hex (ID of drive objects, at G120 always = 1)	Number of parameters (m)	2
Address, parameter 1	Attribute <i>10 hex:</i> Parameter value <i>20 hex:</i> Parameter description	Number of the indices <i>00 hex ... EA hex</i> (For parameters without index: 00 hex)	4
	Parameter number <i>0001 hex ... FFFF hex</i>		6
	Number of the 1st index <i>0000 hex ... FFFF hex</i> (for parameters without index: 0000 hex)		8

Address, parameter 2
...
Address, parameter m

Table 3- 8 Inverter response to a read request

Data block	Byte n	Bytes n + 1	n
Header	Reference (identical to a read request)	01 hex: Inverter has executed the read request. 81 hex: Inverter was not able to completely execute the read request.	0
	01 hex (ID of drive objects, at G120 always = 1)	Number of parameters (m) (identical to the read request)	2
Values, parameter 1	Format 02 hex: Integer8 03 hex: Integer16 04 hex: Integer32 05 hex: Unsigned8 06 hex: Unsigned16 07 hex: Unsigned32 08 hex: FloatingPoint 0A hex: OctetString 0D hex: TimeDifference 34 hex: TimeOfDay without date indication 35 hex: TimeDifference with date indication 36 hex: TimeDifference without date indication 41 hex: Byte 42 hex: Word 43 hex: Double word 44 hex: Error	Number of index values or - for a negative response - number of error values	4
	Value of the 1st index or - for a negative response - error value 1 You can find the error values in a table at the end of this section.		6

Values, parameter 2	...		
...	...		
Values, parameter m	...		

Changing parameter values

Table 3- 9 Request to change parameters

Data block	Byte n	Bytes n + 1	n
Header	Reference 00 hex ... FF hex	02 hex: Change request	0
	01 hex (ID of drive objects, at G120 always = 1)	Number of parameters (m) 01 hex ... 27 hex	2
Address, parameter 1	10 hex: Parameter value	Number of indices 00 hex ... EA hex (00 hex and 01 hex are equivalents)	4
	Parameter number 0001 hex ... FFFF hex		6
	Number of the 1st index 0001 hex ... FFFF hex		8

Address, parameter 2	...		
...
Address, parameter m	...		
Values, parameter 1	Format 02 hex: Integer 8 03 hex: Integer 16 04 hex: Integer 32 05 hex: Unsigned 8 06 hex: Unsigned 16 07 hex: Unsigned 32 08 hex: Floating Point 0A hex: Octet String 0D hex: Time Difference 34 hex: TimeOfDay without date indication 35 hex: TimeDifference with date indication 36 hex: TimeDifference without date indication 41 hex: Byte 42 hex: Word 43 hex: Double word	Number of index values 00 hex ... EA hex	
	Value of the 1st index		
	...		
Values, parameter 2	...		
...	...		
Values, parameter m	...		

Table 3- 10 Response, if the inverter has executed the change request

Data block	Byte n	Bytes n + 1	n
Header	Reference (identical to a change request)	02 hex (change request successful)	0
	01 hex (ID of drive objects, at G120 always = 1)	Number of parameters (identical to a change request)	2



Table 3- 11 Response if the inverter was not able to completely execute the change request

Data block	Byte n	Bytes n + 1	n
Header	Reference (identical to a change request)	82 hex: (Inverter was not able to completely execute the write request)	0
	01 hex (ID of drive objects, at G120 always = 1)	Number of parameters (identical to a change request)	2
Values, parameter 1	Format 40 hex: Zero (change request for this data block executed) 44 hex: Error (change request for this data block not executed)	Number of error values 00 hex 01 hex or 02 hex	4
	Only for "Error" - error value 1 You can find the error values in the table at the end of this section.		6
	Only for "Error" - error value 2 Error value 2 is either zero, or it contains the number of the first index where the error occurred.		8
Values, parameter 2	...		
...
Values, parameter m	...		

Error values

Table 3- 12 Error value in the parameter response

Error value 1	Meaning
00 hex	Illegal parameter number (access to a parameter that does not exist)
01 hex	Parameter value cannot be changed (change request for a parameter value that cannot be changed)
02 hex	Lower or upper value limit exceeded (change request with a value outside the value limits)
03 hex	Incorrect subindex (access to a parameter index that does not exist)
04 hex	No array (access with a subindex to non-indexed parameters)
05 hex	Incorrect data type (change request with a value that does not match the data type of the parameter)
06 hex	Setting not permitted, only resetting (change request with a value not equal to 0 without permission)
07 hex	Descriptive element cannot be changed (change request to a descriptive element that cannot be changed)
09 hex	Description data not available (access to a description that does not exist, parameter value is available)
0B hex	No master control (change request but with no master control)
0F hex	Text array does not exist (although the parameter value is available, the request is made to a text array that does not exist)
11 hex	Request cannot be executed due to the operating state (access is not possible for temporary reasons that are not specified)
14 hex	Inadmissible value (change request with a value that is within the limits but which is illegal for other permanent reasons, i.e. a parameter with defined individual values)
15 hex	Response too long (the length of the actual response exceeds the maximum transfer length)
16 hex	Illegal parameter address (illegal or unsupported value for attribute, number of elements, parameter number, subindex or a combination of these)
17 hex	Illegal format (change request for an illegal or unsupported format)

Error value 1	Meaning
18 hex	Number of values not consistent (number of values of the parameter data to not match the number of elements in the parameter address)
19 hex	Drive object does not exist (access to a drive object that does not exist)
20 hex	Parameter text cannot be changed
21 hex	Service is not supported (illegal or not support request ID).
6B hex	A change request for a controller that has been enabled is not possible. (The inverter rejects the change request because the motor is switched on. Please observe the "Can be changed" parameter attribute (C1, C2, U, T) in the List Manual.  Manuals and technical support (Page 232))
6C hex	Unknown unit.
6E hex	Change request is only possible when the motor is being commissioned (p0010 = 3).
6F hex	Change request is only possible when the power unit is being commissioned (p0010 = 2).
70 hex	Change request is only possible for quick commissioning (basic commissioning) (p0010 = 1).
71 hex	Change request is only possible if the inverter is ready (p0010 = 0).
72 hex	Change request is only possible for a parameter reset (restore to factory setting) (p0010 = 30).
73 hex	Change request possible only during commissioning of the safety functions (p0010 = 95).
74 hex	Change request is only possible when a technological application/unit is being commissioned (p0010 = 5).
75 hex	Change request is only possible in a commissioning state (p0010 ≠ 0).
76 hex	Change request is not possible for internal reasons (p0010 = 29).
77 hex	Change request is not possible during download.
81 hex	Change request is not possible during download.
82 hex	Accepting the master control is inhibited via BI: p0806.
83 hex	Desired interconnection is not possible (the connector output does not supply a float value although the connector input requires a float value)
84 hex	Inverter does not accept a change request (inverter is busy with internal calculations. See parameter r3996 in the inverter List Manual.  Manuals and technical support (Page 232))
85 hex	No access methods defined.
86 hex	Write access only during commissioning of the data records (p0010 = 15) (operating status of the inverter prevents a parameter change.)
87 hex	Know-how protection active, access locked
C8 hex	Change request below the currently valid limit (change request to a value that lies within the "absolute" limits, but is however below the currently valid lower limit)
C9 hex	Change request above the currently valid limit (example: a parameter value is too large for the inverter power)
CC hex	Change request not permitted (change is not permitted as the access code is not available)

3.3 PROFIdrive profile - Diagnostic channels

The inverters provide the diagnostics standardized for PROFIBUS and PROFINET. This means that it is possible to directly output faults and alarms at an HMI (control system screen).

Here, PROFINET offers more functions than PROFIBUS

- PROFIBUS: Faults without component assignment
- PROFINET: Faults and alarms with component assignment

The fault and alarm messages are saved in the inverter in the following parameters

- r0947[0 ... 63]: Fault number
- r2122[0 ... 63]: Alarm code
- r3120[0 ... 63]: Components which are involved with the fault (only for PROFINET)
- r3121[0 ... 63]: Components which are involved with the alarm (only for PROFINET)

The inverter transfers the messages in the sequence in which they occurred

The control generates the time stamp when the messages are received

3.3.1 Diagnostics with PROFINET

PROFINET uses the channel diagnostics to transfer PROFIdrive message classes.

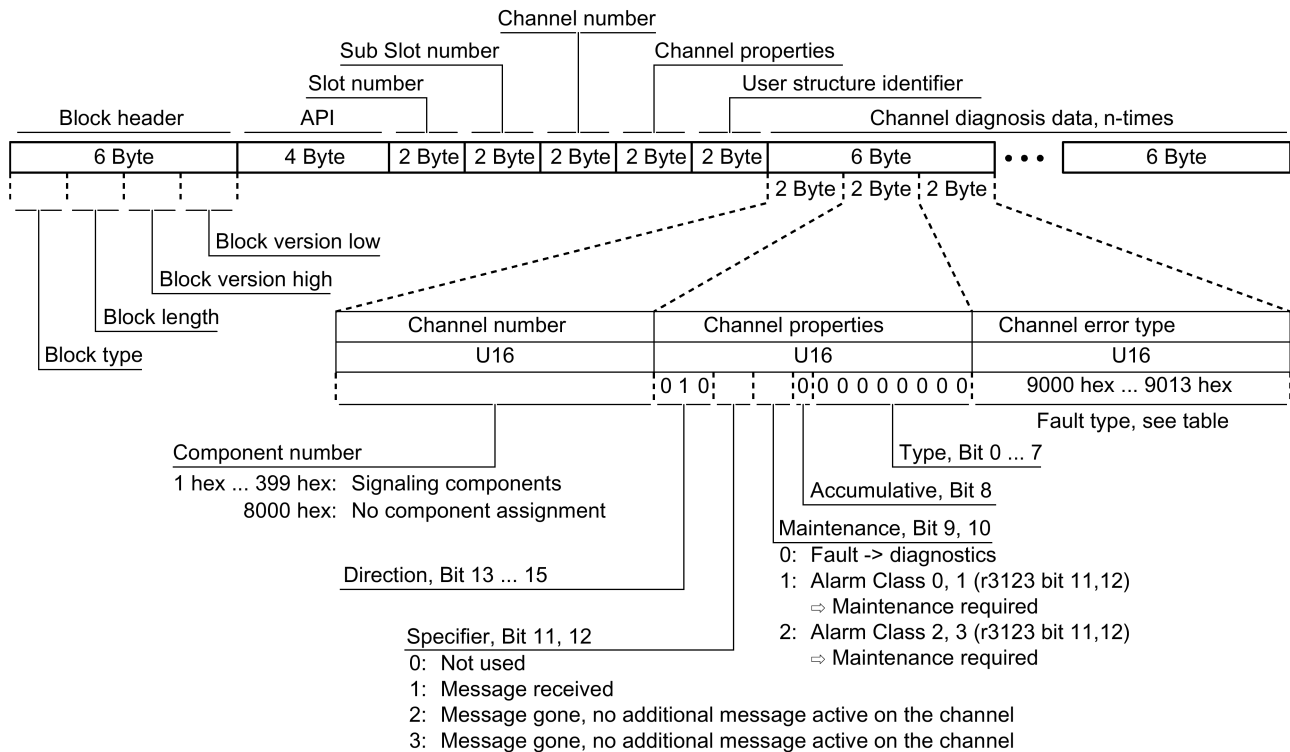

9000 hex	Hardware/software error	900A hex	Position/speed actual value incorrect or not available
9001 hex	Network fault	900B hex	Internal (DRIVE-CLiQ) communication error
9002 hex	Supply voltage fault	900C hex	Infeed faulted
9003 hex	DC link overvoltage	900D hex	Braking module faulted
9004 hex	Power electronics faulted	900E hex	Line filter faulted
9005 hex	Overtemperature of the electronic components	900F hex	External measured value / signal state outside the permissible range
9006 hex	Ground fault / inter-phase short circuit	9010 hex	Application / technological function faulted
9007 hex	Motor overload	9011 hex	Error in the parameterization / configuration / commissioning procedure
9008 hex	Communication error to the higher-level control system	9012 hex	General drive fault
9009 hex	Safety monitoring channel has identified an error	9013 hex	Auxiliary unit faulted

Figure 3-18 Structure of the channel diagnostics

Reading out diagnostics data

The control requests the diagnostics data from the inverter using "Read data set", e.g. using a read record with index 800C hex.

The following rules apply:

- 1 Message block (=ChannelDiagnosisData)
if (one or several) faults of the same message class are detected at the inverter
- n message blocks
if at the inverter, n faults of different message classes are detected



Further information is provided in the Internet: To access this link, you must be a member of PROFIBUS and PROFINET International (PI).

PROFINET IO specification (<http://www.profibus.com/nc/download/specifications-standards/downloads/profinet-io-specification/display/>)

3.3.2 Diagnostics with PROFIBUS

The following objects belonging to a diagnostics message in PROFIBUS

- **Standard diagnostics**
 - Sequence: always at the first position of the message
 - Length is always 6 bytes
- **Identifier-related diagnostics**
 - Sequence: at the second, third or fourth position
 - Identification using the header,
 - For SINAMICS G120, the length is always 2 bytes
- **Status messages/module status**
 - Sequence: at the second, third or fourth position
 - Identification using the header,
 - Length for SINAMICS G120:
 - 5 bytes for configuration using GSD
 - 6 bytes when configuring using the object library
- **Channel-related diagnostics**
 - Sequence: at the second, third or fourth position
 - Identification using the header,
 - Length is always 3 bytes
- **Diagnostics alarm with DS0 / DS1**
 - Sequence: always at the last position of the message
 - Slot-specific the actual state of the slot responsible for the message is transferred.

Note

Precondition for diagnostics via PROFIBUS

The master must operate in the DPV1 mode for diagnostics via Profibus.

Default diagnostics

Byte No.	Name	Bit							
		7	6	5	4	3	2	1	0
1	Station status 1	Master_Lock = 0	Prm_Fault	0	Not supported	Ext_Diag	Cfg_Fault	Station_not_Ready	Station_Non_Exist = 0
2	Station status 2	0	0	Sync_Mode	Freeze_Mode	WD_ON	0	Start_Diag = 0	Prm_Req
3	Station status 3	Ext_Diag_Overflow	0	0	0	0	0	0	0
4		Master_Add							
5		Ident_Number (HighByte) of the slave							
6		Ident_Number (LowByte) of the slave							

The following values are decisive for the diagnostics:

- **Ext_Diag:** Group signal for diagnostics in the slave:
 - 0: No fault is active
 - 1: At least one alarm or fault is active
- **Ext_Diag_Overflow:**
 - Display for the diagnostics overflow in the slave (for more than 240 bytes)

Identifier-related diagnostics

Byte No.	Name	Bit							
		7	6	5	4	3	2	1	0
1	Header byte	Header 0 1		Block length 2 ... 32 For SINAMICS G120 always = 2					
2	Bit structure	KB_7	KB_6	KB_5	KB_4	KB_3	KB_2	KB_1	KB_0
	
m	Bit structure	KB_n+1	KB_n

The identifier-related diagnostics provides a bit (KB_n) for each slot allocated when configuring the device. If a diagnostics message is active at a slot, then it's KB_n = 1.

For G120 only one slot is allocated:

- KB_0 when configuring with the GSD
- KB_3 when configuring with the object manager

Status messages, module status

Byte No.	Name	Bit							
		7	6	5	4	3	2	1	0
1	Header byte	Header 0 0		Block length 2 ... 32 For SINAMICS G120 = 5 or 6					
2	Module status	82 hex (status block)							
3	Slot	0							
4	Specifier	0							
5	Slot structure	Slot_4		Slot_3		Slot_2		Slot_1	
• • • • • • • • • •									
m	Slot structure	...		Slot n		

For G120, independent of the status, for all slots “00” is always output, i.e. valid user data.

Channel-related data

Byte No.	Name	Bit							
		7	6	5	4	3	2	1	0
n	Header byte	Header 1 0		Module number 0 ... 63					
n+1	Bit structure	Input / Output 1 1		0 - no component assignment					
n+2	Bit structure	Channel type - unspecific 0 0 0			Message classes, see the following table				

- | | | | |
|----|--------------------------------|----|---------------------------------|
| 2 | Undervoltage | 22 | Motor overload |
| 3 | Overvoltage | 23 | Commun. with controller faulted |
| 9 | Error | 24 | Safety monit. Detected an error |
| 16 | Hardware/software error | 25 | Act. Position/speed value error |
| 17 | Line supply/filter faulted | 26 | Internal communication faulted |
| 18 | DC link overvoltage | 27 | Infeed faulted |
| 19 | Power electronics faulted | 28 | Braking controller faulted |
| 20 | Electronic component overtemp. | 29 | External signal state error |
| 21 | Ground/phase fault detected | 30 | Application/function faulted |

When several faults are allocated at one inverter with the same message class, then only one message is displayed.

Diagnostics alarm with DS0 / DS1

Byte No.	Name	Bit							
		7	6	5	4	3	2	1	0
1	Header bytes	Header		Block length = 15					
2		0	Diagnostics alarm = 1						
3		0	Slot number 0 ... 244 For SINAMICS G120 1 or 4: Configuration via GSD = 1 Configuration via library = 4						
4		0	0 ... 31, sequence number				Add_Ack	Alarm Specifier ¹⁾	
5	DS0 byte 0	0	0	0	0	0 ²⁾	0	0 ³⁾	0 ⁴⁾
6	DS0 byte 1	0	0	0	1 ⁵⁾	0 ⁶⁾	0 ⁶⁾	0 ⁶⁾	0 ⁶⁾
7	DS0 byte 2	0	0	0	0	0	0	0	0
8	DS0 byte 3	0	0	0	0	0	0	0	0
9	Info byte 1	Mixed	= 45 hex (ChannelTypeID = SINAMICS)						
10	Info byte 2	= 24 (diagnostic bits / channel)							
11	Info byte 3	= 1 (one channel signals)							
12	Channel Error Vector	0	0	0	0	0	0	0	1
13	Channel-related diagnostics (channel 0)	Err 7	Err 6	Err 5	Err 4	Err 3	Err 2	Err 1	Err 0
14		Err 15	Err 14	Err 13	Err 12	Err 11	Err 10	Err 9	Err 8
15		0	0	0	0	Err 19	Err 18	Err 17	Err 16

- | | |
|---|--|
| <p>1) Alarm specifier
 1: Fault is active and the slot is not OK
 2: Fault is resolved and the slot is OK
 3: Fault is resolved and the slot is not OK</p> <p>2) Channel fault present
 0: No fault is active
 1: Fault is active</p> <p>3) Internal fault
 0: No fault is active
 1: Fault is active</p> | <p>4) Module fault
 0: No fault is active
 1: Fault is active</p> <p>5) Channel information present
 1: DS1 exists</p> <p>6) Type of class module = 0011 (distributed)</p> |
|---|--|

A table with the message classes is provided in the List Manual of the inverter.



Overview of the manuals (Page 232)

3.4 Identification & maintenance data (I&M)

I&M data

The inverter supports the following identification and maintenance (I&M) data.

I&M data	Format	Explanation	Associated parameters	Example for the content
I&M0	u8[64] PROFIBUS u8[54] PROFINET	Inverter-specific data, read only	-	See below
I&M1	Visible String [32]	Plant/system identifier	p8806[0 ... 31]	"ak12- ne.bo2=fu1"
	Visible String [22]	Location code	p8806[32 ... 53]	"sc2+or45"
I&M2	Visible String [16]	Date	p8807[0 ... 15]	"2013-01-21 16:15"
I&M3	Visible String [54]	Any comment	p8808[0 ... 53]	-
I&M4	Octet String[54]	Check signature to track changes for Safety Integrated. This value can be changed by the user. The test signature is reset to the value generated by the machine is p8805 = 0 is used.	p8809[0 ... 53]	Values of r9781[0] and r9782[0]

When requested, the inverter transfers its I&M data to a higher-level control or to a PC/PG with installed STEP 7 or TIA Portal.

I&M0

Designation	Format	Example for the content	Valid for PROFINET	Valid for PROFIBUS
Manufacturer-specific	u8[10]	00 ... 00 hex	---	✓
MANUFACTURER_ID	u16	42d hex (=Siemens)	✓	✓
ORDER_ID	Visible String [20]	„6SL3246-0BA22-1FA0“	✓	✓
SERIAL_NUMBER	Visible String [16]	„T-R32015957“	✓	✓
HARDWARE_REVISION	u16	0001 hex	✓	✓
SOFTWARE_REVISION	char, u8[3]	„V“ 04.70.19	✓	✓
REVISION_COUNTER	u16	0000 hex	✓	✓
PROFILE_ID	u16	3A00 hex	✓	✓
PROFILE_SPECIFIC_TYPE	u16	0000 hex	✓	✓
IM_VERSION	u8[2]	01.02	✓	✓
IM_SUPPORTED	bit[16]	001E hex	✓	✓

3.5 S7 communication

Communication via the S7 protocol facilitates the following:

- Access to the inverter with Startdrive.
- Remote maintenance of the inverter with Startdrive across network boundaries.



Remote maintenance across network boundaries

(<https://support.industry.siemens.com/cs/ww/en/view/97550333>)

- Control of the inverter directly via SIMATIC Panels via PROFIBUS or PROFINET without higher-level control.



Directly accessing a SINAMICS G120 converter from a SIMATIC panel (Page 55)

Note

Number of S7 protocol connections

The inverter supports four S7 protocol connections. Two of these are required for Startdrive. Each of the remaining two are available for access to the inverter via SIMATIC Panels.

3.5.1 Directly accessing a SINAMICS G120 converter from a SIMATIC panel

Example of direct access to the inverter via a SIMATIC panel

You want to use the SIMATIC panel to do the following:

- Switch the inverter on and off
- Enter a setpoint
- Display the actual value and status

Requirements

You have installed the following software packages on your computer and made the following settings:

- WINCCflex 2008 SP1 or higher
- Startdrive
- You have configured the inverter in Startdrive
- Inverter and panel are connected with one another via PROFIBUS or PROFINET.
- The same baud rates are set in the inverter and in the panel.
- The bus address configured in WinCC flexible matches the bus address of the inverter.

Adjusting settings in the inverter

Procedure

1. **Make the following settings and releases so that the inverter can accept commands from the panel:**
 - Set the two signal sources for OFF2 (p0844 and p0845) to 1:
p0844 = 1
p0845 = 1
 - Set the two signal sources for OFF3 (p0848 and p0849) to 1:
p0848 = 1
p0849 = 1
 - Set the releases for the ramp-up encoder
p1140 = 1
p1141 = 1
 - Set the setpoint release
p1142 = 1
2. **Adjust the parameters for the ON/OFF1 command from the SIMATIC panel**
 - Set p0840[0] = 2094.0
In doing so, you connect up the ON/OFF1 command using the Bit 0 of the BiCo transformer 2094. The signal source for this parameter is p2099.
 - Now set p2099[0] = p2900
In doing so, you give the ON/OFF1 command by setting P2900 = 1 (ON) or 0 (OFF1)
3. **Set parameters for the setpoint default**
 - Set
P1070 = 1001 (fixed setpoint 1 as setpoint)
P1016 = 1 (direct selection of the speed setpoint)
P1020 = 1 (speed fixed setpoint selection, Bit 0)
4. **Actual value and status word**

No further settings are required by the inverter for displaying the speed list value (r0021) and the status word (r0052).

You have now made the settings in the inverter.

□

Settings at the SIMATIC panel

Procedure

1. Configure the connection using WinCC flexible

- Enter a name for the connection
- Set the value in the "Active" column to "On"
- Select "**SIMATIC S7 300/400**" as the communication driver.
- Set the value in the "Online" column to "On"

2. Make the following settings for the configured connection:

- Select the interface (IF1 B for PROFIBUS, "Ethernet" for PROFINET)
- Set the baud rate for PROFIBUS
- Assign a bus address (PROFIBUS) or an IP address (PROFINET)
- Select S7ONLINE as the access point
- If no other control is connected to the inverter, select "Only master on bus"
- Select cyclical operation.

3. ON/OFF1:

- Create a variable for the parameter p2900, which refers to the address "Data module 2900 with the data word DBD 0 (data type double word)":
DB2900.DBD 0

You can switch ON/OFF1 on the panel using one or two buttons.

4. Setpoint

- Create a variable for the parameter 1001, which refers to the address "Data module 1001 with the data word DBD 0 (data type real)":
DB1001.DBD 0

You can display it through an I/O field.

5. Actual value display

- Create a variable for the parameter r0021, which refers to the address "Data module 21 with the data word DBD 0 (data type real)":
DB21.DBD 0

You can display it through an I/O field.

6. Status display

- Create a variable for the parameter r0052, which refers to the address "Data module 52 with the data word DBW 0 (data type word)":
DB52.DBW 0

You can display it through an I/O field with a binary display, for example.

You have now made the most important settings in the SIMATIC panel.



General information for accessing inverter parameters

You must create a variable with the following structure for each parameter that you want to display or change using the SIMATIC panel: DBX DBY Z

- X: Data module number \triangleq Parameter number
- Y: Data type (can be found in the parameter list)
- Z: Data module offset \triangleq Parameter index

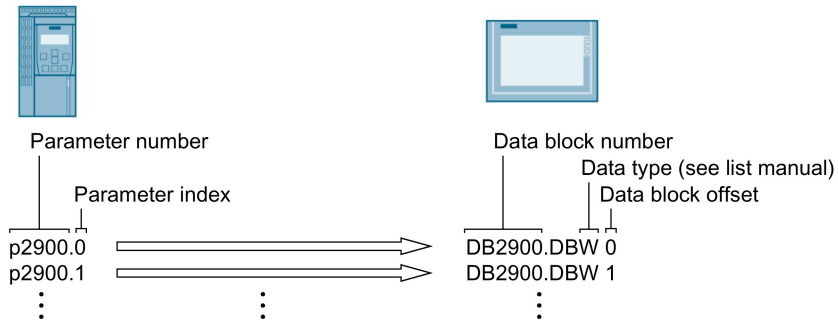

Figure 3-19 Accessing inverter parameters using a SINAMICS G120 as example

3.6 Communication via PROFINET

You can either integrate the inverter in a PROFINET network or communicate with the inverter via Ethernet.

The inverter in PROFINET IO operation

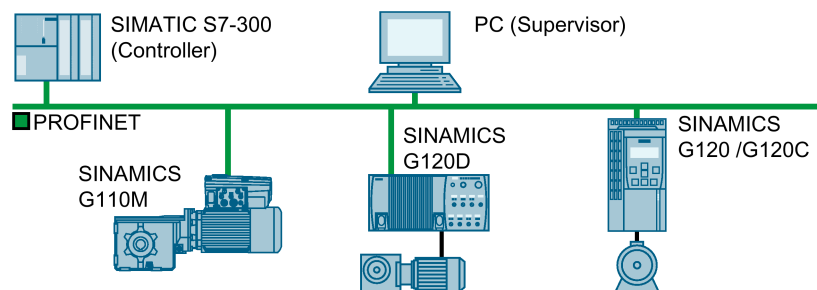

Figure 3-20 The inverter in PROFINET IO operation

The inverter supports the following functions:

- RT
- IRT: The inverter forwards the clock synchronism, but does not support clock synchronism.
- MRP: Media redundancy, impulsed with 200 ms. Requirement: Ring topology
- MRPD: Media redundancy, bumpless. Requirement: IRT and the ring topology created in the control
- Diagnostic alarms in accordance with the error classes specified in the PROFIdrive profile.
- Device replacement without removable data storage medium
- Shared Device for Control Units with fail-safe functions

The inverter as Ethernet node

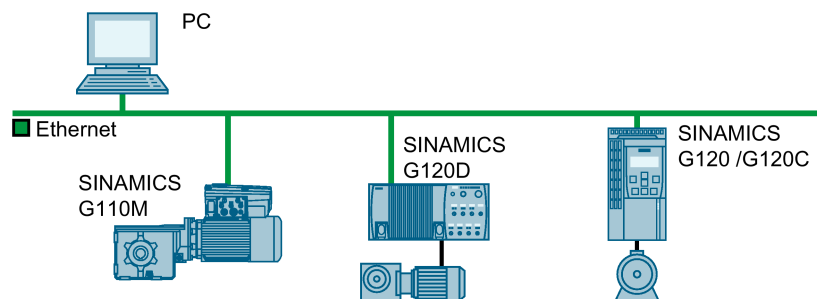



Figure 3-21 The inverter as Ethernet node

Further information on PROFINET

Further information on PROFINET can be found on the Internet:

-  PROFINET – the Ethernet standard for automation
(<http://w3.siemens.com/mcms/automation/en/industrial-communications/profinet/Pages/Default.aspx>)
-  PROFINET system description
(<https://support.industry.siemens.com/cs/ww/en/view/19292127>)

3.6.1 Converter with PROFINET interface

The pin assignment and the connectors that you require for your inverter are listed in the following tables.

You can implement either a ring or line-type topology using the two sockets at the inverter. You only require one of the two sockets at the beginning and end of a line.



You can use switches to realize other topologies.

Table 3- 13 Assignment table

Inverter/Control Unit		Connection via		
		X150 P1/ X150 P2 (RJ45)  8 ... 1	X03/X04 (RJ45)  1 ... 8	X03/X04 (M12) 
	G120			
	• CU230P-2 PN	x		
	• CU240E-2 PN	x		
	• CU240E-2 PN-F	x		
	• CU250S-2 PN	x		
	G120C			
	• G120C PN	x		
	G120D			
	• CU240D-2 PN			x
	• CU240D-2 PN-F			x
	• CU250D-2 PN-F			x
	• CU240D-2 PN-F [PP]		x	
	• CU250D-2 PN-F [PP]		x	
	G110M			
	• CU240M PN			x

3.6 Communication via PROFINET

Table 3- 14 Connector pin assignments

Signal	X150 P1/ X150 P2 (RJ45)  8 ... 1	X03/X04 (RJ45)  1 ... 8	X03/X04 (M12) 
TX-, transmit data -	1	1	1
RX+, receive data +	3	2	2
TX+ Transmit data +	2	3	3
RX-, receive data -	6	6	4
---	4	4	---
---	5	5	---
---	7	7	---
---	8	8	---

Recommended connector

RJ45, IP20: 6GK1901-1BB10-2Ax0

Information for assembling the SIMATIC NET Industrial Ethernet FastConnect RJ45 plug 180 can be found on the Internet:

Assembly instructions for the SIMATIC NET Industrial Ethernet FastConnect RJ45 plug (<http://support.automation.siemens.com/WW/view/en/37217116/133300>)



3.6.2 Integrating inverters into PROFINET

To connect the inverter to a control via PROFINET, proceed as follows:

Procedure

1. Integrate the inverter in the bus system (e.g. ring topology) of the control using PROFINET cables and the two PROFINET sockets X150-P1 and X150-P2 or X03 and X04.

The position of the sockets is available in the operating instructions for the inverter.

Pin assignment:  Converter with PROFINET interface (Page 61).

The maximum permitted cable length from the previous station and to the subsequent one is 100 m.

2. Externally supply the inverter with 24 V DC through terminals 31 and 32 or via X01.

The external 24 V supply is only required if communications with the control system should also operate when the line voltage is switched off.





You have now connected the inverter to the control system via PROFINET



3.6.3 PROFINET IO operation

3.6.3.1 What do you have to set for communication via PROFINET?

Check the communication settings using the following table. If you answer "Yes" to the questions, you have correctly set the communication settings and can control the inverter via the fieldbus.

Questions	Answer/description
Is the inverter correctly connected to the bus network?	 Integrating inverters into PROFINET (Page 62)
Do the IP address and device name in the inverter and control match?	 Configuring communication to the control (Page 63)
Is the same telegram set in the inverter the same as in the higher-level control?	Setting the telegram in the control
Are the signals that the inverter and the control exchange via PROFINET correctly interconnected?	Interconnect signals in the inverter in conformance with PROFIdrive.  PROFIDRIVE profile - Cyclic communication (Page 17)  PROFIDRIVE profile - Acyclic communication (Page 42)

Communication with the control, even when the line voltage is switched off

If, in your plant or system, communication with the control system should continue to function even when the line voltage is switched off, then you must externally supply the inverter/Control Unit with 24 V DC. To do this, use terminals 31 and 32 – or connector X01. You can find additional details in the operating instructions for the inverter or the Control Unit.

3.6.3.2 Configuring communication to the control

Configuring the communication using SIMATIC S7 control

If the inverter is not included in the hardware library, you have the following options:

- Install the most up to date Startdrive version
- Install the GSDML of the inverter using "Options/Manage general station description (GSD)" in the components catalog.

Configuring the communication using a non-Siemens control

1. Import the device file (GSDML) of the inverter into the engineering tool for your control system.
2. Configure the communication.

Configuring communication with Startdrive

Proceed as follows to make the settings for communication with the control system.

- Activate the following windows in Startdrive: "View/Project tree" and "View/Inspector window".
- Open the drive in the project tree and double click on "Device configuration".
This opens the dialog in the inspector window for setting the PROFINET interface.
- Click on "Ethernet addresses".
- Enter the appropriate values.

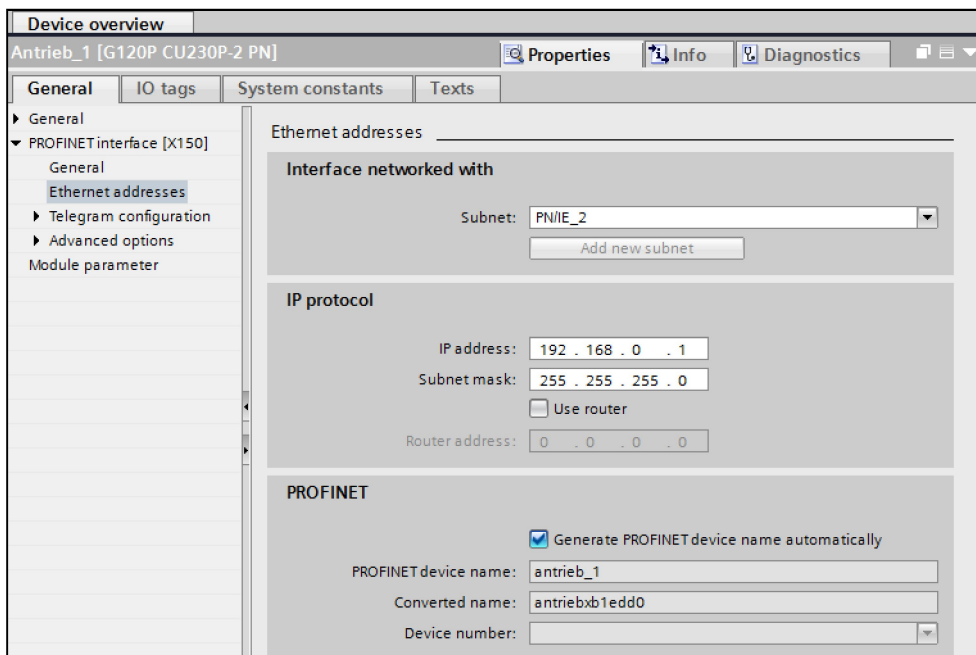

You have configured communication with the control system.



You can enter or read out data directly via the parameter view. To do this, select the "Communication" parameter group and the "Show advanced parameters" option.

3.6.3.3 Installing GSDML

Procedure

1. Save the GSDML to your PC.

- With Internet access:



GSDML (<https://support.industry.siemens.com/cs/ww/en/ps/13222/dl>)

- Without Internet access:

Insert a memory card into the inverter.

Set p0804 = 12.

The inverter writes the GSDML as zipped file (*.zip) into directory /SIEMENS/SINAMICS/DATA/CFG on the memory card.

2. Unzip the GSDML file on your computer.

3. Import the GSDML into the engineering system of the controller.

You have now installed the GSDML in the engineering system of the controller.



3.6.3.4 Activating diagnostics via the control

The converter provides the functionality to transmit fault and alarm messages (diagnostic messages) to the higher-level control according to the PROFIdrive error classes.

The functionality must be selected in the higher-level controller and activated by powering up.

3.6.4 PROFIenergy

PROFIenergy is an energy management standard for production plants, based on the PROFINET communication protocol. The functionality is certified and described in the PROFIenergy profile of the PNO.

The control transfers the PROFIenergy commands in acyclic operation to the inverter in data set 80A0 hex.

The inverters support the PROFIenergy profile V1.1 and the function unit class 3.

Parameters r5600 to p5614 are reserved for PROFIenergy functions in the inverter.



An application example for energy savings with PROFIenergy is available in the Internet at:

PROFIenergy - saving energy with SIMATIC S7
(<https://support.industry.siemens.com/cs/ww/en/view/41986454>)

3.6.4.1 General inverter behavior when in the PROFlenergy energy-saving mode

- When the PROFlenergy energy-saving mode is active, the inverter issues alarm A08800.
- If the PROFlenergy energy-saving mode is active, the RDY-LED flashes green as follows: 500 ms on, 3000 ms off.



- When the PROFlenergy energy-saving mode is active, the inverter does not send any diagnostic alarms.
- If the bus connection to the control system is interrupted while the inverter is in the energy-saving mode, the inverter exits the energy-saving mode and resumes normal operation.
- The inverter changes into normal operation if the control system goes into the stop condition while the inverter is in the energy-saving mode.

3.6.4.2 Supported PROFlenergy energy-saving modes

G110M, G120 and G120C inverters support the PROFlenergy energy-saving mode 2.

G120D inverters support the PROFlenergy energy-saving mode 1.

PROFlenergy energy-saving mode 2

Parameter r5600 shows the active PROFlenergy energy-saving mode.

Connector parameter r5613 indicates whether the PROFlenergy energy-saving mode is active. You can set additional responses using these parameters.

PROFlenergy energy-saving mode 1

PROFlenergy energy-saving mode 1 is an expansion of PROFlenergy energy-saving mode 2.

With PROFlenergy energy-saving mode 1, the inverter offers the following additional functions:

- The inverter switches off the power supply for its digital outputs if they are not interconnected with r5613.x (displays the energy-saving mode) or are being used as safety-relevant outputs.
- The inverter switches off the supply voltage of its encoders unless they are HTL encoders assigned to the position controller.

3.6.4.3 Settings and displays for PROFlenergy in the inverter

Pause time

- Minimum pause time: p5602
 - When the pause time, which is sent using command "Start_Pause", is equal to or greater than the value in p5602[1], then the inverter goes into the energy-saving mode.
 - When the pause time is less than p5602[1], the inverter rejects the command "Start_Pause" with 50 hex (no appropriate pause mode).
- Maximum pause time: p5606

Inhibiting PROFlenergy

If you set p5611.0 = 1, you block the response of the inverter to PROFlenergy control commands. In this case, the inverter rejects the "Start_Pause" command with 50 hex (no appropriate pause mode).

Transition into the energy-saving mode from the PROFIdrive states ready (S3) and operation (S4)

If you set p5611.2 = 1, you allow the transition into the energy-saving mode from the PROFIdrive states ready (S3) and operation (S4).

To do so, you must set one of the following settings:

- p5611.1 = 1: With the transition to the energy-saving mode, the inverter issues an OFF1 command and enters the start-inhibit state (S1).
- p5611.1 = 0: You can use p5614 to interconnect a signal source that switches the inverter off and places it in the start inhibited state (S1).

If the control sends the command "End_Pause" or "Start_Pause" with a pause time of 0, then the inverter does not restart, even if the appropriate enable signals are still set.

An OFF1/on command is required in order that the inverter restarts.

PROFlenergy measured values

PROFlenergy				Unit	SINAMICS source parameters		Range of values
Measured value		Accuracy			Number	Name	
ID	Name	Domain	Class				
34	Active power	1	12	W	r0032	Active power smoothed	r2004
166	Power factor	1	12	1	r0038	Smoothed power factor	0 ... 1
200	Active energy import	2	11	Wh	r0039[1]	Energy accepted	-

3.6.4.4 Control commands and status queries

PROFenergy control commands

- **Start_Pause**
Dependent on the pause duration, switches into the energy-saving mode.
 - For p5611.2 = 0, from operating states S1 (switching on inhibited) or S2 (ready to switch on)
 - For p5611.2 = 1, also from operating states S3 (ready) or S4 (operation).
- **Start_Pause_with_time_response**
Dependent on the pause duration switches into the energy-saving mode and also specifies the transition times in the command response.
 - For p5611.2 = 0, from operating states S1 (switching on inhibited) or S2 (ready to switch on)
 - For p5611.2 = 1, also from operating states S3 (ready) or S4 (operation).
- **End_Pause**
Switches from energy-saving mode to the operating state.
Cancels the switching from the operating state to the energy-saving mode.

PROFenergy status requests

- **List_Energy_Saving_Modes**
Determines all supported energy-saving modes.
- **Get_Mode**
Determines information about the selected energy-saving mode.
- **PEM_Status**
Determines the current PROFenergy status.
- **PEM_Status_with_CTTO**
Determines the current PROFenergy status, such as the PEM_Status, together with the regular transition time to the operating state.
- **PE_Identify**
Determines the supported PROFenergy commands.
- **Query_Version**
Shows the implemented PROFenergy profile.
- **Get_Measurement_List**
This command returns the measured value IDs that can be accessed using the "Get_Measurement_Values" command.
- **Get_Measurement_List_with_object_number**
This command returns the measured value IDs and the associated object number that can be accessed using the "Get_Measurement_Values_with_object_number" command.

- **Get_Measurement_Values**
The command returns the requested measured value using the measured value ID
- **Get_Measurement_Values_with_object_number**
The command returns the requested measured values using the measured value ID and the object number. The object number corresponds to the drive object ID.

Error values

Table 3- 15 Error values in the parameter response

Error value 1	Meaning
001 hex	Invalid Service_Request_ID
03 hex	Invalid Modifier
04 hex	Invalid Data_Structure_Identifier_RQ
06 hex	No PE energy-saving mode supported
07 hex	Response too long
08 hex	Invalid Block Header
50 hex	No suitable energy-saving mode available
51 hex	Time is not supported
52 hex	Impermissible PE_Mode_ID
53 hex	No switch to energy saving mode because of state operate
54 hex	service or function temporarily not available

3.6.5 The inverter with PROFINET interface as Ethernet node.

As default setting, the inverter is set for PROFINET IO communication. Alternatively, you have the option of integrating the inverter into an Ethernet network via the PROFINET interface.

This means that from any location in a network, you can use Startdrive to make diagnostic queries, change parameters or carry out commissioning work.

PROFINET I/O communication is not possible with the inverter as Ethernet node.

Integrating an inverter into an Ethernet network (assigning an IP address)

Procedure

1. Set p8924 (PN DHCP mode) = 2 oder 3
 - p8924 = 2: The DHCP server assigns the IP address based on the MAC address of the inverter.
 - p8924 = 3: The DHCP server assigns the IP address based on the device name of the inverter.
2. Save the settings with p8925 = 2. The next time that the inverter switches on, it retrieves the IP address, and you can address the inverter as Ethernet node.

Note

Immediate switchover without restart

The switchover to DHCP is performed immediately and without a restart if the change is carried out with the Ethernet/IP command "Set Attribute Single" (class F5 hex, attribute 3). The following options are available:

- via an Ethernet/IP controller
 - via an Ethernet/IP commissioning tool
-

You have now integrated the inverter into Ethernet.



Displays

r8930: Device name of the inverter

r8934: Operating mode, PN or DHCP

r8935: MAC address

Additional information

You can find information about parameters and messages (A08565) in the List Manual of the inverter.



Overview of the manuals (Page 232).

Additional options of integrating inverters into Ethernet

You also have the option of integrating the inverter into Ethernet using Proneta or STEP7, for example.

Here is the example of the "Edit Ethernet station" screen form from Step 7, which you can use to make the required settings.

The screenshot shows the "Ethernet-Teilnehmer bearbeiten" dialog box. It contains the following sections and controls:

- Ethernet Teilnehmer:** A section with a "MAC-Adresse:" label, an empty text input field, and a "Durchsuchen..." button. The text "Online erreichbare Teilnehmer" is displayed to the right.
- IP-Konfiguration einstellen:** A section with two radio buttons:
 - IP-Parameter verwenden: Includes "IP-Adresse:" and "Subnetzmaske:" labels, each followed by an empty text input field. To the right, under "Netzübergang", are two radio buttons: Keinen Router verwenden and Router verwenden. Below the second radio button is an "Adresse:" label and an empty text input field.
 - IP-Adresse von einem DHCP-Server beziehen: Includes a sub-section "identifiziert über" with three radio buttons: Client-ID, MAC-Adresse, and Geräte-name. Below these is a "Client-ID:" label and an empty text input field.
- Gerätename vergeben:** A section with a "Gerätename:" label, an empty text input field, and a "Name zuweisen" button.
- Rücksetzen auf Werkseinstellungen:** A section with a "Zurücksetzen" button.
- Buttons:** "IP-Konfiguration zuweisen" button below the DHCP section, "Schließen" button at the bottom left, and "Hilfe" button at the bottom right.

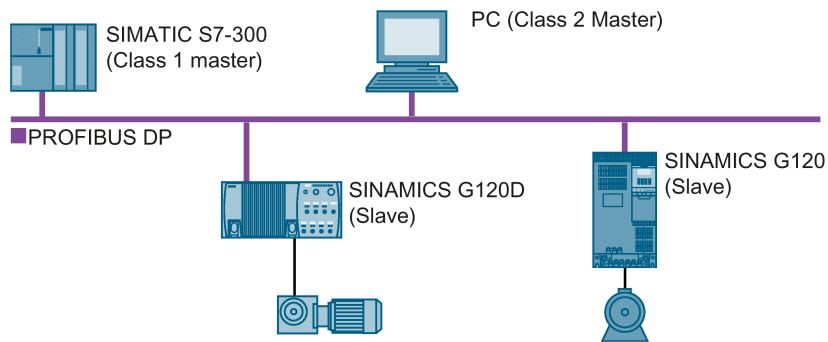

3.7 Communication via PROFIBUS



The PROFIBUS DP interface has the following functions:

- Cyclic communication
- Acyclic communication
- Diagnostic alarms

General information on PROFIBUS DP can be found in the Internet:

-  PROFIBUS information (<https://support.industry.siemens.com/cs/ww/en/view/1971286>)
-  Installation guidelines of the PNO (<http://www.profibus.com/downloads/installation-guide/>)

3.7.1 Inverters with PROFIBUS interface

You can find the connectors and the connector assignments of the PROFIBUS DP interface in the following tables.

You can implement a line-type topology using the two connectors at the inverter. You can use switches to realize other topologies.

Table 3- 16 Assignment table - connectors







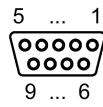

Inverter/Control Unit		Connection via		
		X126 (D Sub - socket) 	X03, on (M12) 	X04, off (M12) 
	G120			
	• CU230P-2 DP	x		
	• CU240B-2 DP	x		
	• CU240E-2 DP	x		
	• CU240E-2 DP-F	x		
• CU250S-2 DP	x			
	G120C			
	• G120C DP	x		
	G120D			
	• CU240D-2 DP		x	x
	• CU240D-2 DP-F		x	x
• CU250D-2 DP-F		x	x	
	G110M			
	• CU240M DP		x	x

Table 3- 17 Connector pin assignments

Signal	X126 (D Sub - socket) 	X03, on (M12) 	X04, off (M12) 
Shield, ground connection	1	5	5
---	2	1	1
RxD/TxD-P, receive and transmit (B/B')	3	4	4
CNTR-P, control signal	4	---	---
DGND, reference potential for data (C/C')	5	---	---
VP, supply voltage	6	---	---
---	7	3	3
RxD/TxD-N, receive and transmit (A/A')	8	2	2
---	9	---	---

Recommended PROFIBUS connectors

We recommend connectors with the following article numbers for connecting the PROFIBUS cable:

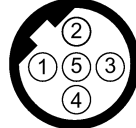
- 6GK1500-0FC10
- 6GK1500-0EA02

3.7.2 What do you have to set for communication via PROFIBUS?

Configuring PROFIBUS communication

You require the appropriate engineering system to configure PROFIBUS communication in the PROFIBUS master.

If required, load the GSD file of the inverter into the engineering system.



Configuring communication to the control system (Page 76)

Setting the address

Set the address of the PROFIBUS slave.



Setting the address (Page 78)

Setting the telegram

Set the telegram in the inverter as in the PROFIBUS master. Interconnect the telegrams in the control program of the PROFIBUS master with the signals of your choosing.



PROFIDRIVE profile - Cyclic communication (Page 17)

Application examples

You can find application examples for PROFIBUS communication on the Internet:



Controlling the speed of a SINAMICS G110M/G120/G120C/G120D with S7-300/400F via PROFINET or PROFIBUS, with Safety Integrated (via terminal) and HMI

(<https://support.industry.siemens.com/cs/ww/en/view/60441457>)



Controlling the speed of a SINAMICS G110M / G120 (Startdrive) with S7-1500 (TO) via PROFINET or PROFIBUS, with Safety Integrated (via terminal) and HMI

(<https://support.industry.siemens.com/cs/ww/en/view/78788716>)

3.7.3 Integrating inverters into PROFIBUS

To connect the inverter to a control system via PROFIBUS DP, proceed as follows:

Procedure

1. Integrate the inverter into the bus system (e.g. line-type topology) using PROFIBUS cables.
 - Inverters with IP20 degree of protection: via socket X126
 - Inverters with degree of protection IP65 (CU240D/CU250D) via X03 and X04

The position of the socket is explained in the operating instructions for the inverter.

Pin assignment:  Inverters with PROFIBUS interface (Page 73).

The maximum permitted cable length to the previous station and the subsequent one is 100 m at a baud rate of 12 Mbit/s. You can achieve a maximum cable length of 400 m by using a maximum of 3 repeaters.

2. Externally supply the inverter with 24 V DC through terminals 31 and 32 or via X01.

The external 24 V supply is only required if communications with the control system should also operate when the line voltage is switched off.

You have now connected the inverter to the control system using PROFIBUS DP.



3.7.4 Configuring communication to the control system

Configure the communication in the control system after you have connected the inverter to the bus.

3.7.4.1 Configuring the communication using SIMATIC S7 control

- If the inverter is listed in the component catalog in the TIA Portal, you can configure the communication in the SIMATIC control.
- If the inverter is not listed in the hardware library, you can either install the newest Startdrive version or install the GSD of the inverter via "Extras/GSD-Install file" in HW-Config.

3.7.4.2 Configuring the communication with a third-party control system

If you are working with a third-party control system, you must install the device file (GSD) of the inverter in the control before you configure the communication.

 Installing the GSD (Page 77) .

If you have installed the GSD, configure the communication. To do this, follow the documentation of your control system.

3.7.4.3 Installing the GSD

Procedure

1. Save the GSD on your PC via one of the following methods.

- With Internet access:



GSD (<http://support.automation.siemens.com/WW/view/en/22339653/133100>)

- Without Internet access:

Insert a memory card into the inverter.

Set p0804 to 12.

The inverter writes the GSD as zipped file (*.zip) into directory /SIEMENS/SINAMICS/DATA/CFG on the memory card.

2. Unzip the GSD file on your computer.

3. Import the GSD in the engineering system of the controller.

You have now installed the GSD file in the engineering system of the controller.



3.7.5 Setting the address

Valid address area: 1 ... 125

You have the following options for setting the address:

- Using the address switch on the Control Unit:

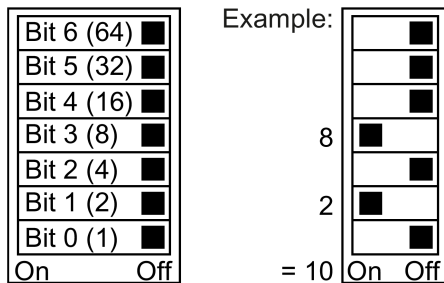

Figure 3-22 Address switch with example for bus address 10

The address switch has priority over the other settings.

- Using Startdrive or an operator panel via parameter p0918 (default setting: p0918 = 126) It is only possible to change p0918 if an invalid address is set in the address switch.

If you are working with Startdrive, back up the settings so they are not lost if the power fails.

You can find the position of the address switch in the operating instructions for the inverter.

 Manuals and technical support (Page 232)

Activating the changed bus address

Procedure

1. Set the address as described above.
2. Switch off the inverter power supply.
3. Wait until all LEDs on the inverter are dark.
4. Switch on the inverter power supply again.

Your settings become effective after switching on.

You have now set the bus address.

□

3.8 Select telegram

Precondition

In the basic commissioning you have selected the control using PROFIBUS or PROFINET.

Telegrams for SINAMICS G120 inverters

The following table shows all of the telegrams for the G120 inverter.

In your inverter you have a list of telegrams that are available for your particular inverter.

Value p0922

- 1: Standard telegram 1, PZD-2/2 (factory setting, exceptions: CU250D and CU250S)
- 2: Standard telegram 2, PZD-4/4
- 3: Standard telegram 3, PZD-5/9
- 4: Standard telegram 4, PZD-6/14
- 7: Standard telegram 7, PZD 2/2 (factory setting CU250D)
- 9: Standard telegram 9, PZD-10/5
- 20: Standard telegram 20, PZD-2/6
- 110: SIEMENS telegram 110, PZD-12/7
- 112: SIEMENS telegram 111, PZD-12/12
- 350: SIEMENS telegram 350, PZD-4/4
- 352: SIEMENS telegram 352, PZD-6/6
- 353: SIEMENS telegram 353, PZD-2/2, PKW-4/4
- 354: SIEMENS telegram 354, PZD-6/6, PKW-4/4
- 999: Free telegram  Extend telegram/change signal interconnection (Page 33)
(factory setting, CU250S)

For further information about telegrams:

 PROFIDRIVE profile - Cyclic communication (Page 17).

PROFIsafe telegram selection

The settings for the PROFIsafe telegram selection are described in the "Safety Integrated" Function Manual.

Communication via EtherNet/IP

EtherNet/IP is real-time Ethernet, and is mainly used in automation technology.

You have the following options of integrating SINAMICS G120 inverters into EtherNet/IP:

- You use the SINAMICS profile
- You use the ODVA AC/DC drive profile
- You define the assemblies for the process data using the objects that are supported by the inverter



Configuring communication via EtherNet/IP (Page 86).

The pin assignment and the connectors that you require for your inverter are listed in the following tables.

You can implement a line-type topology using the two sockets at the inverter. You only require one of the two sockets at the beginning and end of a line.



You can use switches to realize other topologies.

4.1 Inverters with Ethernet/IP interface

Table 4- 1 Assignment table

Inverter/Control Unit		Connection via		
		X150 P1/ X150 P2 (RJ45)  8 ... 1	X03/X04 (RJ45)  1 ... 8	X03/X04 (M12) 
	G120			
	• CU230P-2 PN	x		
	• CU240E-2 PN	x		
	• CU240E-2 PN-F	x		
	• CU250S-2 PN	x		
	G120C			
	• G120C PN	x		
	G120D			
	• CU240D-2 PN			x
	• CU240D-2 PN-F			x
	• CU250D-2 PN-F			x
	• CU240D-2 PN-F [PP]		x	
	• CU250D-2 PN-F [PP]		x	
	G110M			
	• CU240M PN			x

Table 4- 2 Connector pin assignments

Signal	X150 P1/ X150 P2 (RJ45)  8 ... 1	X03/X04 (RJ45)  1 ... 8	X03/X04 (M12) 
TX-, transmit data -	1	1	1
RX+, receive data +	3	2	2
TX+ Transmit data +	2	3	3
RX-, receive data -	6	6	4
---	4	4	---
---	5	5	---
---	7	7	---
---	8	8	---

Recommended connector

RJ45, IP20: 6GK1901-1BB10-2Ax0



Information for assembling the SIMATIC NET Industrial Ethernet FastConnect RF45 plug 180 can be found on the Internet:

Assembly instructions for the SIMATIC NET Industrial Ethernet FastConnect RJ45 plug (<https://support.industry.siemens.com/cs/ww/en/ps/15251/man>)

4.2 Connect converter to Ethernet/IP

To connect the inverter to a control system via Ethernet, proceed as follows:

Procedure

1. Connect the inverter to the control system via an Ethernet cable.
2. You create an object for data exchange.

You have the following options:

- Load the EDS file into your controller if you want to use the ODVA profile.

You can find the EDS file in the Internet:



EDS (<https://support.industry.siemens.com/cs/ww/de/view/78026217>)

- If your controller does not accept the EDS file, or if you wish to use the SINAMICS profile, you must create a generic module in your controller:



Create generic I/O module (Page 103)

You have connected the inverter to the control system via EtherNet/IP.



In addition, you can find a detailed description of how to connect a SINAMICS G converter to a controller via Ethernet/IP at the following link:



Application example (<https://support.industry.siemens.com/cs/ww/en/view/82843076>)

Routing and shielding Ethernet cables

Information can be found on the Internet:



EtherNet/IP

(<http://www.odva.org/Home/ODVATECHNOLOGIES/EtherNetIP/EtherNetIPLibrary/tabid/76/ing/en-US/Default.aspx>)

Commissioning the inverter in an EtherNet/IP network

To commission the inverter, connect the inverter via the USB interface with your computer on which Startdrive has been installed.

For additional information, refer to the operating instructions of your inverter.



Manuals and technical support (Page 232)

4.3 What do you need for communication via Ethernet/IP?

Check the communication settings using the following questions. If you answer "Yes" to the questions, you have correctly set the communication settings and can control the inverter via the fieldbus.

- Is the inverter correctly connected to the EtherNet/IP?
- Is the EDS file installed in your control system?
- Have the bus interface and IP address been correctly set?
- Have the signals that the inverter and the control system exchange been correctly interconnected?

4.4 Configuring communication via EtherNet/IP

Make the following settings in order to communicate with a higher-level control via EtherNet/IP:

Procedure

1. p2030: set a value of 10: Fieldbus interface protocol selection Ethernet/IP:
2. p8921: Enter the IP address. You can find the currently valid address in r8931.
3. p8923: Enter the subnet mask. You can find the currently valid subnet mask in r8933.
4. p8922: Enter the standard gateway. You can find the currently valid Default Gateway in r8932.
5. p8920: Enter the station name.
6. p8925: Set a value of 2: Save and activate PN interface configuration
7. Switch off the inverter power supply.
8. Wait until all LEDs on the inverter are dark.
9. Switch on the inverter power supply again.

Your settings become effective after switching on.

You have now configured the inverter for communication via EtherNet/IP.



Parameters p8921 ... p8925 apply if p2030 = 10 is set, for EtherNet/IP, even if the parameter names indicates PROFINET.

4.4.1 Communication settings

You set the communication using parameter p8980. You have the following options

Communication via the SINAMICS profile

The SINAMICS profile is a drive profile for EtherNet/IP defined by Siemens, based on PROFIdrive, and is factory set in the inverters.

Setting: p8980 = 0

With the SINAMICS profile, you can use each of the telegrams listed in parameter p0922

Communication via the ODVA AC/DC drive profile

The ODVA AC/DC drive profile is a drive profile defined by the ODVA organization

Setting: p8980 = 1

With the AC/DC profile of ODVA, you select the standard telegram, p0922 = 1

Communication settings via EtherNet/IP objects and assemblies

If you are using assemblies, which are described in the "Supported objects" ( Supported objects (Page 88)), then you must integrate the inverter yourself into the control system. Details on this topic can be found in the documentation of your control system.

4.4.2 Special issues if you wish to use the ODVA AC/DC Drive profile

If you change the following parameters using Startdrive or an operator panel, you must switch off the inverter power supply and switch it on again in order for the changes to become effective.

Setting the off response for the motor

You set the standard off response for the inverter using parameter p8981:

- p8981 = 0: OFF1 (factory setting), also corresponds to the setting in the SINAMICS profile
- p8981 = 1: OFF2

You can find details about OFF1 and OFF2 in the operating instructions of the Control Unit in the Section "Switching on and switching off a motor".

Setting the speed and torque scaling

You scale the speed and torque display using parameter p8982 or p8983. Setting range: 2^5 to 2^{-5} .

Displaying the maximum process data that can be transferred (PZD)

- r2067[0] maximum interconnected PZD length - receiving
- r2067[1] maximum interconnected PZD length - sending

Switching over the master control from the controller to Startdrive

In order to retrieve the master control using Startdrive, you must either switch the CPU to STOP, or interrupt the connection to the controller.

4.5 Supported objects

Overview

Object class		Object name	Objects re-quired	ODVA objects	SINAMICS objects
hex	dec				
1 hex	1	Identity object	x		
4 hex	4	Assembly Object	x		
6 hex	6	Connection Management Object	x		
28 hex	40	Motor Data Object		x	
29 hex	41	Supervisor Object		x	
2A hex	42	Drive Object		x	
32C hex	812	Siemens Drive Object			x
32D hex	813	Siemens Motor Data Object			x
F5 hex	245	TCP/IP Interface Object ¹⁾	x		
F6 hex	246	Ethernet Link Object ¹⁾	x		
300 hex	768	Stack Diagnostic Object		x	x
302 hex	770	Adapter Diagnostic Object		x	x
303 hex	771	Explicit Messages Diagnostic Object		x	x
304 hex	772	Explicit Message Diagnostic List Object		x	x
401 hex	1025	Parameter object		x	x

¹⁾ These objects are part of the EtherNet/IP system management.

Identity Object, Instance Number: 1 hex

Supported services

- | | |
|--|--|
| <p>Class</p> <ul style="list-style-type: none"> • Get Attribute all • Get Attribute single | <p>Instance</p> <ul style="list-style-type: none"> • Get Attribute all • Get Attribute single • Reset |
|--|--|

Table 4- 3 Class Attribute

No.	Service	Type	Name
1	get	UINT16	Revision
2	get	UINT16	Max Instance
3	get	UINT16	Num of Instances

Table 4- 4 Instance Attribute

No.	Service	Type	Name	Value/explanation
1	get	UINT16	Vendor ID	1251
2	get	UINT16	Device Type - ODVA AC Drive - Siemens Drive	02 hex 12 hex
3	get	UINT16	Product code	r0964[1]
4	get	UINT16	Revision	The versions should match the EDS file
5	get	UINT16	Status	See the following table
6	get	UINT32	Serial number	bits 0 ... 19: consecutive number; bits 20 ... 23: Production identifier bits 24 ... 27: Month of manufacture (0 = Jan, B = Dec) Bits 28 ... 31: Year of manufacture (0 = 2002)
7	get	Short String	Product name	max. length 32 bytes e.g. SINAMICS G120

Table 4- 5 Explanation of No. 5 of the previous table

Byte	Bit	Name	Description
1	0	Owned	0: Inverter is not assigned to any master 1: Inverter is assigned to a master
	1		Reserved
	2	Configured	0: Ethernet/IP basic settings 1: Modified Ethernet/IP settings For G120, always = 1
	3		Reserved
	4 ... 7	Extended Device Status	0: Self-test or status not known 1: Firmware update active 2: At least one I/O connection with error 3: No I/O connections 4: Incorrect configuration in the ROM 5: Fatal fault 6: At least one I/O connection is active 7: All I/O connections in the quiescent state 8 ... 15: Reserved
2	8 ... 11		Not used
	12 ... 15		Reserved

4.5 Supported objects

Assembly Object, Instance Number: 4 hex

Supported services

- | | | | |
|-------|--|----------|--|
| Class | <ul style="list-style-type: none"> • Get Attribute single | Instance | <ul style="list-style-type: none"> • Get Attribute single • Set Attribute single |
|-------|--|----------|--|

Table 4- 6 Class Attribute

No.	Service	Type	Name
1	get	UINT16	Revision
2	get	UINT16	Max Instance
3	get	UINT16	Num of Instances

Table 4- 7 Instance Attribute

No.	Service	Type	Name	Value/explanation
3	get	Array of UINT8	Assembly	1 byte array  Supported ODVA AC/DC assemblies (Page 102)

Connection Management Object, Instance Number: 6 hex

Supported services

- | | |
|---|--|
| <p>Class</p> <ul style="list-style-type: none"> • Get Attribute all • Get Attribute single | <p>Instance</p> <ul style="list-style-type: none"> • Forward open • Forward close • Get Attribute single • Set Attribute single |
|---|--|

Table 4- 8 Class Attribute

No.	Service	Type	Name
1	get	UINT16	Revision
2	get	UINT16	Max Instance
3	get	UINT16	Num of Instances

Table 4- 9 Instance Attribute

No.	Service	Type	Name	Value/explanation
1	get	UINT16	OpenReqs	Counters
2	get	UINT16	OpenFormat Rejects	Counters
3	get	UINT16	OpenResource Rejects	Counters
4	get	UINT16	OpenOther Re-jects	Counters
5	get	UINT16	CloseReqs	Counters
6	get	UINT16	CloseFormat Rejects	Counters
7	get	UINT16	CloseOther Re-jects	Counters
8	get	UINT16	ConnTimeouts	Counters Number of bus errors

4.5 Supported objects

Motor Data Object, Instance Number 28 hex

Supported services

- | | | | |
|-------|------------------------|----------|------------------------|
| Class | • Get Attribute single | Instance | • Get Attribute single |
| | | | • Set Attribute single |

Table 4- 10 Class Attribute

No.	Service	Type	Name
1	get	UINT16	Revision
2	get	UINT16	Max Instance
3	get	UINT16	Num of Instances

Table 4- 11 Instance Attribute

No.	Service	Type	Name	Value/explanation
3	get, set	USINT	Motor Type	p0300 motor type, see the following table
6	get, set	UINT16	Rated Current	p0305 rated motor current
7	get, set	UINT16	Rated Voltage	p0304 rated motor voltage
8	get, set	UINT32	Rated Power	p0307 rated motor power
9	get, set	UINT16	Rated Frequency	p0310 rated motor frequency
10	get, set	UINT16	Rated Temperature	p0605 motor temperature threshold
11	get, set	UINT16	Max Speed	p0322 maximum motor speed
12	get, set	UINT16	Pole Count	p0314 value of p0314*2
13	get, set	UINT32	Torque Constant	p0316 motor torque constant
14	get, set	UINT32	Inertia	p0341 motor moment of inertia
15	get, set	UINT16	Base Speed	p0311 motor rated speed

Value in p0300		Ethernet/IP motor data object,	
0	No motor	0	Non-standard motor
1	induction motor	7	squirrel cage induction motor
2	synchronous motor	3	PM synchronous motor
10	1LE1 induction motor	7	squirrel cage induction motor
13	1LG6 induction motor	7	squirrel cage induction motor
17	1LA7 induction motor	7	squirrel cage induction motor
19	1LA9 induction motor	7	squirrel cage induction motor
100	1LE1 induction motor	7	squirrel cage induction motor
104	1PH4 induction motor	3	PM synchronous motor
107	1PH7 induction motor	0	non-standard motor
108	1PH8 induction motor	5	switched reluctance motor
200	1PH8 synchronous motor	0	non-standard motor
204	1LE4 synchronous motor	3	PM synchronous motor
237	1FK7 synchronous motor	0	non-standard motor
10000	motor with DRIVE-CLiQ	0	non-standard motor
10001	motor with DRIVE-CLiQ 2. D	0	non-standard motor

Supervisor Object, Instance Number: 29 hex

Supported services

- | | | | |
|-------|------------------------|----------|------------------------|
| Class | • Get Attribute single | Instance | • Get Attribute single |
| | | | • Set Attribute single |

Table 4- 12 Class Attribute

No	Service	Type	Name
1	get	UINT16	Revision
2	get	UINT16	Max Instance
3	get	UINT16	Num of Instances

Table 4- 13 Instance Attribute

No	Service	Type	Name	Value/explanation
3	get, set	Bool	Run1	STW.0 operation, clockwise rotation
5	get, set	Bool	Net Control	Internal 0: Local 1: Network
6	get	UINT8	State	0: Vendor Specific 1: Startup 2: Not_Ready 3: Ready 4: Enabled 5: Stopping 6: Fault_Stop 7: Faulted
7	get	Bool	Running1	ZSW1:2 1: - (Enabled and Run1) or - (Stopping and Running1) or - (Fault_Stop and Running1) 0 = Other state
9	get	Bool	Ready	ZSW1:0 1: - Ready or - Enabled or - Stopping 0 = Other state
10	get	Bool	Fault	ZSW1:3 drive fault
11	get	Bool	Warning	ZSW1:7 alarm active
12	get, set	Bool	Fault reset	STW.7 acknowledge fault
13	get	UINT16	Fault Code	r945[0] error code
14	get	UINT16	Warning Code	r2122[0] alarm code
15	get	Bool	CtlFromNet	Display from Net Control 1: Control from network 0: Local control

4.5 Supported objects

Drive Object, Instance Number: 2A hex

Supported services

- | | | | |
|-------|------------------------|----------|------------------------|
| Class | • Get Attribute single | Instance | • Get Attribute single |
| | | | • Set Attribute single |

Table 4- 14 Class Attribute

No	Service	Type	Name
1	get	UINT16	Revision
2	get	UINT16	Max Instance
3	get	UINT16	Num of Instances

Table 4- 15 Instance Attribute

No	Service	Type	Name	Value/explanation
3	get	Bool	At reference	r2197.4 1: n_act ≥ n_set 0: Otherwise
4	get, set	Bool	Net_reference	Internal 0: Local 1: Network
6	get	UINT8	Drive_Mode	p1300 manufacturer-specific, see following table
7	get	INT	Speed Actual	Main actual value, see speed units
8	get, set	INT	Speed Ref	Main setpoint, see speed units
9	get	INT	Current Actual	r0027 absolute current actual value, smoothed
10	get, set	INT	Current limit	p0323 maximum motor current
15	get	INT	Power Actual	r0032 actual active power smoothed
16	get	INT	Input voltage	r0025 output voltage smoothed
17	get	INT	Output voltage	r0072 output voltage
18	get, set	UINT16	AccelTime	p1120 ramp-function generator ramp-up time
19	get, set	UINT16	DecelTime	p1121 ramp-function generator, ramp-down time
20	get, set	UINT16	Low Speed Lim	p1080 minimum speed
21	get, set	UINT16	High Speed Lim	p1082 maximum speed
22	get, set	SINT	Speed Scale	p8982 Ethernet/IP ODVA speed scaling
29	get	Bool	Ref From Net	Internal - display of Net_Reference 0: Local 1: Network

Value in p1300		Ethernet/IP motor data object	
0	U/f with linear characteristics	1	Open loop speed (Frequency)
1	U/f with linear characteristics and FCC	0	Vendor specific mode
2	U/f with parabolic characteristics	0	Vendor specific mode
3	U/f with parameterizable characteristics	0	Vendor specific mode
4	U/f with linear characteristics and ECO	0	Vendor specific mode
5	U/f for precise frequency drive (textile sector)	0	Vendor specific mode
6	U/f for precise frequency drive and FCC	0	Vendor specific mode
7	U/f for parabolic characteristics and ECO	0	Vendor specific mode
19	U/f with independent voltage setpoint	0	Vendor specific mode
20	Closed-loop speed control (without encoder)	2	Closed loop speed control
22	Closed-torque control (without encoder)	3	Torque control

Siemens Drive Object, Instance Number: 32C hex

Supported services

- | | | | |
|-------|------------------------|----------|--|
| Class | • Get Attribute single | Instance | • Get Attribute single
• Set Attribute single |
|-------|------------------------|----------|--|

Table 4- 16 Class Attribute

No.	Service	Type	Name
1	get	UINT16	Revision
2	get	UINT16	Max Instance
3	get	UINT16	Num of Instances

Table 4- 17 Instance Attribute

No.	Service	Name	Value/explanation
2	get, set	Commissioning state	p0010 commissioning parameter filter
3 ... 18	get	STW1	STW1 bit-by-bit access: Attr.3 = STW1.0 Attr.18 = STW1.15
19	get	Main setpoint	Main setpoint
20 ... 35	get	ZSW1	ZSW1 bit-by-bit access: Attr.20 = ZSW1.0 Attr.35 = ZSW1.15
36	get	Actual Frequency	Main actual value (actual frequency)
37	get, set	Ramp Up Time	p1120[0] ramp-function generator ramp-up time
38	get, set	Ramp Down Time	p1121[0] ramp-function generator ramp-down time
39	get, set	Current Limit	p0640[0] current limit
40	get, set	Frequency MAX Limit	p1082[0] maximum speed
41	get, set	Frequency MIN Limit	p1080[0] minimum speed
42	get, set	OFF3 Ramp Down Time	p1135[0] OFF3 ramp-down time
43	get, set	PID Enable	p2200[0] technology controller enable

4.5 Supported objects

No.	Service	Name	Value/explanation
44	get, set	PID Filter Time Constant	p2265 technology controller actual value filter time constant
45	get, set	PID D Gain	p2274 technology controller differentiation time constant
46	get, set	PID P Gain	p2280 technology controller proportional gain
47	get, set	PID I Gain	p2285 technology controller integral time
48	get, set	PID Up Limit	p2291 technology controller maximum limiting
49	get, set	PID Down Limit	p2292 technology controller minimum limiting
50	get	Speed setpoint	r0020 speed setpoint
51	get	Output Frequency	r0024 output frequency
52	get	Output Voltage	r0025 output voltage
53	get	DC Link Voltage	r0026[0] DC link voltage
54	get	Actual Current	r0027 current actual value
55	get	Actual Torque	r0031 torque actual value
56	get	Output power	r0032 actual active power value
57	get	Motor Temperature	r0035[0] motor temperature
58	get	Power Unit Temperature	r0037[0] power unit temperature
59	get	Energy kWh	r0039 energy display
60	get	CDS Eff (Local Mode)	r0050 active command data set
61	get	Status Word 2	r0053 status word 2
62	get	Control Word 1	r0054 control word 1
63	get	Motor Speed (Encoder)	r0061 speed actual value
64	get	Digital Inputs	r0722 digital inputs status
65	get	Digital Outputs	r0747 digital outputs status
66	get	Analog Input 1	r0752[0] analog input 1
67	get	Analog Input 2	r0752[1] analog input 2
68	get	Analog Output 1	r0774[0] analog output 1
69	get	Analog Output 2	r0774[1] analog output 2
70	get	Fault Code 1	r0947[0] fault number 1
71	get	Fault Code 2	r0947[1] fault number 2
72	get	Fault Code 3	r0947[2] fault number 3
73	get	Fault Code 4	r0947[3] fault number 4
74	get	Fault Code 5	r0947[4] fault number 5
75	get	Fault Code 6	r0947[5] fault number 6
76	get	Fault Code 7	r0947[6] fault number 7
77	get	Fault Code 8	r0947[7] fault number 8
78	get	Pulse Frequency	r1801 pulse frequency
79	get	Alarm Code 1	r2110[0] alarm number 1
80	get	Alarm Code 2	r2110[1] alarm number 2

No.	Service	Name	Value/explanation
81	get	Alarm Code 3	r2110[2] alarm number 3
82	get	Alarm Code 4	r2110[3] alarm number 4
83	get	PID setpoint Output	r2260 technology controller setpoint after the ramp-function generator
84	get	PID Feedback	r2266 technology controller actual value after the filter
85	get	PID Output	r2294 technology controller output signal

Siemens Motor Data Object, Instance Number: 32D hex

Supported services

- Class
- Get Attribute single
- Instance
- Get Attribute single
 - Set Attribute single

Table 4- 18 Class Attribute

No.	Service	Type	Name
1	get	UINT16	Revision
2	get	UINT16	Max Instance
3	get	UINT16	Num of Instances

Table 4- 19 Instance Attribute

No.	Service	Type	Name	Value/explanation
2	get, set	UINT16	Commissioning state	p0010
3	get	INT16	Motor Type	p0300
6	get, set	REAL	Rated Current	p0305
7	get, set	REAL	Rated Voltage	p0304
8	get, set	REAL	Rated Power	p0307
9	get, set	REAL	Rated Frequency	p0310
10	get, set	REAL	Rated Temperature	p0605
11	get, set	REAL	Max Speed	p0322
12	get, set	UINT16	Pole pair number	p0314
13	get, set	REAL	Torque Constant	p0316
14	get, set	REAL	Inertia	p0341
15	get, set	REAL	Base Speed	p0311
19	get, set	REAL	Cos Phi	p0308

4.5 Supported objects

TCP/IP Interface Object, Instance Number: F5 hex

Supported services

- | | | | |
|-------|---|----------|---|
| Class | <ul style="list-style-type: none"> • Get Attribute all • Get Attribute single | Instance | <ul style="list-style-type: none"> • Get Attribute all • Get Attribute single • Set Attribute single |
|-------|---|----------|---|

Table 4- 20 Class Attribute

No.	Service	Type	Name
1	get	UINT16	Revision
2	get	UINT16	Max Instance
3	get	UINT16	Num of Instances

Table 4- 21 Instance Attribute

No.	Service	Type	Name	Value/explanation
1	get	UNIT32	Status	Fixed value: 1 hex 1: Configuration acknowledged, by DHCP or saved values
2	get	UNIT32	Configuration Capability	Fixed value: 94 hex 4 hex: DHCP supported, 10 hex: Configuration can be adjusted, 80 hex: ACD-capable
3	get, set	UNIT32	Configuration Control	1 hex: Saved values 3 hex: DHCP
4	get	UNIT16	Path Size (in WORDs)	Fixed value: 2 hex
		UNIT8	Path	20 hex, F6 hex, 24 hex, 05 hex, where 5 hex is the number of instances of F6 hex (four physical ports plus one internal port).
5	get, set	STRING	Interface Configuration	r61000 Name of Station
		UNIT32		r61001 IP address
6	get, set	UNIT16	Host Name	Host Name Length
		STRING		
10	get, set	UNIT8	Select ACD	local OM flash: 0: Disabled, 1: Enabled
11	get, set	UNIT8	Last Conflict Detected	local OM flash ACD Activity
		UNIT8		local OM flash Remote MAC
		UNIT8		local OM flash ARP PDU

Link Object, Instance Number: F6 hex

Supported services

- | | | | |
|-------|---|----------|---|
| Class | <ul style="list-style-type: none"> • Get Attribute all • Get Attribute single | Instance | <ul style="list-style-type: none"> • Get Attribute all • Get Attribute single • Set Attribute single |
|-------|---|----------|---|

Table 4- 22 Class Attribute

No.	Service	Type	Name
1	get	UINT16	Revision
2	get	UINT16	Max Instance
3	get	UINT16	Num of Instances

Table 4- 23 Instance Attribute

No.	Service	Type	Name	Value/explanation
1	get	UINT32	Interface Speed	0: link down, 10: 10 Mbps, 100: 100 Mbps
2	get		Interface Flags	Bit 1: Link-Status Bit 2: Duplex Mode (0: halb duplex, 1 duplex) Bit 3 ... 5: Automatic state identification Bit 6: Reset required Bit 7: Local hardware fault (0 = ok)
3	get	ARRAY	Physical Address	r8935 Ethernet MAC address
4	get_and_clear	Struct of	Interface Counters	Optional, required if the "Media Counters Attribute" is implemented.
		UINT32	In Octets	Received octets
		UINT32	In Ucast Packets	Received Unicast packets
		UINT32	In NUcast Packets	Received non-Unicast packets
		UINT32	In Discards	Incoming packets, not processed
		UINT32	In Errors	Incoming packets with errors
		UINT32	In Unknown Protos	Incoming packets with unknown protocol
		UINT32	Out Octets	Sent octets
		UINT32	Out Ucast Packets	Sent Unicast packets
		UINT32	Out NUcast packets	Sent non-Unicast packets
		UINT32	Out Discards	Outgoing packets, not processed
UINT32	Out Errors	Outgoing packets, with errors		

4.5 Supported objects

No.	Service	Type	Name	Value/explanation
5	get_and_clear	Struct of	Media Counters	Media-specific counters
		UINT32	Alignment Errors	Structure received, which does not match the number of octets
		UINT32	FCS Errors	Structure received, which does not pass the FCS check
		UINT32	Single Collisions	Structure successfully transmitted, precisely one collision
		UINT32	Multiple Collisions	Structure successfully transmitted, several collisions
		UINT32	SQE Test Errors	Number of SQE errors
		UINT32	Deferred Transmissions	First transmission attempt delayed
		UINT32	Late Collisions	Number of collisions that occurred delayed by 512 bit timers to the request
		UINT32	Excessive Collisions	Transmission unsuccessful as a result of intensive collisions
		UINT32	MAC Transmit Errors	Transmission unsuccessful as a result of an internal MAC sublayer transmission error.
		UINT32	Carrier Sense Errors	Times that the carrier sense condition was lost or never asserted when attempting to transmit a frame
		UINT32	Frame Too Long	Structure too large
6	get, set	Struct of	Interface Control	
		UINT16	Control Bits	
		UINT16	Forced Interface Speed	
10	get	String	Interface_Label	Interface-Label

Parameter Object, Instance Number: 401 hex**Supported services**

- | | | | |
|-------|---|----------|---|
| Class | <ul style="list-style-type: none"> • Get Attribute all | Instance | <ul style="list-style-type: none"> • Get Attribute all • Set Attribute single |
|-------|---|----------|---|

Table 4- 24 Class Attribute

No.	Service	Type	Name
1	get	UINT16	Revision
2	get	UINT16	Max Instance
3	get	UINT16	Num of Instances

Cyclic communication is established via parameter object 401.

Example: Read parameter 2050[10] (connector output to interconnect the PZD received from the fieldbus controller)

Get Attribute single function with the following values:

- Class = 401 hex
- Instance = 2050 = 802 hex \triangleq parameter number
- Attribute = 10 = A hex \triangleq Index 10

Example: Parameter 1520[0] writing (upper torque limit)

Set Attribute single function with the following values:

- Class = 401 hex
- Instance = 1520 = 5F0 hex \triangleq parameter number
- Attribute = 0 = 0 hex \triangleq index 0
- Data = 500.0 (value)

4.5 Supported objects

4.5.1 Supported ODVA AC/DC assemblies

Overview

Number		required/ optional	Type	Name
hex	dec			
14 hex	20	Required	Sending	Basic Speed Control Output
46 hex	70	Required	Receiving	Basic Speed Control Input

Assembly Basic Speed Control, Instance Number: 20, type: Output

Byte	Bit 7	Bit 6	Bit 5	Bit 4	Bit 3	Bit 2	Bit 1	Bit 0
0						Fault Reset		RUN Forward
1								
2	Speed Reference (Low Byte)							
3	Speed Reference (High Byte)							

Assembly Basic Speed Control, Instance Number: 70, type: Input

Byte	Bit 7	Bit 6	Bit 5	Bit 4	Bit 3	Bit 2	Bit 1	Bit 0
0						Running Forward		Faulted
1								
2	Speed Actual (Low Byte)							
3	Speed Actual (High Byte)							

4.6 Create generic I/O module

For certain controllers, or if you wish to use the SINAMICS profile, you cannot use the EDS file provided by Siemens. In these cases, you must create a generic I/O module in the control system for the cyclic communication.

Procedure

1. In your control, create a generic device with Ethernet/IP functionality.
2. Enter the lengths for the process data for cyclic communication which you selected in Startdrive, r2067 [0] (input), r2067 [1] (output) into the new device, for example: Standard telegram 2/2 .
4 ms is supported as the minimum value for RPI (Requested Packet Interval).
3. In Startdrive, set the same values for IP address, subnet mask, default gateway and name of the station as in the control system.



Configuring communication via EtherNet/IP (Page 86).

You have created a generic I/O module for cyclic communication with the inverter.



You can find a detailed description of how to create a generic I/O module at the following link:



Generating an EDS file

<http://support.automation.siemens.com/WW/view/en/82843076>

4.7 The inverter as an Ethernet station

Integrating an inverter into an Ethernet network (assigning an IP address)

Procedure

1. Set p8924 (PN DHCP mode) = 2 oder 3
 - p8924 = 2: The DHCP server assigns the IP address based on the MAC address of the inverter.
 - p8924 = 3: The DHCP server assigns the IP address based on the device name of the inverter.
2. Save the settings with p8925 = 2. The next time that the inverter switches on, it retrieves the IP address, and you can address the inverter as Ethernet node.

Note

Immediate switchover without restart

The switchover to DHCP is performed immediately and without a restart if the change is carried out with the Ethernet/IP command "Set Attribute Single" (class F5 hex, attribute 3). The following options are available:

- via an Ethernet/IP controller
- via an Ethernet/IP commissioning tool

You have now integrated the inverter into Ethernet.



Displays

r8930: Device name of the inverter

r8934: Operating mode, PN or DHCP

r8935: MAC address

Additional information

You can find information about parameters and messages (A08565) in the List Manual of the inverter.



Overview of the manuals (Page 232).

Additional options of integrating inverters into Ethernet

You also have the option of integrating the inverter into Ethernet using Proneta or STEP7, for example.

Here is the example of the "Edit Ethernet station" screen form from Step 7, which you can use to make the required settings.



The screenshot shows a software dialog box titled "Ethernet-Teilnehmer bearbeiten". It contains several sections for configuring an Ethernet station. The "Ethernet Teilnehmer" section has a "MAC-Adresse" input field and a "Durchsuchen..." button. The "IP-Konfiguration einstellen" section has two radio button options: "IP-Parameter verwenden" (which is selected) and "IP-Adresse von einem DHCP-Server beziehen". Under "IP-Parameter verwenden", there are input fields for "IP-Adresse" and "Subnetzmaske", and radio buttons for "Keinen Router verwenden" (selected) and "Router verwenden" (with an associated "Adresse" field). Under "IP-Adresse von einem DHCP-Server beziehen", there are radio buttons for "Client-ID", "MAC-Adresse", and "Gerätename", and a "Client-ID" input field. Below this is an "IP-Konfiguration zuweisen" button. The "Gerätename vergeben" section has a "Gerätename" input field and a "Name zuweisen" button. The "Rücksetzen auf Werkseinstellungen" section has a "Zurücksetzen" button. At the bottom of the dialog are "Schließen" and "Hilfe" buttons.

You can find the required settings for the inverter as Ethernet node in The inverter with PROFINET interface as Ethernet node. (Page 70).

Communication via RS485

5

Table 5- 1 Assignment table - fieldbus systems via RS485

Inverter/Control Unit		Fieldbus connection for			
		USS	Modbus RTU	BACnet MS/TP	P1
	G120				
	• CU230P-2 HVAC	✓	✓	✓	✓
	• CU230P-2 BT	✓	✓	✓	✓
	• CU240B-2	✓	✓	---	---
	• CU240E-2	✓	✓	---	---
	• CU240E-2 F	✓	✓	---	---
	• CU250S-2	✓	✓	---	---
	G120C				
	• G120C USS/MB	✓	✓	---	---
	G110M				
	• CU240M USS	✓	✓	---	---

5.1 Inverter with RS485 interface

You can find the connectors and the connector assignments of the RS485 interface in the following tables.

Table 5- 2 Assignment table







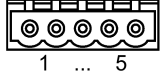

Inverter/Control Unit		Connection via		
		X128 	X03, in (M12) 	X04, out (M12) 
	G120			
	• CU230P-2 HVAC	x		
	• CU230P-2 BT	x		
	• CU240B-2	x		
	• CU240E-2	x		
	• CU240E-2 F	x		
	G120C			
	• G120C USS/MB	x		
	G110M			
	• CU240M USS		x	x

Table 5- 3 Pin assignment

Signal	X128 	X03, in (M12) 	X04, out (M12) 
Not assigned	5	1/3	1/3
RS485N, receive and transmit (-)	3	---	---
RS485N, receive	---	2	---
RS485N, transmit (-)	---	---	2
RS485P, receive and transmit (+)	2	---	---
RS485P, receive	---	4	---
RS485P, transmit (+)	---	---	4
0 V, reference potential	1	5	5
Cable shield	4	---	---

5.2 Integrating inverters into a bus system via the RS485 interface

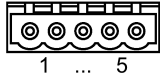
Connecting to a network via RS485

Connect the inverter to the fieldbus via the RS485 interface.

The RS485 connector has short-circuit proof, isolated pins.

You must switch-in the bus-terminating resistor for the first and last nodes.

You can find the position of the RS485 connector and the bus terminating resistor in the operating instructions for the inverter or the Control Unit.

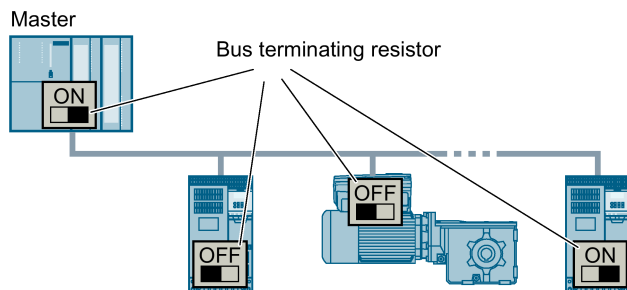

The precondition for error-free communications is that the first and last station are supplied with power.

Communications are maintained if you withdraw individual slaves from the bus without interrupting the cable (this is not possible for inverters with a high degree of protection).

Communication with the control, even when the line voltage is switched off

If, in your plant or system, communication with the control system should continue to function even when the line voltage is switched off, then you must externally supply the inverter/Control Unit with 24 V DC. To do this, use terminals 31 and 32 – or connector X01. You can find additional details in the operating instructions for the inverter or the Control Unit.

5.3 Communication via USS

The USS protocol is a serial data link between a master and up to a maximum of 31 slaves.

A master is, for example:

- A programmable logic controller (e.g. SIMATIC S7-200)
- A PC

The inverter is always a slave.

The maximum cable length is:

- 1200 m for a baud rate up to 38400 bit/s and maximum of 32 nodes
- 1000 m for a baud rate of 187500 bit/s and a maximum of 30 nodes

Additional information on how to connect the inverter to a USS fieldbus:  Integrating inverters into a bus system via the RS485 interface (Page 110).

5.3.1 Basic settings for communication

Overview

Depending on the inverter, you have the following options for setting communication via the USS:

- For all inverters with an RS485 interface:
21 "USS Fieldbus"
- For inverters with a CU230P-2 HVAC / CU230P-2 BT
108 "BT Mac 8: USS fieldbus"

For additional information, please refer to the operating instructions of your inverter.

 Overview of the manuals (Page 232).

Procedure with default setting 21 "USS Fieldbus"

Proceed as follows to set communication via USS:

1. Activate communication via the RS485 interface using one of the following options:
 - With Startdrive during commissioning in step "Default setting of setpoint/command sources":
21: USS fieldbus
 - With the BOP-2 during basic commissioning under step "MAc PAr P15":
FB USS
 - Via the parameter number:
p0015 = 21
2. Set the bus protocol via p2030:
p2030 = 1
3. Set the inverter address.

4. Make additional changes based on the parameters listed in the following section.
5. If you are working with Startdrive, back up the settings so they are not lost if the power fails.

You have now made the settings for communication via the USS.

□

5.3.1.1 Setting the address

Valid address area: 0 ... 31

You have the following options for setting the address:

- Using the address switch on the Control Unit:

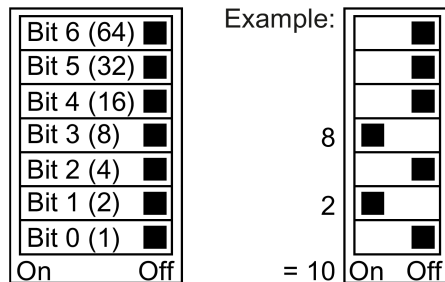

Figure 5-1 Address switch with example for bus address 10

The address switch has priority over the other settings.

- Using Startdrive or an operator panel via parameter p2021 (default setting: p2021 = 0) it is only possible to change p2021 if an invalid address is set in the address switch.

If you are working with Startdrive, back up the settings so they are not lost if the power fails.

You can find the position of the address switch in the operating instructions for the inverter.

 Manuals and technical support (Page 232)

Activating the changed bus address

Procedure

1. Set the address as described above.
2. Switch off the inverter power supply.
3. Wait until all LEDs on the inverter are dark.
4. Switch on the inverter power supply again.

Your settings become effective after switching on.

You have now set the bus address.

□

5.3.1.2 Parameters to set communication via USS

Fieldbus protocol selection p2030 = 1 (USS)

Baud rate p2020 = 8, 38400 bit/s

Setting range: 2400 bit/s ... 187500 bit/s

Fieldbus analog outputs p0791[0 ... 1]

Parameter to interconnect the analog outputs for control via the fieldbus

Fieldbus interface USS PZD number p2022 = 2

Setting the number of 16-bit words in the PZD part of the USS telegram
Setting range: 0... 8 (0 ... 8 words)

Fieldbus interface USS PKW number, p2023 = 127

Setting the number of 16-bit words in the PKW part of the USS telegram
Setting range:

- 0, 3, 4: fixed length with 0, 3 or 4 words
- 127: variable lengths

Fieldbus error statistics r2029

Displaying receive errors at the fieldbus interface

Fieldbus monitoring time p2040 = 100 ms

Setting range: 0 ms ... 1999999 ms

The more slaves that are connected in the network, the longer the fieldbus monitoring time must be.

If process data is not transferred within one cycle of the fieldbus monitoring time, then the inverter shuts down with fault F01910.

p2040 = 0 ⇒ bus monitoring deactivated.

5.3.2 Telegram structure

Overview

A USS telegram comprises a series of elements with a defined sequence. Each element contains 11 bits.

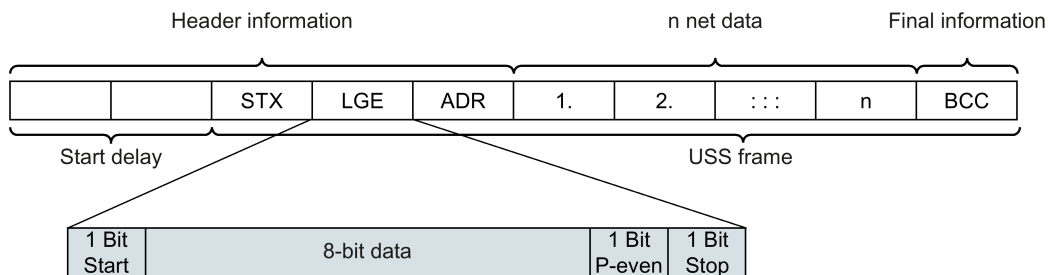



Figure 5-2 Structure of a USS telegram

Telegram part	Description																
Start delay / re- sponse delay	There is always a start and/or response delay between two telegrams.  Time-out and other errors (Page 123)																
STX	An ASCII character (02 hex) indicates the beginning of the message.																
LGE	The telegram length "LGE" is calculated as follows: LGE = user data (n bytes) + ADR (1 byte) + BCC (1 byte)																
ADR	<table border="1" style="margin-left: auto; margin-right: auto;"> <tr> <td style="text-align: center;">7</td> <td style="text-align: center;">6</td> <td style="text-align: center;">5</td> <td style="text-align: center;">4</td> <td style="text-align: center;">3</td> <td style="text-align: center;">2</td> <td style="text-align: center;">1</td> <td style="text-align: center;">0</td> </tr> <tr> <td style="text-align: center;">Special telegram</td> <td style="text-align: center;">Mirror telegram</td> <td style="text-align: center;">Broadcast bit</td> <td></td> <td></td> <td colspan="2" style="text-align: center;">Address</td> <td></td> </tr> </table> <ul style="list-style-type: none"> • Bit 7 = 0: Normal data exchange. Bit 7 =1, to transfer telegrams that require a net data structure different from the device profile. • Bit 6 = 0: Normal data exchange. Bit 6 = 1: Testing the bus connection: The converter returns the telegram unchanged to the master. • Bit 5 = 0: Normal data exchange. (Bit 5 = 1: Not supported in the converter.) • Bits 0 ... 4: Address of the converter. 	7	6	5	4	3	2	1	0	Special telegram	Mirror telegram	Broadcast bit			Address		
7	6	5	4	3	2	1	0										
Special telegram	Mirror telegram	Broadcast bit			Address												
Net data	 User data range of the USS telegram (Page 115).																
BCC	Checksum (exclusive or) across all telegram bytes – with the exception of BCC.																

5.3.3 User data range of the USS telegram

The user data area consists of the following elements:

- Parameter channel (PIV) for writing and reading parameter values
- Process data (PZD) for controlling the drive.

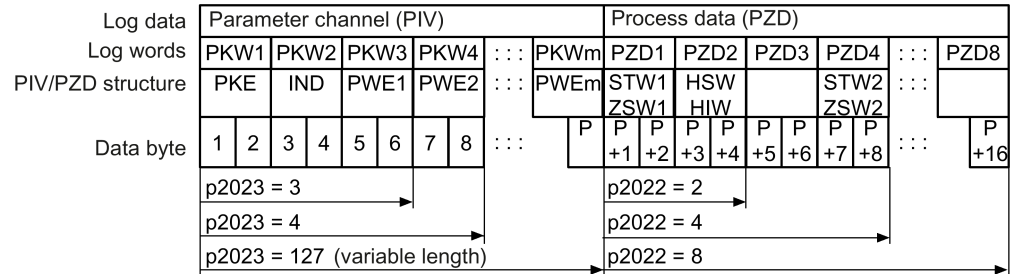

Figure 5-3 USS telegram - user data structure

Parameter channel

In parameter p2023 you specify the parameter channel length.

Parameter channel with fixed and variable length

- p2023 = 0
With this setting, no parameter values are transferred.
- p2023 = 3
You can select this setting if you only want to read or write 16-bit data or alarm signals.
- p2023 = 4:
If you want to read or write 32-bit values (for example indexed parameters or bit parameters, e.g. r0722.2), then this setting is required. In this case, the send or receive telegram always contains four words, even if only three would be required. The values are enter right-justified in the 4th word.
- p2023 = 127:
If you set p2023 = 27 (variable length), the send and response telegrams are as long as the task actually requires.

Process data

Parameter p2022 defines the length for the process data. You can transfer up to eight process data items in one telegram (p2022 = 0 ... 8). For p2022 = 0, no process data is transferred.

5.3.4 USS parameter channel

Structure of the parameter channel

Depending on the setting in p2023, the parameter channel has a fixed length of three or four words, or a variable length, depending on the length of the data to be transferred.

1. and 2nd word contain the parameter number and index as well as the type of job (read or write). The other words of the parameter channel contain parameter contents. The parameter contents can be 8-bit values, 16-bit values (such as baud rate) or 32-bit values (e.g. CO parameters). The parameter contents are entered right justified in the word with the highest number. Words that are not required are assigned 0.

Bit 11 in the 1st word is reserved and is always assigned 0.

The diagram shows a parameter channel that is four words long.

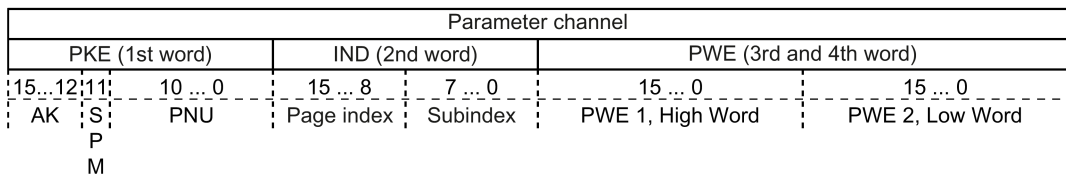

You can find examples of telegrams at the end of this section.

AK: Request and response IDs

Bits 12 ... 15 of the 1st The parameter channel words contain the request and response identifier AK.

Table 5- 4 Request identifiers, control → inverter

AK	Description	Response identifier	
		positive	negative
0	No request	0	7 / 8
1	Request parameter value	1 / 2	7 / 8
2	Change parameter value (word)	1	7 / 8
3	Change parameter value (double word)	2	7 / 8
4	Request descriptive element ¹⁾	3	7 / 8
6 ²⁾	Request parameter value (field) ¹⁾	4 / 5	7 / 8
7 ²⁾	Change parameter value (field, word) ¹⁾	4	7 / 8
8 ²⁾	Change parameter value (field, double word) ¹⁾	5	7 / 8
9	Request number of field elements	6	7 / 8

1) The required element of the parameter is specified in IND (2nd word).

2) The following request IDs are identical: 1 ≡ 6, 2 ≡ 7 3 ≡ 8.

We recommend that you use identifiers 6, 7, and 8.

Table 5- 5 Response identifiers, inverter → control

AK	Description
0	No response
1	Transfer parameter value (word)
2	Transfer parameter value (double word)
3	Transfer descriptive element ¹⁾
4	Transfer parameter value (field, word) ²⁾
5	Transfer parameter value (field, double word) ²⁾
6	Transfer number of field elements
7	Inverter cannot process the request. In the most significant word of the parameter channel, the inverter sends an error number to the control, refer to the following table.
8	No master controller status / no authorization to change parameters of the parameter channel interface

¹⁾ The required element of the parameter is specified in IND (2nd word).

²⁾ The required element of the indexed parameter is specified in IND (2nd word).

Table 5- 6 Error numbers for response identifier 7

No.	Description
00 hex	Illegal parameter number (access to a parameter that does not exist)
01 hex	Parameter value cannot be changed (change request for a parameter value that cannot be changed)
02 hex	Lower or upper value limit exceeded (change request with a value outside the value limits)
03 hex	Incorrect subindex (access to a subindex that does not exist)
04 hex	No array (access with a subindex to non-indexed parameters)
05 hex	Incorrect data type (change request with a value that does not match the data type of the parameter)
06 hex	Setting not permitted, only resetting (change request with a value not equal to 0 without permission)
07 hex	Descriptive element cannot be changed (change request to a descriptive element error value that cannot be changed)
0B hex	No master control (change request but with no master control, see also p0927.)
0C hex	Keyword missing
11 hex	Request cannot be executed due to the operating state (access is not possible for temporary reasons that are not specified)
14 hex	Inadmissible value (change request with a value that is within the limits but which is illegal for other permanent reasons, i.e. a parameter with defined individual values)
65 hex	Parameter number is currently deactivated (depending on the mode of the inverter)
66 hex	Channel width is insufficient (communication channel is too small for response)
68 hex	Illegal parameter value (parameter can only assume certain values)
6A hex	Request not included / task is not supported (the valid request identifications can be found in table "Request identifications controller → inverter")
6B hex	No change access for a controller that is enabled. (The operating state of the inverter prevents a parameter change)
86 hex	Write access only for commissioning (p0010 = 15) (operating state of the inverter prevents a parameter change)
87 hex	Know-how protection active, access locked
C8 hex	Change request below the currently valid limit (change request to a value that lies within the "absolute" limits, but is however below the currently valid lower limit)
C9 hex	Change request above the currently valid limit (example: a parameter value is too large for the inverter power)
CC hex	Change request not permitted (change is not permitted as the access code is not available)

5.3.4.1 Telegram examples, length of the parameter channel = 4

Read request: Read out serial number of the Power Module (p7841[2])

To obtain the value of the indexed parameter p7841, you must fill the telegram of the parameter channel with the following data:

- **PKE, bit 12 ... 15 (AK): = 6** (request parameter value (field))
- **PKE, bit 0 ... 10 (PNU): = 1841** (Parameter number without offset)
 Parameter number = PNU + offset (page index)
 (7841 = 1841 + 6000)
- **IND, bit 8 ... 15 (page index): = 90 hex** (offset 6000 \cong 90 hex)
- **IND, bit 0 ... 7 (subindex): = 2** (Index of the parameter)
- Because you want to read the parameter value, words 3 and 4 in the parameter channel for requesting the parameter value are irrelevant. They should be assigned a value of 0, for example.

Parameter channel						
PKE (1st word)		IND, 2nd word		PWE1 - high, 3rd word	PWE2 - low, 4th word	
15...12	11 ... 10	15 ... 8	7 ... 0	15 ... 0	15 ... 10	9 ... 0
AK	Parameter number	Page index	Subindex	Parameter value	Drive Object	Index
01110	011100110001	10010000	00000010	00000000000000000000	00000000	000000000000

Figure 5-4 Telegram for a read request from p7841[2]

Write request: Changing the automatic restart mode (p1210)

Parameter p1210 defines the automatic restart mode:

- **PKE, bit 12 ... 15 (AK): = 7** (change parameter value (field, word))
- **PKE, bit 0 ... 10 (PNU): = 4BA hex** (1210 = 4BA hex, no offset, as 1210 < 1999)
- **IND, bit 8 ... 15 (page index): = 0 hex** (offset 0 corresponds to 0 hex)
- **IND, bit 0 ... 7 (subindex): = 0 hex** (parameter is not indexed)
- **PWE1, bit 0 ... 15: = 0 hex**
- **PWE2, bit 0 ... 15: = 1A hex** (26 = 1A hex)

Parameter channel						
PKE, 1st word		IND, 2nd word		PWE1 - high, 3rd word	PWE2 - low, 4th word	
15...12	11 ... 10	15 ... 8	7 ... 0	15 ... 0	15 ... 0	
AK	Parameter number	Page index	Subindex	Parameter value (bit 16 ... 31)	Parameter value (bit 0 ... 15)	
01110	100100111010	00000000	00000000	00000000000000000000	00000000	00000000000011010

Figure 5-5 Telegram, to activate the automatic restart with p1210 = 26

Write request: Assign digital input 2 with the function ON/OFF1 (p0840[1] = 722.2)

In order to link digital input 2 with ON/OFF1, you must assign parameter p0840[1] (source, ON/OFF1) the value 722.2 (DI 2). To do this, you must fill the telegram of the parameter channel as follows:

- **PKE, bit 12 ... 15 (AK): = 7 hex** (change, parameter value (field, word))
- **PKE, bit 0 ... 10 (PNU): = 348 hex** (840 = 348 hex, no offset, as 840 < 1999)
- **IND, bit 8 ... 15 (page index): = 0 hex** (offset 0 \pm 0 hex)
- **IND, bit 0 ... 7 (subindex): = 1 hex** (command data set, CDS1 = index1)
- **PWE1, bit 0 ... 15: = 2D2 hex** (722 = 2D2 hex)
- **PWE2, bit 10 ... 15: = 3f hex** (drive object - for SINAMICS G120, always 63 = 3f hex)
- **PWE2, bit 0 ... 9: = 2 hex** (index or bit number of the parameter: DI 2 = r0722.2)

Parameter channel																																																								
PKE, 1st word						IND, 2nd word						PWE1 - high, 3rd word						PWE2 - low, 4th word																																						
15...12		10 ... 0				15 ... 8			7 ... 0			15 ... 0						15 ... 10			9 ... 0																																			
AK		Parameter number				Page index			Subindex			Parameter value						Drive Object			Index																																			
0	1	1	1	0	0	1	1	0	1	0	0	1	0	0	0	0	0	0	0	0	0	0	0	0	0	0	1	0	0	0	0	0	1	0	1	1	0	1	0	0	1	0	1	1	1	1	1	0	0	0	0	0	0	0	1	0

Figure 5-6 Telegram, to assign DI 2 with ON/OFF1

5.3.5 USS process data channel (PZD)

Description

The process data channel (PZD) contains the following data depending on the transmission direction:

- Control words and setpoints for the slave
- Status words and actual values for the master.

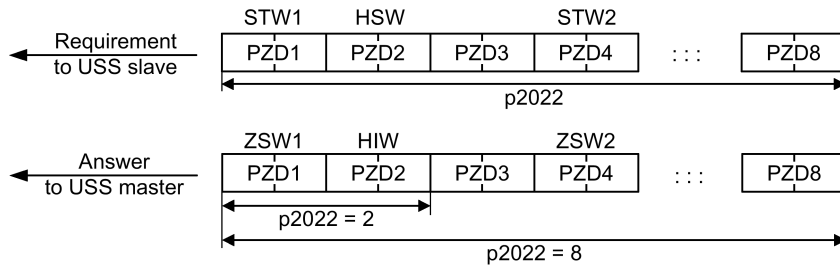

Figure 5-7 Process data channel

The first two words are:

- Control 1 (STW1) and main setpoint (HSW)
- Status word 1 (ZSW1) and main actual value (HIW)

If p2022 is greater than or equal to 4, then the converter receives the additional control word (STW2).

You define the sources of the PZD using parameter p2051.

For further information, please refer to the List Manual.

5.3.6 Time-out and other errors

You require the telegram runtimes in order to set the telegram monitoring. The character runtime is the basis of the telegram runtime:

Table 5- 8 Character runtime

Baud rate in bit/s	Transmission time per bit	Character run time (= 11 bits)
9600	104.170 μ s	1.146 ms
19200	52.084 μ s	0.573 ms
38400	26.042 μ s	0.286 ms
57600	17.361 μ s	0.191 ms
115200	8.681 μ s	0.095 ms

The telegram runtime is longer than just purely adding all of the character runtimes (=residual runtime). You must also take into consideration the character delay time between the individual characters of the telegram.

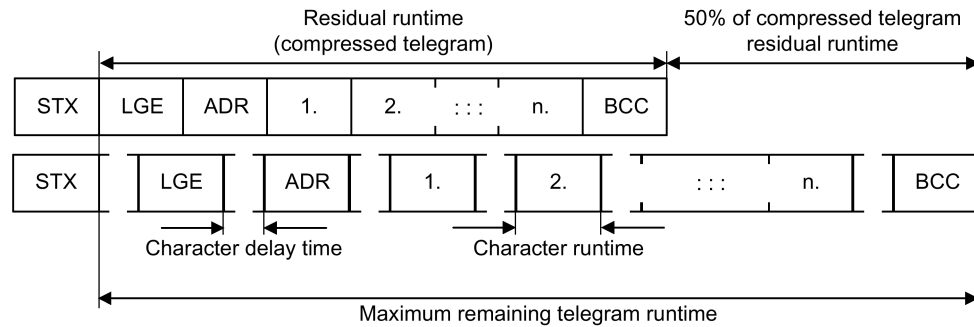

Figure 5-8 Telegram runtime as the sum of the residual runtime and character delay times

The total telegram runtime is always less than 150% of the pure residual runtime.

Before each request telegram, the master must maintain the start delay. The start delay must be $> 2 \times$ character runtime.

The slave only responds after the response delay has expired.

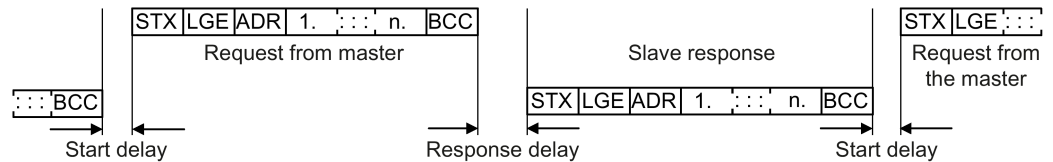

Figure 5-9 Start delay and response delay

The duration of the start delay must at least be as long as the time for two characters and depends on the baud rate.

Table 5- 9 Duration of the start delay

Baud rate in bit/s	Transmission time per character (= 11 bits)	Min. start delay
9600	1.146 ms	> 2.291 ms
19200	0.573 ms	> 1.146 ms
38400	0.286 ms	> 0.573 ms
57600	0.191 ms	> 0.382 ms
115200	0.095 ms	> 0.191 ms

Note: The character delay time must be shorter than the start delay.

Telegram monitoring of the master

With your USS master, we recommend that the following times are monitored:

- Response delay: Response time of the slave to a request from the master
The response delay must be < 20 ms, but longer than the start delay
- Telegram runtime: Transmission time of the response telegram sent from the slave

Telegram monitoring of the inverter

The inverter monitors the time between two requests of the master. Parameter p2040 defines the permissible time in ms. If a time p2040 ≠ 0 is exceeded, then the inverter interprets this as telegram failure and responds with fault F01910.

150% of the residual runtime is the guide value for the setting of p2040, i.e. the telegram runtime without taking into account the character delay times.

For communication via USS, the inverter checks bit 10 of the received control word 1. If the bit is not set when the motor is switched on ("Operation"), the inverter responds with fault F07220.

5.4 Communication using Modbus RTU

Overview of communication using Modbus

The Modbus protocol is a communication protocol based on a client/server architecture. Selected parameters and process data are exchanged in a cyclic access via the Modbus register.

Modbus offers three transmission modes:

- **Modbus ASCII** - via a serial interface
data in the ASCII code. The data throughput is lower compared to RTU.
- **Modbus RTU** - via a serial interface
data in the binary format. The data throughput is greater than in ASCII code.
- **Modbus TCP** - via Ethernet
Data are transferred as TCP/IP packages TCP port 502 is reserved for Modbus TCP.

SINAMICS G120 inverters support Modbus RTU.

General information about communication using Modbus RTU

Communication using Modbus RTU takes place over the RS485 interface with a maximum of 247 slaves.

- The maximum cable length is 1200 m.
- To polarize the receive and transmit lines, there are two 100 k Ω resistors, which you can switch in or switch out using the DIP switch next to the fieldbus interface.

Note

It is not permitted to change over the units

The "Unit switchover" function – for details see the operating instructions of the Control Unit – is not permissible with this bus system!

5.4.1 Basic settings for communication

Overview

Depending on the particular inverter, you have the following options when setting communication via Modbus RTU:

- For all inverters with an RS485 interface:
21 "USS Fieldbus"
- For inverters with a CU230P-2 HVAC / CU230P-2 BT
109 "BT Mac 9: Modbus RTU Fieldbus"

For additional information, please refer to the operating instructions of your inverter.



Overview of the manuals (Page 232).

Procedure with default setting 21 "USS Fieldbus"

Proceed as follows to set communication via Modbus RTU:

1. Activate communication via the RS485 interface using one of the following options:
 - With Startdrive during commissioning step "Default setting of setpoint/command sources":
21: USS fieldbus
 - With the BOP-2 during the basic commissioning under step "MAc PAr P15":
FB USS
 - Via parameter number:
p0015 = 21
2. Set the bus protocol via p2030:
p2030 = 2
3. Set the inverter address.
4. Make additional changes based on the parameters listed in the following section.
5. If you are working with Startdrive, back up the settings so they are not lost if the power fails.

You have now made the settings for communication via Modbus.



5.4.1.1 Setting the address

Valid address area: 1 ... 247

You have the following options for setting the address:

- Using the address switch on the Control Unit from 1 ... 127:

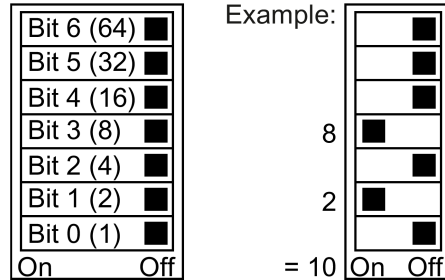



Figure 5-10 Address switch with example for bus address 10

The address switch has priority over the other settings.

- Using Startdrive or an operator panel via parameter p2021 from 1 ... 247 (default setting: p2021 = 1)
Setting via p2021 is only possible if address 0 is set in the address switch.

If you are working with Startdrive, back up the settings so they are not lost if the power fails.

You can find the position of the address switch in the operating instructions for the inverter.

 Manuals and technical support (Page 232)

Activating the changed bus address

Procedure

1. Set the address as described above.
2. Switch off the inverter power supply.
3. Wait until all LEDs on the inverter are dark.
4. Switch on the inverter power supply again.

Your settings become effective after switching on.

You have now set the bus address.

□

5.4.1.2 Parameters for Modbus communication settings

General settings

Fieldbus protocol selection p2030 = 2 (Modbus RTU)

Baud rate p2020 = 7, 19200 bit/s

Setting range: 4800 bit/s ... 187500 bit/s

Parity

In the factory, the Control Unit is set for controllers with even parity. You can adapt the parity at your controller using p2031:

- p2031 = 0: No parity
- p2031 = 1: Odd parity
- p2031 = 2: Parity even

Note

Number of stop bits

For No parity, the control sends 2 stop bits, for parity odd or parity even, only 1 stop bit

Modbus timing p2024[0 ... 2]

- **p2024[0]: Maximum slave telegram processing time:**
The time after which the slave must have sent a response to the master. 0 ms ... 10000 ms, factory setting = 6000 ms.
- **p2024[1]: Character delay time:**
Character delay time: Maximum permissible time between the individual characters in the Modbus frame. (Modbus standard processing time for 1.5 bytes).
- **p2024 [2]: Inter-telegram delay:**
maximum permissible time between Modbus telegrams. (Modbus standard processing time for 3.5 bytes).

Values for p2024 [1] and p2024 [2]

 Table 5-10 Baud rates, transmission times, and delays (Page 131).

Fieldbus monitoring time p2040 = 1000 ms

Setting range: 0 ms ... 1999999 ms

The more slaves that are connected in the network, the longer the fieldbus monitoring time must be.

If process data is not transferred within one cycle of the fieldbus monitoring time, then the inverter shuts down with fault F01910.

p2040 = 0 ⇒ bus monitoring deactivated.

Fieldbus error statistics r2029

Displaying receive errors at the fieldbus interface

Interconnecting analog outputs

If you set communication via Modbus (p2030 = 2), then the analog outputs of the inverter are internally interconnected with the fieldbus analog outputs:

- p0771[0] = 791[0]
- p0771[1] = 791[1].

The values for p0791[0] and p0791[1] are written via registers 40523 and 40524. Interconnections between parameter p0791 and other sources are rejected.

This means that the control outputs system-specific values via the analog outputs of the inverter.

However, if you still wish to display an inverter-specific value, then you must adapt the appropriate wiring.

Example

- AO 0 should display the value written via the control with register 40523. In this particular case, no other settings are required in the inverter.
- AO 1 should display the smoothed current actual value. To do this, you must set p0771[1] = 27 (r0027 smoothed current actual value).
In this case, a write access via register 40524 to p0791[1] results in a fault message in the control.

Note

Reset to the factory setting for Modbus

If you have set communication via Modbus (p2030 = 2), when restoring the factory settings, the analog outputs are again interconnected with p0771[0] = 791[0] and p0771[1] = 791[1].

5.4.2 Modbus RTU telegram

Description

For Modbus, there is precisely one master and up to 247 slaves. The master always starts the communication. Slaves send data when requested to do so by the master. Slave-to-slave communication is not possible. The inverter always operates as slave.

The following figure shows the structure of a Modbus RTU telegram.

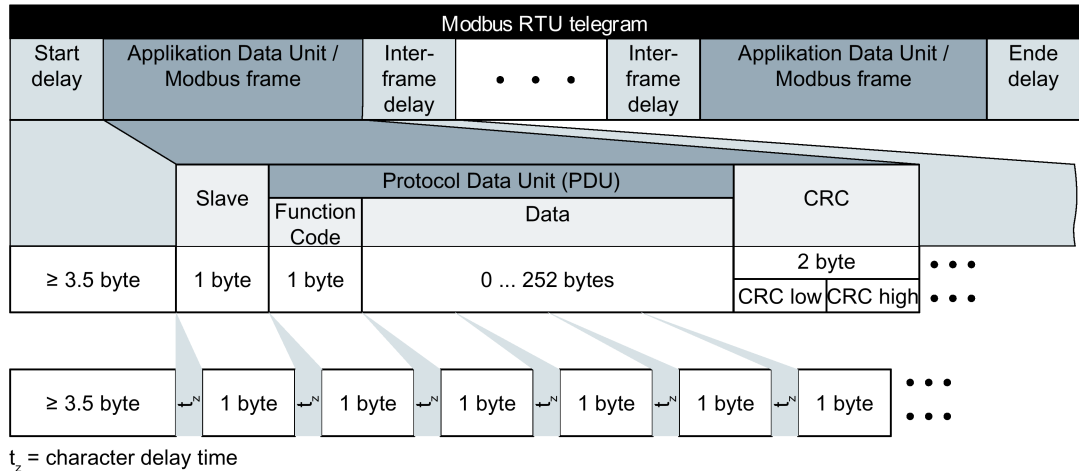

Figure 5-11 Modbus with delay times

The data area of the telegram is structured according to the mapping tables.

5.4.3 Baud rates and mapping tables

Permissible baud rates and telegram delay

The Modbus RTU telegram requires pauses for the following situations:

- for the start identifier
- for separating the individual frames
- for the end identifier

Minimum duration: Processing time for 3.5 bytes (can be set via p2024[2]).

A character delay time is also permitted between the individual bytes of a frame. Maximum duration: Processing time for 1.5 bytes (can be set via p2024[1]).

Table 5- 10 Baud rates, transmission times, and delays

Baud rate in bit/s (p2020)	Transmission time per character (11 bits)	Minimum pause between two telegrams (p2024[2])	Maximum pause between two bytes (p2024[1])
4800	2.292 ms	≥ 8.021 ms	≤ 3.438 ms
9600	1.146 ms	≥ 4.010 ms	≤ 1.719 ms
19200 (factory setting)	0.573 ms	≥ 1.75 ms	≤ 0.859 ms
38400	0.286 ms	≥ 1.75 ms	≤ 0.75 ms
57600	0.191 ms	≥ 1.75 ms	≤ 0.556 ms
76800	0.143 ms	≥ 1.75 ms	≤ 0.417 ms
93750	0.117 ms	≥ 1.75 ms	≤ 0.341 ms
115200	0.095 ms	≥ 1.75 ms	≤ 0.278 ms
187500	0.059 ms	≥ 1.75 ms	≤ 0.171 ms

Note

The factory setting for p2024[1] and p2024[2] is 0. The inverter defines the particular values depending on the protocol selection (p2030) or the baud rate.

Modbus register and Control Unit parameters



The inverter supports the subsequently listed registers. Error "Exception Code" is output if an attempt is made to access other registers.

Note

Read and write access to inverter data

R: read via FC03; W: write via FC06; R/W: read via FC03 or write via FC06

Table 5- 11 Assigning the Modbus register to the parameters - process data

Register	Description	Access	Scaling	Data / parameter
40100	Control word You can find details in function chart 9342 in the List Manual of the inverter.  Manuals (Page 232)	R/W	1	Process data 1
40101	Main setpoint	R/W	1	Process data 2
40110	Status word You can find details in function chart 9352 in the List Manual of the inverter.  Manuals (Page 232)	R	1	Process data 1
40111	Main actual value	R	1	Process data 2

5.4.4 Mapping tables - inverter data

Table 5- 12 Assigning the Modbus register to the parameters - On and outputs

Register	Description	Access	Unit	Scaling	ON/OFF text/value range		Data / parameter
Digital outputs							
40200	DO 0	R/W	--	1	HIGH	LOW	p0730, r747.0, p748.0
40201	DO 1	R/W	--	1	HIGH	LOW	p0731, r747.1, p748.1
40202	DO 2	R/W	--	1	HIGH	LOW	p0732, r747.2, p748.2
Analog outputs							
40220	AO 0	R	%	100	-100.0 ... 100.0		r0774.0
40221	AO 1	R	%	100	-100.0 ... 100.0		r0774.1
40523	AO 0	R/W	%	100	-199.99 ... 199.99		p0791.0
40524	AO 1	R/W	%	100	-199.99 ... 199.99		p0791.1
Digital inputs							
40240	DI 0	R	--	1	HIGH	LOW	r0722.0
40241	DI 1	R	--	1	HIGH	LOW	r0722.1
40242	DI 2	R	--	1	HIGH	LOW	r0722.2
40243	DI 3	R	--	1	HIGH	LOW	r0722.3
40244	DI 4	R	--	1	HIGH	LOW	r0722.4
40245	DI 5	R	--	1	HIGH	LOW	r0722.5
Analog inputs							
40260	AI 0	R	%	100	-300.0 ... 300.0		r0755 [0]
40261	AI 1	R	%	100	-300.0 ... 300.0		r0755 [1]
40262	AI 2	R	%	100	-300.0 ... 300.0		r0755 [2]
40263	AI 3	R	%	100	-300.0 ... 300.0		r0755 [3]

5.4 Communication using Modbus RTU

Table 5- 13 Assigning the Modbus register to the parameters - inverter data

Register	Description	Access	Unit	Scaling	ON-/OFF text/value range	Data / parameter
40300	Powerstack number	R	--	1	0 ... 32767	r0200
40301	Inverter firmware	R	--	1	z. B. 470	r0018 / 10000
40320	Rated power	R	kW	100	0 ... 327.67	r0206
40321	Current limit	R/W	A	10	10.0 ... 400.0	p0640
40322	Ramp-up time	R/W	s	100	0.00 ... 650.0	p1120
40323	Ramp-down time	R/W	s	100	0.00 ... 650.0	p1121
40324	Reference speed	R/W	RPM	1	6 ... 32767	p2000
Inverter diagnostics						
40340	Speed setpoint	R	RPM	1	-16250 ... 16250	r0020
40341	Actual speed value	R	RPM	1	-16250 ... 16250	r0022
40342	Output frequency	R	Hz	100	- 327.68 ... 327.67	r0024
40343	Output voltage	R	V	1	0 ... 32767	r0025
40344	DC-link voltage	R	V	1	0 ... 32767	r0026
40345	Current actual value	R	A	100	0 ... 163.83	r0027
40346	Actual torque value	R	Nm	100	- 325.00 ... 325.00	r0031
40347	Actual active power	R	kW	100	0 ... 327.67	r0032
40348	Energy consumption	R	kWh	1	0 ... 32767	r0039
40349	Control priority	R	--	1	HAND AUTO	r0807

Table 5- 14 Assigning the Modbus register to the parameters - fault diagnostics

Register	Description	Access	Unit	Scaling	ON-/OFF text/value range	Data / parameter
40400	Failure number, index 0	R	--	1	0 ... 32767	r0947 [0]
40401	Failure number, index 1	R	--	1	0 ... 32767	r0947 [1]
40402	Failure number, index 2	R	--	1	0 ... 32767	r0947 [2]
40403	Fault number, index 3	R	--	1	0 ... 32767	r0947 [3]
40404	Fault number, index 4	R	--	1	0 ... 32767	r0947 [4]
40405	Fault number, index 5	R	--	1	0 ... 32767	r0947 [5]
40406	Fault number, index 6	R	--	1	0 ... 32767	r0947 [6]
40407	Fault number, index 7	R	--	1	0 ... 32767	r0947 [7]
40408	Alarm number	R	--	1	0 ... 32767	r2110 [0]
40409	Actual alarm code	R	--	1	0 ... 32767	r2132
40499	PRM ERROR code	R	--	1	0 ... 255	--

Table 5- 15 Assigning the Modbus register to the parameters - technology controller

Register	Description	Access	Unit	Scaling	ON/OFF text/value range	Data / parameter
40500	Technology controller enable	R/W	--	1	0 ... 1	p2200, r2349.0
40501	Technology controller MOP	R/W	%	100	-200.0 ... 200.0	p2240
Technology controller adjustment						
40510	Time constant for actual-value filters of the technology controller	R/W	--	100	0.00 ... 60.0	p2265
40511	Scaling factor for actual value of the technology controller	R/W	%	100	0.00 ... 500.00	p2269
40512	Proportional amplification of the technology controller	R/W	--	1000	0.000 ... 65.000	p2280
40513	Integral time of the technology controller	R/W	s	1	0 ... 60	p2285
40514	Time constant D-component of the technology controller	R/W	--	1	0 ... 60	p2274
40515	Max. limit of technology controller	R/W	%	100	-200.0 ... 200.0	p2291
40516	Min. limit technology controller	R/W	%	100	-200.0 ... 200.0	p2292

Table 5- 16 Assigning the Modbus register to the parameters - PID diagnostics

Register	Description	Access	Unit	Scaling	ON/OFF text/value range	Data / parameter
40520	Effective setpoint acc. to internal technology controller MOP ramp-function generator	R	%	100	-100.0 ... 100.0	r2250
40521	Actual value of technology controller after filter	R	%	100	-100.0 ... 100.0	r2266
40522	Output signal technology controller	R	%	100	-100.0 ... 100.0	r2294

Table 5- 17 Modbus register for communication via DS47

Register	Description	Access	Unit	Scaling	Data / parameter
40601	DS47 Control	R/W	--	--	--
40602	DS47 header	R/W	--	--	--
40603	DS47 data 1	R/W	--	--	--
...			
40722	DS47 data 120	R/W	--	--	--

5.4.5 Acyclic communication via Modbus RTU

Acyclic communication or general parameter access is realized using the Modbus register 40601 ... 40722.

Acyclic communication is controlled using 40601. 40602 contains the function code (always = 47 = 2F hex) and the number of the following user data. User data are contained in registers 40603 ... 40722.

Overview of acyclic communication

Value in the register				Explanation
40601	40602	40603 ... 40722		
0	47	Write values for acyclic access
1	47	Request length [bytes]	Request data	Activate acyclic access
2	47	Response length [bytes]	Response data	Response for a successful request
2	47	0	Error code	Response for an erroneous request

Error codes

- 1 hex: Invalid Length (invalid length)
- 2 hex: Invalid State (in the actual inverter state, this action is not permitted)
- 3 hex: Invalid function code (FC ≠ 2F hex)
- 4 hex: Response not ready (the response has still not been issued)
- 5 hex: Internal Error (general system error)

Incorrect access operations to parameters via data set 47 are logged in registers 40603 ... 40722. The error codes are described in the PROFIdrive profile.

5.4.6 Write and read access using function codes

Basic structure of read and write access using function codes

Slave ID	Protocol Data Unit (PDU)		CRC	
	FC	Data	low	high
1 Byte	1 Byte	0 ... 252 Bytes	2 Byte	

Function codes used

For data exchange between the master and slave, predefined function codes are used for communication via Modbus.

The Control Unit uses the following Modbus function codes:

FC 03: Holding register to read data from the inverter

FC 06: Write single register to write to individual register

FC 16: Write to multiple registers to write to several registers

Structure of a read request via Modbus function code 03 (FC 03)

Any valid register address is permitted as the start address.

Via FC 03, the control can address more than one register with one request. The number of addressed registers is contained in bytes 4 and 5 of the read request.

Table 5- 18 Structure of a read request via slave number 17, example

Value	Byte	Description
11 h	0	Slave address
03 h	1	Function code
00 h	2	Register start address "High" (register 40110)
6D h	3	Register start address "Low"
00 h	4	Number of registers "High" (2 registers: 40110; 40111)
02 h	5	number of registers "Low"
xx h	6	CRC "Low"
xx h	7	CRC "High"

The response returns the corresponding data set:

Table 5- 19 Slave response to the read request, example

Value	Byte	Description
11 h	0	Slave address
03 h	1	Function code
04 h	2	Number of bytes (4 bytes are returned)
11 h	3	Data first register "High"
22 h	4	Data first register "Low"
33 h	5	Data second register "High"
44 h	6	Data second register "Low"
xx h	7	CRC "Low"
xx h	8	CRC "High"

Table 5- 20 Invalid read request

Read request	Inverter response
Invalid register address	Exception code 02 (invalid data address)
Read a write-only register	Telegram in which all values are set to 0.
Read a reserved register	
Controller addresses more than 125 registers	Exception code 03 (invalid data value)
The start address and the number of registers of an address are located outside of a defined register block	Exception code 02 (invalid data address)

Structure of a write request via Modbus function code 06 (FC 06)

Start address is the holding register address.

Via FC 06, with one request, only precisely one register can be addressed. The value, which is written to the addressed register, is contained in bytes 4 and 5 of the write request.

Table 5- 21 Structure of a write request for slave number 17, example

Value	Byte	Description
11 h	0	Slave address
06 h	1	Function code
00 h	2	Register start address "High" (write register 40100)
63 h	3	Register start address "Low"
55 h	4	Register data "High"
66 h	5	Register data "Low"
xx h	6	CRC "Low"
xx h	7	CRC "High"

The response returns register address (bytes 2 and 3) and the value (bytes 4 and 5), which the higher-level control had written to the register.

Table 5- 22 Slave response to the write request

Value	Byte	Description
11 h	0	Slave address
06 h	1	Function code
00 h	2	Register start address "High"
63 h	3	Register start address "Low"
55 h	4	Register data "High"
66 h	5	Register data "Low"
xx h	6	CRC "Low"
xx h	7	CRC "High"

Table 5- 23 Invalid write request

Write request	Inverter response
Incorrect address (a holding register address does not exist)	Exception Code 02 - invalid data address
Write to a "read-only" register	Exception Code 04 - device failure
Write to a reserved register	

For Exception Code 4, via the holding register 40499, you can read out the internal drive error code, which has occurred for the last parameter access via the holding register.

5.4.7 Acyclically read and write parameter via FC 16

Via FC 16, with one request, up to 122 registers can be written to directly one after the other, while for Write Single Register (FC 06) you must individually write the header data for each register.

Header

In addition to the slave address, enter the transfer type, the start address and the number of the following registers in the header.

User data

You control the access in the user data via register 40601.

In register 40602, you define the acyclic access as well as the length of the request data.

Register 40603 contains the request reference - it is defined by the user - and the access type -reading or writing.

From register 40603 and higher, the request aligns acyclic communication via data set 47 according to PROFIdrive.



PROFIDRIVE profile - Acyclic communication (Page 42).

Register 40604 contains the number of the drive object (for the CU230P-2 always 1) and the number of parameters that are read out or written to.

Register 40605 contains the attribute that you use to control whether you read out the parameter value or the parameter attribute. In the number of elements you specify how many indices are read.

5.4.7.1 Read parameter

Example: r0002 read acyclically

Table 5- 24 Write parameter request: Reading the parameter value of r0002 from slave number 17

Value	Byte	Description
11 h	0	Slave address
10 h	1	Function code (write multiple)
0258 h	2,3	Register start address
0007 h	4,5	Number of registers to be read (40601 ... 40607)
0E h	6	Number of data bytes (7 registers, each 2 bytes = 14 bytes)
0001 h	7,8	40601: DS47 Control = 1 (activate request)
2F0A h	9,10	40602: Function 2F h (47), request length 10 bytes (0A h)
8001 h	11,12	40603: Request reference = 80 h, request identifier = 1 h
0101 h	13,14	40604: DO-Id = 1, number of parameters = 1
1001 h	15,16	40605: Attribute, number of elements = 1
0002 h	17,18	40606: Parameter number = 2
0000 h	19,20	40607: Subindex = 0
xx h	21	CRC "Low"
xx h	22	CRC "High"

Table 5- 25 Start parameter request: Reading the parameter value of r0002 from slave number 17

Value	Byte	Description
11 h	0	Slave address
03 h	1	Function code (read)
0258 h	2,3	Register start address
0007 h	4,5	Number of registers to be read (40601 ... 40607)
0010 h	6,7	Number of registers
xx h	8	CRC "Low"
xx h	9	CRC "High"

Table 5- 26 Response for successful read operation

Value	Byte	Description
11 h	0	Slave address
03 h	1	Function code (read)
20 h	2	Number of following data bytes (20 h: 32 bytes $\hat{=}$ 16 registers)
0002 h	3,4	40601: DS47 Control = 2 (the request was executed)
2F08 h	5,6	40602: Function code 2F h (47), response lengths 8 bytes
8001 h	7,8	40603: Request reference mirrored = 80 h, response identifier = 1 (request parameter)
0101 h	9,10	40604: DO-ID = 1, number of parameters = 1
0301 h	11,12	40605: Format, number of elements = 1
001F h	13,14	40606: Parameter value = 1F h (31)
xx h	15	CRC "Low"
xx h	16	CRC "High"

5.4 Communication using Modbus RTU

Table 5- 27 Response for unsuccessful read operation - read request still not completed

Value	Byte	Description
11 h	0	Slave address
03 h	1	Function code (read)
20 h	2	Number of following data bytes (20 h: 32 bytes $\hat{=}$ 16 registers)
0001 h	3,4	40601: Check value 1 = request is processed
2F00 h	5,6	40602: Function 2F h(47), response length 0 (fault)
0004 h	7,8	40603: Error code: 0004 Response Not Ready (response has still not been issued)
xx h	9	CRC "Low"
xx h	10	CRC "High"

5.4.7.2 Write parameter

Example: Set p1121 = 12.15

Table 5- 28 Write parameter request: Writing the parameter value of p1121 from slave number 17

Value	Byte	Description
11 h	0	Slave address
10 h	1	Function code (write multiple)
0258 h	2,3	Register start address
000A h	4,5	Number of registers to be written to (40601 ... 40610)
14 h	6	Number of data bytes (10 registers, each 2 bytes = 20 bytes)
0001 h	7,8	40601: C1 (activate request)
2F10 h	9,10	40602: Function 2F h (47), request length 16 bytes (10 h)
8002 h	11,12	40603: Request reference = 80 h, request identifier = 2 h (write)
0101 h	13,14	40604: DO-Id = 1, number of parameters = 1
1001 h	15,16	40605: Attribute, number of elements = 1
0461 h	17,18	40606: Parameter number = 1121
0000 h	19,20	40607: Subindex = 0
0801 h	21,22	40608: Format + number of values
4142 h	23,24	40609: Parameter value 12,15
6666 h	25,26	40610: Parameter value
xx h	27	CRC "Low"
xx h	28	CRC "High"

Table 5- 29 Start parameter request: Writing the parameter value of p1121 from slave number 17

Value	Byte	Description
11 h	0	Slave address
06 h	1	Function code (write)
0258 h	2,3	Register start address
0007 h	4,5	Number of registers to be written to (40601 ... 40610)
0010 h	6,7	Number of registers
xx h	8	CRC "Low"
xx h	9	CRC "High"

Table 5- 30 Response for successful write operation

Value	Byte	Description
11 h	0	Slave address
06 h	1	Function code (write)
20 h	2	Number of following data bytes (20 h: 32 bytes \triangleq 16 registers)
0002 h	3,4	40601: DS47 Control = 2 (request was executed)
2F04 h	5,6	40602: Function code 2F h (47), response length 4 bytes
8002 h	7,8	40603: Request reference mirrored = 80 h, response identifier = 2 (change parameter)
0101 h	9,10	40604: DO-ID = 1, number of parameters = 1
xx h	11	CRC "Low"
xx h	12	CRC "High"

Table 5- 31 Response for unsuccessful write operation - write request still not completed

Value	Byte	Description
11 h	0	Slave address
06 h	1	Function code (write)
20 h	2	Number of following data bytes (20 h: 32 bytes \triangleq 16 registers)
0001 h	3,4	40601: DS47 Control = 1 (request is processed)
2F00 h	5,6	40602: Function 2F h(47), response length 0 (fault)
0004 h	7,8	40603: Error code: 0004 Response Not Ready (response has still not been issued)
xx h	9	CRC "Low"
xx h	10	CRC "High"

5.4.8 Communication procedure

Procedure for communication in a normal case

Normally, the master sends a telegram to a slave (address range 1 ... 247). The slave sends a response telegram to the master. This response telegram mirrors the function code; the slave enters its own address in the telegram and so the slave identifies itself with the master.

The slave only processes orders and telegrams which are directly addressed to it.

Communication error

If the slave detects a communication error on receipt (parity, CRC), it does not send a response to the master (this can lead to "setpoint timeout").

Logical error

If the slave detects a logical error within a request, it responds to the master with an "exception response". In this case, the slave sets the highest bit in the function code to 1 in the response. If, for example, it receives an unsupported function code from the master, the slave responds with an "exception response" with code 01 (illegal function code).

Table 5- 32 Overview of exception codes

Exception code	Modbus name	Remark
01	Illegal function code	An unknown (unsupported) function code was sent to the slave.
02	Illegal Data Address	An invalid address was requested.
03	Illegal data value	An invalid data value was detected.
04	Server failure	Slave has terminated during processing.

Maximum processing time, p2024[0]

The slave-response time is the time in which the Modbus master expects a response to a request. Set the same slave-response time (p2024 [0] in the inverter) in the master and slave.

Process data monitoring time (setpoint timeout), p2040

"Setpoint timeout" (F1910) is issued by the Modbus if p2040 is set to a value > 0 ms and no process data is requested within this time period.

The "Setpoint timeout" only applies for access to process data (40100, 40101, 40110, 40111). The "Setpoint timeout" is not generated for parameter data (40200 ... 40522).

Note

Adjust the time (factory setting = 100 ms) depending on the number of slaves and the baud rate set on the bus.

5.4.9 Application example

An application example for MODBUS RTU is provided on the Internet:



Communication via the MODBUS interface

(<https://support.industry.siemens.com/cs/ww/en/view/35928944>)

5.5 Communication via BACnet MS/TP - only CU230P-2 HVAC / BT

BACnet properties

In BACnet, components and systems are considered to be black boxes which contain a number of objects. BACnet objects only stipulate the behavior outside the device, BACnet sets no internal functions.

A range of object types and their instances represent one component.

Each BACnet device has precisely one BACnet device object. An NSAP (Network Service Access Point - comprising network number and MAC address; MAC: **Medium Access Control**) uniquely identifies a BACnet device. This address is BACnet-specific and must not be confused with the Ethernet MAC address.

Data exchange with the client

The inverter receives control commands and setpoints via service instructions from the control and transmits its status back to the control. The inverter can also send telegrams automatically itself, respectively execute services, e.g. COV_Notification.

Communication settings

- The Control Unit supports BACnet via RS485 (BACnet MS/TP),
- Communication supports Unicode, coded with the character set UTF-8
- The maximum cable length is 1200 m (3281 ft).

Protocol Implementation Conformance Statement



You will find the Protocol Implementation Conformance Statement (PICS) in the Internet under: PICS (http://www.big-eu.org/uploads/tx_teproddb/catalog_pdf/PICS_CU230P-2_HVAC_v47_SP3.docx)

Note

It is not permitted to change over the units

The "Unit switchover" function – for details see the operating instructions of the Control Unit – is not permissible with this bus system!

5.5.1 Basic settings for communication

Setting communication via BACnet

Procedure

1. Select the default setting 110
 - With Startdrive during commissioning step "Default setting of setpoint/command sources":
110 "BT Mac 10: BACnet MS/TP fieldbus"
 - With the BOP-2 during the basic commissioning under step "MAC PAr P15":
P_F bAc
 - Via parameter number:
p0015 = 110
2. Set the inverter address.
3. Make additional changes based on the parameters listed in the following sections.
4. If you are working with Startdrive, back up the settings so they are not lost if the power fails.

You have now made the settings for communication via BACnet.



Settings by "BT Mac 10: BACnet MS/TP fieldbus"

Fieldbus protocol selection p2030 = 5

Baud rate p2020 = 8, 38400 bit/s

Setting range: 9600 bit/s ... 76800 bit/s

Fieldbus monitoring time p2040 = 1000 ms

Setting range: 0 ms ... 1999999 ms

The more slaves that are connected in the network, the longer the fieldbus monitoring time must be.

If process data is not transferred within one cycle of the fieldbus monitoring time, then the inverter shuts down with fault F01910.

p2040 = 0 ⇒ bus monitoring deactivated.

5.5.1.1 Setting the address

Valid address area: 0 ... 127

With address 0, the inverter responds to a broadcast.

You have the following options for setting the BACnet address:

- Using the address switch on the Control Unit:

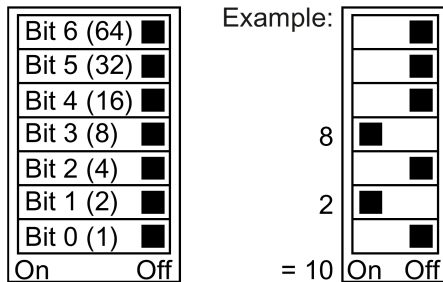



Figure 5-12 Address switch with example for bus address 10

The address switch has priority over the other settings.

- Using Startdrive or an operator panel via parameter p2021 (default setting: p2021 = 0). it is only possible to change p2021 if the address switch is set to 0.

If you are working with Startdrive, back up the settings so they are not lost if the power fails.

You can find the position of the address switch in the operating instructions for the inverter.

 Manuals and technical support (Page 232)

Activating the changed bus address

Procedure

1. Set the address as described above.
2. Switch off the inverter power supply.
3. Wait until all LEDs on the inverter are dark.
4. Switch on the inverter power supply again.

Your settings become effective after switching on.

You have now set the bus address.

□

5.5.1.2 Parameters for setting communication via BACnet

General settings

Processing times p2024[0 ... 2]

p2024[0]: 0 ms ... 10000 ms, maximum processing time (APDU timeout), factory setting = 6000 ms,
p2024 [1 ... 2]: Irrelevant

BACnet communication parameter p2025[0 ... 3]

- p2025 [0]: 0 ... 4194303: Device object instance number, Factory setting = 1
- p2025 [1]: 1 ... 10: Maximum Info Frames, factory setting = 5
- p2025 [2]: 0 ... 39: Number of APDU Retries (repeated attempts after fault telegrams), factory setting = 3
- p2025 [3]: 1 ... 127: maximum master address, factory setting = 32

Setting the COV_Increments p2026[0 ... 74]

(COV = change of values) 0 ... 4194303.000, factory setting = 1. A maximum of 32 COVs are permissible.

COV_Increment: Changes the value of the "present value" of an object instance for which the server transfers an UnConfirmedCOV_Notification or ConfirmedCOV_Notification.

You can use these parameters to set for which inverter value changes an UnConfirmedCOV_Notification or ConfirmedCOV_Notification result is sent.

The factory setting 1 means that the inverter sends an UnConfirmedCOV_Notification or ConfirmedCOV_Notification if the considered value, e.g. for a range of 0 ... 10 V, changes by an absolute value ≥ 1 .

This requires an active SubscribeCOV_Service to send the relevant object instance.

You can also set the COV_Increment via the object property "COV_Increment" of the relevant analog input, analog output or analog value.

BACnet language selection p2027

German/English - only becomes effective after power off/on

Fieldbus error statistics r2029

Displaying receive errors at the fieldbus interface

Device name - default setting, change name, restore factory setting

In BACnet, the Control Unit has a unique name, which is required for identification when replacing a device etc.

The device name is preset at initial power up. It has the following structure:

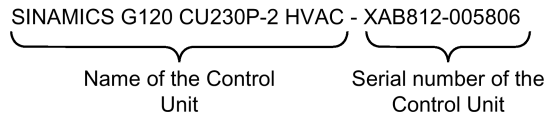

The name is represented in the ASCII format in the 79 indices of p7610.

Changing device names - procedure

1. To change, overwrite p7610 either directly in the inverter or write the name via the control using the "Object Write Property Object Device, Object Name".
2. If you are working with Startdrive, back up the settings so they are not lost if the power fails.
3. Switch off the inverter power supply to activate the name.
4. Wait until all LEDs on the inverter are dark.
5. Switch on the inverter power supply again.

Your settings become effective after switching on.

You have now changed the name.



When restoring the factory setting, the device name is not changed.

If you wish to reset the name to the original value, set p7610[0] = 0 and activate it as described above.

Interconnecting analog outputs

If you set communication via BACnet (p2030 = 5) then the analog outputs of the inverter are internally interconnected with the fieldbus analog outputs:

- p0771[0] = 791[0]
- p0771[1] = 791[1].

The values for p0791[0] and p0791[1] are written via objects ANALOG OUTPUT 0 and ANALOG OUTPUT 1. Interconnections between parameter p0791 and other sources are rejected.

This means that the control outputs system-specific values via the analog outputs of the inverter.

However, if you still wish to display an inverter-specific value, then you must adapt the appropriate wiring.

Example

- AO 0 should display the value written with object ANALOG OUTPUT 0 via the control. In this particular case, no other settings are required in the inverter.
- AO 1 should display the smoothed current actual value. To do this, you must set p0771[1] = 27 (r0027 smoothed current actual value).
In this case, a write access via the object ANALOG OUTPUT 1 to p0971[1] results in a fault message in the control

Note**Reset to the factory setting for BACnet**

If you set communication via BACnet (p2030 = 5), when restoring the factory settings, the analog outputs are again interconnected with p0771[0] = 791[0] and p0771[1] = 791[1].

5.5.2 Supported services and objects**BIBBs used by the inverter**

The BIBBs (BIBB: **B**ACnet **I**nteroperability **B**uilding **B**lock) are a collection of one or several BACnet services. BACnet services are subdivided into A and B devices. An A device operates as client and a B device as server.

The inverter is a server and therefore operates as B device, as "BACnet Application Specific Controller" (B-ASC).

It uses the following executed BIBBs.

Overview of the BIBB used and the associated services

Short designation	BIBB	Service
DS-RP-B	Data Sharing-ReadProperty-B	ReadProperty
DS-RPM-B	Data Sharing-ReadMultipleProperty-B	ReadPropertyMultiple
DS-WP-B	Data Sharing-WriteProperty-B	WriteProperty
DM-DDB-B	Device Management-Dynamic Device Binding-B	<ul style="list-style-type: none"> • Who-Is • I-Am
DM-DOB-B	Device Management-Dynamic Object Binding-B	<ul style="list-style-type: none"> • Who-Has • I-Have
DM-DCC-B	Device Management-DeviceCommunicationControl-B	DeviceCommunicationControl
DS-COV-B	Data Sharing-COV-B	<ul style="list-style-type: none"> • SubscribeCOV, • ConfirmedCOVNotification, • UnConfirmedCOVNotification

The inverter can simultaneously process up to 32 SubscribeCOV services. These can all refer to the same object instances - or different object instances.

SubscribeCOV monitors the property changes of the following objects:

- Analog Input (Alxx),
- Analog Output (AOxx),
- Analog Value (AVxx),
- Binary Value (BVxx) and
- Multi-state Input (MSlxx)

Note

SubscribeCOV services are not retentive; i.e., when restarting the CU the master must reinitiate SubscribeCOV services.

Code numbers of the object types supported in BACnet

Object type	Code number for BACnet object type	Object type	Code number for BACnet object type
Device Object	8	Analog Output Object	1
Binary Input Object	3	Analog Value Object	2
Binary Output Object	4	Multi-State Input Object	13
Binary Value Object	5	Octet String Values	47
Analog Input Object	0		

Object properties of the "Device" object type

• Object_Identifier	• Application_Software_Version	• APDU_Timeout
• Object_Name	• Protocol_Version	• Number_Of_APDU_Retries
• Object_Type	• Protocol_Revision	• Max Master
• System_Status	• Protocol_Services_Supported	• Max Info Frames
• Vendor_Name	• Protocol_Object_Types_Supported	• Device Address Binding
• Vendor_Identifier	• Object_List	• Database Revision
• Model_Name	• Max_APDU_Length_Accepted ¹⁾	
• Firmware_Revision	• Segmentation_Supported ²⁾	

¹⁾ Length = 480, ²⁾ not supported

Object properties of other object types

Object property	Object type							
	Binary Input	Binary Output	Binary Value	Analog Input	Analog Output	Analog Value	Multi-State Input	Octet String Values
Object_Identifier	X	X	X	X	X	X	X	X
Object_Name	X	X	X	X	X	X	X	X
Object_Type	X	X	X	X	X	X	X	X
Present_Value	X	X	X	X	X	X	X	X
Description	X	X	X	X	X	X	X	
Status_Flags	X	X	X	X	X	X	X	X
Event_State	X	X	X	X	X	X	X	
Out_Of_Service	X	X	X	X	X	X	X	
Units				X	X	X		
Priority_Array		X	X*		X	X*		
Relinquish_Default		X	X*		X	X*		
Polarity	X	X						
Active_Text	X	X	X					
Inactive_Text	X	X	X					
COV_Increment				X	X	X		
State_Text							X	
Number_of_States							X	

* for command values only (access type C)

Note

Access types are available in the following versions

- C: Executable
 - R: Readable
 - W: Writable
-

Binary Input Objects

Instance ID	Object name	Description	Possible values	Text active / text inactive	Access type	Parameter
BI0	DI0 ACT	State of DI 0	ON/OFF	ON/OFF	R	r0722.0
BI1	DI1 ACT	State of DI 1	ON/OFF	ON/OFF	R	r0722.1
BI2	DI2 ACT	State of DI 2	ON/OFF	ON/OFF	R	r0722.2
BI3	DI3 ACT	State of DI 3	ON/OFF	ON/OFF	R	r0722.3
BI4	DI4 ACT	State of DI 4	ON/OFF	ON/OFF	R	r0722.4
BI5	DI5 ACT	State of DI 5	ON/OFF	ON/OFF	R	r0722.5
BI7	DI7 ACT	State of AI 1 - used as DI	ON/OFF	ON/OFF	R	r0722.11
BI8	DI8 ACT	State of AI 2 - used as DI	ON/OFF	ON/OFF	R	r0722.12
BI10	DO0 ACT	State of DO 0 (relay 1)	ON/OFF	ON/OFF	R	read r747.0
BI11	DO1 ACT	State of DO 1 (relay 2)	ON/OFF	ON/OFF	R	read r747.1
BI12	DO2 ACT	State of DO2 (relay 3)	ON/OFF	ON/OFF	R	read r747.2

Binary Output Objects

Instance ID	Object name	Description	Possible values	Text active / text inactive	Access type	Parameter
BO0	DO0 CMD	Controls DO 0 (relay 1)	ON/OFF	ON/OFF	C	p0730
BO1	DO1 CMD	Controls DO 1 (relay 2)	ON/OFF	ON/OFF	C	p0731
BO2	DO2 CMD	Controls DO 2 (relay 3)	ON/OFF	ON/OFF	C	p0732

Binary value Objects

Instance ID	Object name	Description	Possible values	Text active	Text inactive	Access type	Parameter
BV0	RUN / STOP ACT	Inverter status regardless of command source	RUN / STOP	STOP	RUN	R	r0052.2
BV1	FWD / REV	Direction of rotation regardless of command source	REV / FWD	FWD	REV	R	r0052.14
BV2	FAULT ACT	Inverter fault	FAULT / OK	FAULT	OK	R	r0052.3
BV3	WARN ACT	Inverter warning	WARN / OK	WARN	OK	R	r0052.7
BV4	MANUAL / AUTO ACT	Indicates the source of the manual/auto inverter control	AUTO / MANUAL	AUTO	LOCAL	R	r0052.9
BV7	CTL OVERRIDE ACT	ACT displays the inverter's control unit from the BACnet override control unit via BV93. Note that the operator panel's "Manual" operating mode has a higher priority than the BACnet override control.	ON/OFF	0	1	R	r2032[10]

5.5 Communication via BACnet MS/TP - only CU230P-2 HVAC / BT

Instance ID	Object name	Description	Possible values	Text active	Text inactive	Access type	Parameter
BV8	AT SET-POINT	Setpoint reached	YES / NO	YES	NO	R	r0052.8
BV9	AT MAX FREQ	Maximum speed reached	YES / NO	YES	NO	R	r0052.10
BV10	DRIVE READY	Inverter ready	YES / NO	YES	NO	R	r0052.1
BV15	RUN COM ACT	ACT indicates the status of the ON command, regardless of the source	YES / NO	0	1	R	r2032[0]
BV16	HIB MOD ACT	ACT means that the inverter is operating in energy-saving mode.	ON/OFF	0	1	R	r2399[1]
BV17	ESM MOD	ACT means that the inverter is operating in the essential service mode	ON/OFF	0	1	R	r3889[0]
BV20	RUN / STOP CMD	ON command for the inverter (when controlling via BACnet)	RUN / STOP	0	1	C	r0054.0
BV21	FWD / REV CMD	Reverse direction of rotation (when controlling via BACnet)	REV / FWD	0	1	C	r0054.11
BV22	FAULT RESET	Acknowledge fault (when controlling via BACnet)	RESET / NO	0	1	C	r0054.7
BV24	CDS	Local / Remote	Local / Remote	YES	NO	C	r0054.15
BV26	RUN ENA CMD	Enable inverter operation		ENABLED	DISABLED	C	r0054.3
BV27	OFF2	OFF2 status	RUN / STOP	0	1	C	r0054.1
BV28	OFF3	OFF3 status Note: BV28 sets the r0054.4, r0054.5, and r0054.6 bits	RUN / STOP	0	1	C	r0054.2
BV50	ENABLE PID	Enable technology controller	ENABLED / DISABLED	ENABLED	DISABLED	C	p2200
BV51	ENABLE PID 0	Enable technology 0 controller	ENABLED / DISABLED	ENABLED	DISABLED	C	p11000
BV52	ENABLE PID 1	Enable technology 1 controller	ENABLED / DISABLED	ENABLED	DISABLED	C	p11100
BV53	ENABLE PID 2	Enable technology 2 controller	ENABLED / DISABLED	ENABLED	DISABLED	C	p11200
BV90	LOCAL LOCK	Use MANUAL (operator panel) to lock inverter control		LOCK	UNLOCK	C	p0806
BV93	CTL OVERRIDE CMD	Inverter control using BACnet override control	ON/OFF	0	1	C	r0054.10

Analog Input Objects

Instance ID	Object name	Description	Unit	Range	Access type	Parameter
AI0	ANALOG IN 0	AI0 input signal	V/mA	inverter-dependent	R	r0752[0]
AI1	ANALOG IN 1	AI1 input signal	V/mA	inverter-dependent	R	r0752[1]
AI2	ANALOG IN 2	AI2 input signal	V/mA	inverter-dependent	R	r0752[2]
AI3	ANALOG IN 3	AI3 input signal	V/mA	inverter-dependent	R	r0752[3]
AI10	AI 0 SCALED	Scaled AI 0 input signal	%	inverter-dependent	R	r0755[0]
AI11	AIN 1 SCALED	Scaled AI 1 input signal	%	inverter-dependent	R	r0755[1]
AI12	AIN 2 SCALED	Scaled AI 2 input signal	%	inverter-dependent	R	r0755[2]
AI13	AIN 3 SCALED	Scaled AI 3 input signal	%	inverter-dependent	R	r0755[3]

Analog Output Objects

Instance ID	Object name	Description	Unit	Range	Access type	Parameter
AO0	ANALOG OUTPUT 0	Value of AO0	%	inverter-dependent	C	p0791.0
AO1	ANALOG OUTPUT 1	Value of AO1	%	inverter-dependent	C	p0791.1

Analog Value Objects

Instance ID	Object name	Description	Unit	Range	Access type	Parameter
AV0	OUT FREQ HZ	Output frequency (Hz)	Hz	inverter-dependent	R	r0024
AV1	OUT FREQ PCT	Output frequency (%)	%	inverter-dependent	R	HIW
AV2	OUTPUT SPEED	Motor speed	RPM	inverter-dependent	R	r0022
AV3	DC BUS VOLT	DC-link voltage.	V	inverter-dependent	R	r0026
AV4	OUTPUT VOLT	Output voltage	V	inverter-dependent	R	r0025
AV5	CURRENT	Motor current	A	inverter-dependent	R	r0027
AV6	TORQUE	Motor torque	Nm	inverter-dependent	R	r0031
AV7	POWER	Motor power	kW	inverter-dependent	R	r0032
AV8	DRIVE TEMP	Heat sink temperature	°C	inverter-dependent	R	r0037
AV9	MOTOR TEMP	Measured or calculated motor temperature	°C	inverter-dependent	R	r0035
AV10	KWH NR	Cumulative inverter energy consumption (cannot be reset!)	kWh	inverter-dependent	R	r0039
AV12	INV RUN TIME	Motor's operating hours (is reset by entering "0")	h	0 ... 4294967295	W	p0650
AV13	INV Model	Code number of Power Module	---	inverter-dependent	R	r0200
AV14	INV FW VER	Firmware version	---	inverter-dependent	R	r0018
AV15	INV POWER	Rated power of the inverter	kW	inverter-dependent	R	r0206
AV16	SPEED STPT 1	Reference speed of the inverter	RPM	6.0 ... 210000	W	p2000

5.5 Communication via BACnet MS/TP - only CU230P-2 HVAC / BT

Instance ID	Object name	Description	Unit	Range	Access type	Parameter
AV17	FREQ SP PCT	Setpoint 1 (when controlling via BACnet)	%	-199.99 ... 199.99	C	HSW
AV18	ACT FAULT	Number of the fault due to be dealt with	---	inverter-dependent	R	r0947[0]
AV19	PREV FAULT 1	Number of the last fault	---	inverter-dependent	R	r0947[1]
AV20	PREV FAULT 2	Number of the fault before last	---	inverter-dependent	R	r0947[2]
AV21	PREV FAULT 3	Number of the fault third from last	---	inverter-dependent	R	r0947[3]
AV22	PREV FAULT 4	Number of the fault fourth from last	---	inverter-dependent	R	r0947[4]
AV25	SEL STPT	Command to select the setpoint source	---	0 ... 32767	W	p1000
AV28	AO1 ACT	Signal from AO 1	mA	inverter-dependent	R	r0774.0
AV29	AO2 ACT	Signal from AO 1	mA	inverter-dependent	R	r0774.1
AV30	MIN Speed	Minimum speed	RPM	0.000 – 19500,000	W	p1080
AV31	MAX Speed	Maximum speed	RPM	0.000 ... 210000.00 0	W	p1082
AV32	ACCEL TIME	Ramp-up time	s	0.00 ... 999999.0	W	p1120
AV33	DECEL TIME	Ramp-down time	s	0.00 ... 999999.0	W	p1121
AV34	CUR LIM	Current limit	A	inverter-dependent	R	p0640
AV39	ACT WARN	Indication of a pending alarm	---	inverter-dependent	R	r2110[0]
AV40	PREV WARN 1	Indication of the last alarm	---	inverter-dependent	R	r2110[1]
AV41	PREV WARN 2	Indication of the last but one alarm	---	inverter-dependent	R	r2110[2]
AV5000	RAMP UP TIME	Technology controller ramp-up time	s	0 ... 650	W	p2257
AV5001	RAMP DOWN TIME	Technology controller ramp-down time	s	0 ... 650	W	p2258
AV5002	FILTER TIME	Technology controller actual value filter time constant	s	0 ... 60	W	p2265
AV5003	DIFF TIME	Technology controller differentiation time constant	s	0 ... 60	W	p2274
AV5004	PROP GAIN	Technology controller proportional gain	s	0 ... 1000	W	p2280
AV5005	INTEG TIME	Technology controller integral time	s	0 ... 1000	W	p2285
AV5006	OUTPUT MAX	Technology controller maximum limiting	%	- 200 ... 200	W	p2291
AV5007	OUTPUT MIN	Technology controller minimum limiting	%	- 200 ... 200	W	p2292
AV5100	RAMP UP TIME 0	Technology controller 0 ramp-up time	s	0 ... 650	W	p11057
AV5101	RAMP DOWN TIME 0	Technology controller 0 ramp-down time	s	0 ... 650	W	p11058
AV5102	FILTER TIME 0	Technology controller 0 actual value filter time constant	s	0 ... 60	W	p11065

Instance ID	Object name	Description	Unit	Range	Access type	Parameter
AV5103	DIFF TIME 0	Technology controller 0 differentiation time constant	s	0 ... 60	W	p11074
AV5104	PROP GAIN 0	Technology controller 0 proportional gain	s	0 ... 1000	W	p11080
AV5105	INTEG TIME 0	Technology controller 0 integral time	s	0 ... 1000	W	p11085
AV5106	OUTPUT MAX 0	Technology controller 0 maximum limiting	%	- 200 ... 200	W	p11091
AV5107	OUTPUT MIN 0	Technology controller 0 minimum limiting	%	- 200 ... 200	W	p11092
AV5200	RAMP UP TIME 1	Technology controller 1 ramp-up time	s	0 ... 650	W	p11157
AV5201	RAMP DOWN TIME 1	Technology controller 1 ramp-down time	s	0 ... 650	W	p11158
AV5202	FILTER TIME 1	Technology controller 1 actual value filter time constant	s	0 ... 60	W	p11165
AV5203	DIFF TIME 1	Technology controller 1 differentiation time constant	s	0 ... 60	W	p11174
AV5204	PROP GAIN 1	Technology controller 1 proportional gain	s	0 ... 1000	W	p11180
AV5205	INTEG TIME 1	Technology controller integral time	s	0 ... 1000	W	p11185
AV5206	OUTPUT MAX 1	Technology controller 1 maximum limiting	%	- 200 ... 200	W	p11191
AV5207	OUTPUT MIN 1	Technology controller 1 minimum limiting	%	- 200 ... 200	W	p11192
AV5300	RAMP UP TIME 2	Technology controller 2 ramp-up time	s	0 ... 650	W	p11257
AV5301	RAMP DOWN TIME 2	Technology controller 2 ramp-down time	s	0 ... 650	W	p11258
AV5302	FILTER TIME 2	Technology controller 2 actual value filter time constant	s	0 ... 60	W	p11265
AV5303	DIFF TIME 2	Technology controller 2 differentiation time constants	s	0 ... 60	W	p11274
AV5304	PROP GAIN 2	Technology controller 2 proportional gain	s	0 ... 1000	W	p11280
AV5305	INTEG TIME 2	Technology controller 2 integral time	s	0 ... 1000	W	p11285
AV5306	OUTPUT MAX 2	Technology controller 2 maximum limiting	%	- 200 ... 200	W	p11291
AV5307	OUTPUT MIN 2	Technology controller 2 minimum limiting	%	- 200 ... 200	W	p11292

Multi-State Input Objects

Instance ID	Object name	Description	Possible values	Access type	Parameter
MSI0	FAULT_1	Fault number 1	See List Manual "List of faults and alarms"	R	r0947[0]
MSI1	FAULT_2	Fault number 2		R	r0947[1]
MSI2	FAULT_3	Fault number 3		R	r0947[2]
MSI3	FAULT_4	Fault number 4		R	r0947[3]
MSI4	FAULT_5	Fault number 5		R	r0947[4]
MSI5	FAULT_6	Fault number 6		R	r0947[5]
MSI6	FAULT_7	Fault number 7		R	r0947[6]
MSI7	FAULT_8	Fault number 8		R	r0947[7]
MSI8	WARNING_1	Warning number 1		R	r2110[0]
MSI9	WARNING_2	Warning number 2		R	r2110[1]
MSI10	WARNING_3	Warning number 3		R	r2110[2]
MSI11	WARNING_4	Warning number 4		R	r2110[3]
MSI12	WARNING_5	Warning number 5		R	r2110[4]
MSI13	WARNING_6	Warning number 6		R	r2110[5]
MSI14	WARNING_7	Warning number 7		R	r2110[6]
MSI15	WARNING_8	Warning number 8	R	r2110[7]	

5.5.3 Acyclic communication (general parameter access) via BACnet

Acyclic communication or general parameter access is realized via BACnet objects DS47IN and DS47OUT.

Acyclic communication uses the octet string value objects OSV0 and OSV1.

Instance ID	Object name	Description	Access type
OSV0	DS47IN	Maximum length 242, of which two bytes header, 240 bytes user data	W
OSV1	DS47OUT		R

The OSV are structured as follows:

Function Code	Request length	User data
2F (1 Byte)	(1 byte)	Maximum 240 bytes

Write parameter request with OSV0 and read with OSV1

To read parameter r0002 write the following values into the present value window of OSV0

Table 5- 33 Write parameter request via OSV0

	Byte	Description
2F h	1	Function code 2F h (47),
0A h	2	Request length 10 bytes (0A h)
80 h	3	Request reference = 80 h
01 h	4	Request identifier = 1 h
01 h	5	DO-Id = 1
01 h	6	Number of parameters = 1
10 h	7	Attribute
01 h	8	Number of elements = 1
0002 h	9,10	Parameter number = 2
0000 h	11,12	Subindex = 0

If the request was successfully processed, then you can read out the response precisely once from the present value window of the OSV1:

Table 5- 34 Read parameter content via OSV1

	Byte	Description
2F h	1	Function code 2F h (47)
08 h	2	Response length 8 bytes
80 h	3	Request reference = 80 h
01 h	4	Request identifier = 1 h
01 h	5	DO-Id = 1
01 h	6	Number of parameters = 1
10 h	7	Format
01 h	8	Number of elements = 1
001F h	9,10	Parameter value 1F h = 31

If the response is still not available, then you receive the following message via the present value window of the OSV1:

Table 5- 35 Read parameter content via OSV1

	Byte	Description
2F h	1	Function code 2F h (47)
00 h	2	Response length 0 (error)
0004 h	3,4	Error code 4 h (response still not available)

If you wish to read the response once more, then you obtain the following message via the present value window of the OSV1:

Table 5- 36 Read parameter content again via OSV1

	Byte	Description
2F h	1	Function code 2F h (47)
00 h	2	response length 0 (error)
0002 h	3,4	Error code 2 h (Invalid State)

Overview of the error codes

- 1 h: Invalid Length (invalid length)
- 2 h: Invalid State (action is not permitted in the actual inverter state)
- 3 h: Invalid function Code (FC = 2 hex)
- 4 h: Response not ready (the response has still not been issued)
- 5 h: Internal Error (general system error)

Incorrect access operations to parameters via data set 47 are logged in objects OSV0 and OSV1.

5.6 Communication via P1 - only CU230P-2 HVAC, CU230P-2 BT

P1 is an asynchronous master-slave communication between what is known as a Field Cabinet (master) and the FLN devices (slaves). FLN stands for "Floor level network".

The master individually addresses the various slaves. A slave responds only if the master addresses it. Communication between the slaves is not possible.

A Field Cabinet can have several FLN ports. You can connect up to 32 FLN devices to each FLN port (slaves).

Settings in the controller

In the Field Cabinet, for each slave you must install what is known as a "Logical controller (LCTR) point". In addition, in the Field Cabinet you must define the "Point numbers" for communication.

An overview of the "Point Numbers" is provided on the following pages.

5.6.1 Basic settings for communication via P1

Overview

Procedure

Proceed as follows to set communication via P1:

1. Select the default setting 114
 - With Startdrive during commissioning step "Default setting of setpoint/command sources":
114 "BT Mac 14: Communication P1"
 - With the BOP-2 during basic commissioning under step "MAc PAr P15":
P_F_P1
 - Via parameter number:
p0015 = 114

After selecting default setting 114, the inverter automatically sets the following parameters:

- p2030 = 8: Fieldbus protocol P1
 - p2020 = 5: Baud rate 4800 bit/s
 - p0840 = 2090.0 The ON/OFF1 command is interconnected with control word 1, bit 0
 - p0852 = 2090.3: The signal for "Enable operation" is interconnected with control word 1, bit 3
 - p2103[0] = 2090.7: The signal for "Acknowledge fault" is interconnected with control word 1, bit 7
2. Set the address.
Irrespective of the address that has been set, every FLN device responds to telegrams with address 99.
 3. Make additional changes based on the parameters listed in the following sections.
 4. If you are working with Startdrive, back up the settings so they are not lost if the power fails.

You have now set the communication via P1.



Additional parameters for adapting communication via P1

- p2020 = 7: Baud rate 19200 bit/s
- p1070 = 2050[1]: Receive main setpoint via fieldbus
- p2051[0] = 52: Send status word via fieldbus
- p2051[1] = 63: Send speed actual value via fieldbus

5.6.2 Setting the address

Valid address area: 1 ... 99

You have the following options for setting the address:

- Using the address switch on the Control Unit:

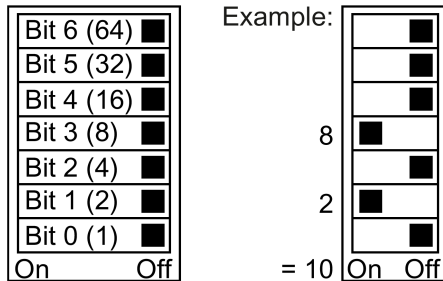

Figure 5-13 Address switch with example for bus address 10

The address switch has priority over the other settings.

- Using Startdrive or an operator panel via parameter p2021 (default setting: p2021 = 99). It is only possible to change p2021 if an invalid address is set in the address switch.

If you are working with Startdrive, back up the settings so they are not lost if the power fails.

You can find the position of the address switch in the operating instructions for the inverter.

 Manuals and technical support (Page 232)

Activating the changed bus address

Procedure

1. Set the address as described above.
2. Switch off the inverter power supply.
3. Wait until all LEDs on the inverter are dark.
4. Switch on the inverter power supply again.

Your settings become effective after switching on.

You have now set the bus address.

□

5.6.3 Point numbers

The subsequently listed "Point Numbers" for communication are defined using P1 in the converter. The values listed in the tables refer to SI units.

Point No.	Descriptor	Default/factory	Units	Slope	Intercept	Subpt. Type	IO Type	On Text		CU Param / Word Type
								Off Text	Range	
1	CTLR ADDRESS	99	--	1	0	2	LAO_255	0 ... 255		p2021
2	APPLICATION	2767	--	1	0	2	LAO_32k	0 ... 32767		p8998[0]
3	FREQ OUTPUT	0	HZ	0.04	-650	1*)	LAI_32k	-650 ... 650		r0024
5	SPEED	0	RPM	1	-16250	1*)	LAI_32k	-16250 ... 16250		r0022
6	CURRENT	0	A	0.05	0	1*)	LAI_32k	0 ... 1638.4		r0027
7	TORQUE	0	NM	0.2	-3250	1*)	LAI_32k	-3250 ... 3250		r0031
8	ACTUAL PWR	0	KW	0.01	0	1	LAI_32k	0 ... 327.67		r0032
9	TOTAL KWH	0	KWH	1	0	1	LAI_32k	0 ... 32767		r0039
13	DC BUS VOLTS	0	V	1	0		LAI_32k	0 ... 32767		r0026
14	REFERENCE	0	HZ	0.04	-650		LAI_32k	-650 ... 650		r0020
16	RATED PWR	0	KW	0.01	0		LAI_32k	0 ... 327.67		r0206
17	OUTPUT VOLTS	0	V	1	0		LAI_32k	0 ... 32767		r0025
20	OVRD TIME	1	HRS	1	0	2	LAO_255	0 ... 255		p8998[1]
21	AR MAX FREQ	0	--	1	0	1	LDI	MAX	NO	ZSW:10
22	CMD FWD REV	0	--	1	0	1	LDO	REV	FWD	STW:11
23	FWD REV	0	--	1	0	1	LDI	FWD	REV	ZSW:14
24	CMD START	0	--	1	0	1	LDO	START	STOP	STW:0
25	STOP RUN	0	--	1	0	1	LDI	RUN	STOP	ZSW:2
26	CONTROL MODE	1	--	1	0	1	LDI	SERIAL	LOCAL	ZSW:9
28	READY TO RUN	0	--	1	0	1	LDI	READY	OFF	ZSW:1
29	DAY NIGHT	0	--	1	0	1	LDO	NIGHT	DAY	p8998[2]
30	CURRENT LMT	0.0	PCT	0.1	10.0	2	LAO_4k	0 ... 400		p0640
31	ACCEL TIME 1	10.00	SEC	0.02	0	2	LAO_32k	0 ... 650.00		p1120
32	DECEL TIME 1	10.00	SEC	0.02	0	2	LAO_32k	0 ... 650.00		p1121
34	HAND AUTO	0	--	1	0	2	LDI	HAND	AUTO	r0807.0

Point No.	Descriptor	Default/factory	Units	Slope	Intercept	Subt. Type	IO Type	On Text		Off Text	CU Param / Word Type
								ENABLE	Range		
35	RUN ENABLE	1	--	1	0	1	LDO	ENABLE	OFF	OFF	STW:3
36	ENABLED	0	--	1	0	1	LDI	ON	OFF	OFF	ZSW:0
40	DIGITAL OUT 1	0	--		0	2	LDO	ON	OFF	OFF	p0730 / r747.0
41	DIGITAL OUT 2	0	--	1	0	2	LDO	ON	OFF	OFF	p0731 / r747.1
42	DIGITAL OUT 3	0	--	1	0	2	LDO	ON	OFF	OFF	p0732 / r747.2
45	ANALOG IN 1	0	PCT	0.1	-300.0	1*	LAI_32k		-300 ... 300		r0755[0]
46	ANALOG IN 2	0	PCT	0.1	-300.0	1*	LAI_32k		-300 ... 300		r0755[1]
47	ANALOG OUT 1	0	PCT	0.1	-100.0	1	LAI_32k		-100 ... 100		r0774[0]
48	ANALOG OUT 2	0	PCT	0.1	-100.0	1	LAI_32k		-100 ... 100		r0774[1]
51	FREQ REF	0	PCT	0.006103515	0	1*	LAO_32k		0 ... 100		HSW
52	FREQ ACTUAL	0	PCT	0.012207031	-100.0	1*	LAI_32k		-100.0 ... 100.0		HIW
53	FREQ MAX	3000.00	HZ	0.02	1.00	1	LAO_32k		0.10 ... 650.00		p2000 1/min à Hz
55	PID SP REF	0	PCT	0.024414063	-200.0	1	LAO_32k		-200.0 ... 200.0		p2240
56	PID SP OUT	0	PCT	0.012207031	-100.0	1	LAI_32k		-100.0 ... 100.0		r2250
57	PID UP LMT	100.0	PCT	0.024414063	-200.0	1	LAO_32k		-200.0 ... 200.0		p2291
58	PID LO LMT	0	PCT	0.024414063	-200.0	1	LAO_32k		-200.0 ... 200.0		p2292
59	PID OUTPUT	0	PCT	0.012207031	0	1	LAI_32k		-100.0 ... 100.0		r2294
60	PI FEEDBACK	0	PCT	0.012207031	-100.0	1*	LAI_32k		-100.0 ... 100.0		r2266
61	P GAIN	1.000	--	0.01	0	2	LAO_32k		0 ... 100.00		p2280
62	I GAIN	0	SEC	0.002	0	2	LAO_32k		0 ... 60.00		p2285
63	D GAIN	0	--	0.002	0	2	LAO_32k		0 ... 60.00		p2274
64	ENABLE PID	0	--	1	0	2	LDO	ON	OFF	OFF	p2200
66	FEEDBK GAIN	100.0	PCT	0.02	0	2	LAO_32k		0 ... 500.00		p2269
68	LOW PASS	0	--	0.01	0	2	LAO_32k		0 ... 60.00		p2265
71	DIGITAL IN 0	0	--	1	0	1	LDI	ON	OFF	OFF	r0722.0

5.6 Communication via P1 - only CU230P-2 HVAC, CU230P-2 BT

Point No.	Descriptor	Default/factory	Units	Slope	Intercept	Subpt. Type	IO Type	On Text		Off Text	CU Param / Word Type
								Range	Range		
72	DIGITAL IN 1	0	--	1	0	1	LDI	ON	OFF	OFF	r722.1
73	DIGITAL IN 2	0	--	1	0	1	LDI	ON	OFF	OFF	r722.2
74	DIGITAL IN 3	0	--	1	0	1	LDI	ON	OFF	OFF	r722.3
75	DIGITAL IN 4	0	--	1	0	1	LDI	ON	OFF	OFF	r722.4
76	DIGITAL IN 5	0	--	1	0	1	LDI	ON	OFF	OFF	r722.5
80	WDOG TIME	100	ms	10	0	2	LAO_8k	0 ... 65530			p2040
83	INVERTER VER	Apr 50	--	0.01	0	2	LAI_32k	00.00 ... 99.99			r0018
84	DRIVE MODEL	0	--	1	0	2	LAI_32k	0 ... 32767			r0200
90	ACTIVE FAULT	0	--	1	0	1*)	LAI_32k	0 ... 32767			r0947[0]
91	1st FAULT	0	--	1	0	1*)	LAI_32k	0 ... 32767			r0947[1]
92	2nd FAULT	0	--	1	0	1*)	LAI_32k	0 ... 32767			r0947[2]
93	3rd FAULT	0	--	1	0	1*)	LAI_32k	0 ... 32767			r0947[3]
94	FAULT	0	--	1	0	1	LDI	FAULT	OK	OK	ZSW:3
95	FAULT ACK	0	--	1	0	1	LDO	ON	OFF	OFF	STW:7
96	WARNING	0	--	1	0	1	LDI	WARN	OK	OK	ZSW:7
97	ACTIVE WARNING	0	--	1	0	1*)	LAI_32k	0 ... 32767			r2110[0]
98	RAM TO ROM	0	--	1	0	1	LDO	SAVE	DONE	DONE	p971/p10=30
99	ERROR STATUS	0	--	1	0	1*)	LAI_255	0 ... 255			r947[0]

1*): For reasons of compatibility, these type 1 subpoints can save COV area information. Point Number 98 RAM TO ROM was implemented in order to be able to save these in a non-volatile fashion.

Communication over CANopen

General information on CAN



You can find general information about CAN in the Internet:
CAN Internet pages (<http://www.can-cia.org>)

The CAN dictionary provides an explanation of the CAN terminology:
CAN downloads (<http://www.can-cia.org/index.php?id=6>).

Integrating an inverter in a CANopen network

To integrate an inverter in a CANopen network, we recommend the EDS file on the Internet
EDS (<http://support.automation.siemens.com/WW/view/en/48351511>).

This file is the description file of the SINAMICS G120 inverter for CANopen networks. In this way, you can use the objects of the DSP 402 device profile.

The following Control Units and inverters have an CANopen interface



G120 CU230P-2 CAN
G120 CU250S-2 CAN



G120C CAN

Table 6- 1 Pin assignment of the connector

Signal	D sub connector X126 1 ... 5  6 ... 9
---	1
CAN_L, CAN signal (dominant low)	2
CAN_GND, CAN ground	3
---	4
(CAN_SHLD), optional shield	5
(CAN_GND), optional ground	6
CAN_H, CAN signal (dominant high)	7
---	8
---	9

Grounding the CANopen Control Unit

The CAN ground (pin 3) and the optional ground are electrically isolated from the ground potential of the system.

The optional shield (pin 5) and the connector housing are connected with the ground potential of the system.

CANopen functions of the inverter



CANopen is a communication protocol with line-type topology that operates on the basis of communication objects (COB).

SINAMICS G120 inverters with CANopen interface comply with the following standards:

- CiA 301 (Application Layer and Communication Profile)
- CiA 303-3 (Indicator Specification)
- CiA 306 (Electronic Data Sheet Specification for CANopen)
- CiA 402 (Device Profile for Drives and Motion Control)

Communication objects (COB)

The inverter operates with the following communication objects:

-  **NMT** Network management (NMT service) (Page 172)
Network management objects for controlling CANopen communication and for monitoring the individual nodes on the basis of a master-slave relationship.
-  **SDO** SDO services (Page 175)
Service data objects for reading and changing parameters
-  **PDO** PDO services (Page 179)
Process data objects to transfer process data, TPDO to transmit, RPDO to receive process data
- **SYNC**
Synchronization objects
- **EMCY**
Time stamp and fault messages

COB ID

A communication object contains the data to be transferred and a unique 11-bit COB ID. The COB ID also defines the priority for processing the communication objects. The communication object with the lowest COB ID always has the highest priority.

COB ID for individual communication objects

You will find the specifications for the COB IDs of the individual communication objects below:

- **COB ID_{NMT} = 0** Cannot be changed
- **COB ID_{SYNC} = free** Pre-assigned with 80 hex
- **COB ID_{EMCY} = free** 80 hex + NAlleode-ID = COB ID_{EMCY}
- **COB ID_{TPDO} = free** In the free PDO mapping *)
- **COB ID_{RPDO} = free** In the free PDO mapping *)
- **COB ID_{TSDO} = 580 hex + node ID**
- **COB-ID_{RSDO} = 600 hex + node ID**
- **COB ID_{Node Guarding/Heartbeat} = 700 hex + node ID**

*)  Predefined connection set (Page 182)

6.1 Network management (NMT service)

Network management (NMT) is node-oriented and has a master-slave topology.

A node is a master or a slave.

The inverter is an NMT slave, and can adopt the following states:

- Boot-up service COB-ID = 700 hex + Node-ID
- Node Control Service COB ID = 0 (see CANopen state diagram)

The transition between two states is realized using NMT services. Details on NMT services:



CiA 301 (Application Layer and Communication Profile) (<http://www.can-cia.org/index.php?id=specifications>).

- Error Control Service COB-ID = 700 hex + Node-ID

CANopen state diagram

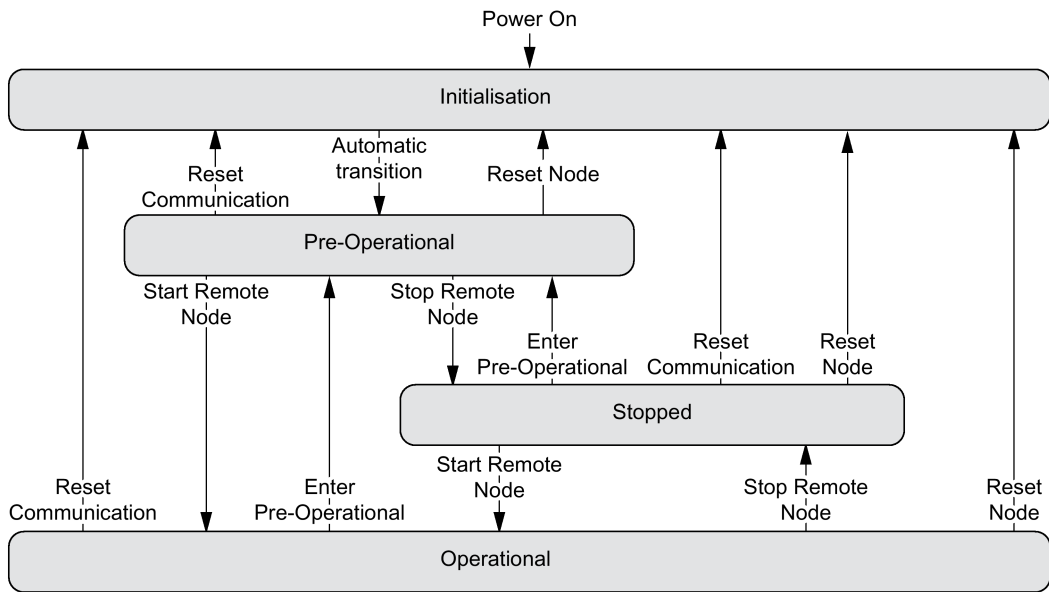

NMT states

The inverter state is displayed in p8685.

You can either change the inverter state via the control with an NMT telegram, using one of the command specifiers listed below, or in the inverter itself using p8685.

- Initialization: p8685 = 0, Command specifier = 0
The inverter initializes itself after power on. In the factory setting, the inverter then enters the "Pre-Operational" state, which also corresponds to the CANopen standard. Using p8684, you can set that after the bus has booted, the inverter does not go into the "Pre-Operational" state, but instead, into the "Stopped" or "Operational" state.
- Pre-Operational, p8685 = 127 (factory setting), Command specifier = 128
In this state, the node cannot process any process data (PDO). However, the controller

can use SDO parameters to change or operate the inverter, which means that you can also enter setpoints via SDO.

- Operational, p8685 = 5; Command specifier = 1
In this state, the nodes can process SDO as well as also PDO.
- Stopped, p8685 = 4; Command specifier = 2
In this state, the nodes can neither process PDO nor SDO. The "Stopped" state terminates one of the following commands:
 - Enter Pre-Operational, p8685 = 127 (factory setting), Command specifier = 128
 - Start Remote Node
 - Reset Node, p8685 = 128, Command specifier = 129
 - Reset Communication, p8685 = 129, Command specifier = 130

Note

Sending an incorrect NMT state

If the control sends an incorrect NMT state to the inverter, the inverter goes into the "Stopped" state.

Request sent by the master to one or several slaves

The NMT master can simultaneously direct a request to one or more slaves. The following is applicable:

- Requirement of a slave:
The controller accesses the slave with its node ID (1 - 127).
- Requirement for all slaves:
Node ID = 0

Boot-up Service

The boot-up protocol indicates the state of the NMT slave after it has booted (factory setting "Pre-operational").

Bootup protocol COB ID = 700 hex + node ID
1 data byte with the value 0 is transmitted.

NMT state after power up

Using parameter p8684, set the state that the inverter goes into after powering up:

- p8684 = 4 Stopped
- p8684 = 5 Operational
- p8684 = 127 Pre-Operational (factory setting)

Node Control Service

The Node Control Services control state transitions

- **Start Remote Node:**
Command for switching from the "Pre-Operational" communication state to "Operational". The drive can only transmit and receive process data (PDO) in "Operational" state.
- **Stop Remote Node:**
Command for switching from "Pre-Operational" or "Operational" to "Stopped". The node only processes NMT commands in the "Stopped" state.
- **Enter Pre-Operational:**
Command for switching from "Operational" or "Stopped" to "Pre-Operational". In this state, the node cannot process any process data (PDO). However, the controller can use SDO parameters to change or operate the inverter, which means that you can also enter setpoints via SDO.
- **Reset Node:**
Command for switching from "Operational", "Pre-Operational" or "Stopped" to "Initialization". When the Reset Node command is issued, the inverter resets all the objects (1000 hex - 9FFF hex) to the state that was present after "Power On".
- **Reset Communication:**
Command for switching from "Operational", "Pre-Operational" or "Stopped" to "Initialization". When the Reset Communication command is issued, the inverter resets all the communication objects (1000 hex - 1FFF hex) to the state that was present after "Power On".

Command specifier and node_ID indicate the transition states and addressed nodes.

Error Control Service

"Node Guarding / Life Guarding" or "Heartbeat" monitor communication.

Setting options and default settings.

 Setting the monitoring of the communication (Page 208)

6.2 SDO services

You can access the object directory of the connected drive unit using the SDO services. An SDO connection is a peer-to-peer coupling between an SDO client and a server.

The drive unit with its object directory is an SDO server.

The identifiers for the SDO channel of a drive unit are defined according to CANopen as follows.

Receiving:	Server \leftarrow client:	COB ID = 600 hex + node ID
Transmitting:	Server \Rightarrow client:	COB ID = 580 hex + node ID

Properties

The SDOs have the following properties:

- An SDO connection exists only in the Pre-Operational and Operational states
- Transmission is confirmed
- Asynchronous transmission (matches the acyclical communication via PROFIBUS DB)
- Transmission of values > 4 bytes (normal transfer)
- Transmission of values \leq 4 bytes (expedited transfer)
- All drive unit parameters can be addressed via SDO

6.2.1 Access to SINAMICS parameters via SDO

You access SINAMICS parameters using the SDO service. To do this, you use objects 2000 hex ... 470F hex of the manufacturer-specific area of the object directory.

Because you cannot directly address all of the parameters using this area, you require for an SDO job always the parameter number itself and the offset dependent on the parameter number.

Selection of parameter range and the associated offset

Parameter range	Offset	Offset value
$0 < \text{parameter number} < 10000$	p8630[2] = 0	0
$10000 \leq \text{parameter number} < 20000$	p8630[2] = 1	10000
$20000 \leq \text{parameter number} < 20000$	p8630[2] = 2	20000
$30000 \leq \text{parameter number} < 20000$	p8630[2] = 3	30000

Calculate object number for an SDO job

The object number for the SDO job is calculated as follows:

object number hex = (number of the inverter parameter - offset value) hex + 2000 hex

Examples of object numbers

Parameter	Number of the inverter parameter - offset value		Object number
	Decimal	Hexadecimal	
• p0010:	10 dec	A hex	⇒ 200A hex
• p11000:	1000 dec	3E8 hex	⇒ 23E8 hex
• r20001:	1 dec	1 hex	⇒ 2001 hex
• p31020:	1020 dec	3FC hex	⇒ 23FC hex

Selection, index range

A CANopen object can contain a maximum of 255 indexes. For parameters with more than 255 indexes, you must create additional CANopen objects via p8630[1]. Overall, 1024 indexes are possible.

- p8630[1] = 0: 0 ... 255
- p8630[1] = 1: 256 ... 511
- p8630[1] = 2: 512 ... 767
- p8630[1] = 3: 768 ... 1023

Switch-on access to objects of the inverter parameters

Access to objects of the inverter parameters is activated via p8630[0], where:

- p8630[0] = 0: only access to CANopen objects
- p8630[0] = 1: access to virtual CANopen objects (inverter parameters)
- p8630[0] = 2: not relevant for G120 inverters

A selection of important manufacturer-specific objects is included in the EDS file.

6.2.2 Access PZD objects via SDO

Access to mapped PZD objects

When you access objects mapped via transmit or receive telegrams, you can access the process data without additional settings.

Overview



Figure 6-1 Access to mapped PZD setpoint objects

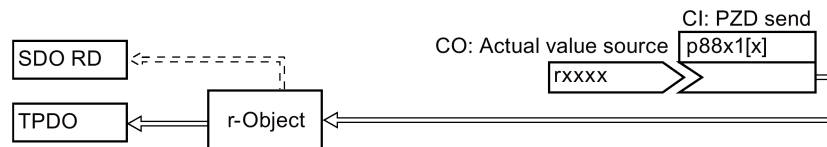

Figure 6-2 Access to mapped PZD actual value objects

Example, access to object 6042 hex

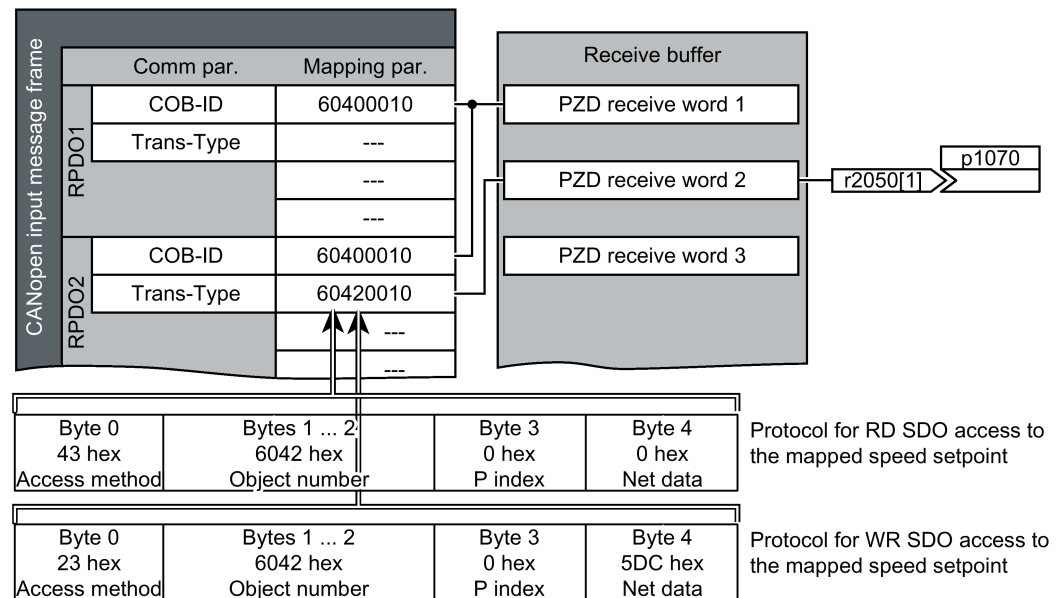

Figure 6-3 Access to the process data

Access to non-mapped PZD objects

When you access objects that are not interconnected via the receive or transmit telegram, you must also establish the interconnection with the corresponding CANopen parameters.

Overview



Figure 6-4 Access to non-mapped PZD setpoint objects

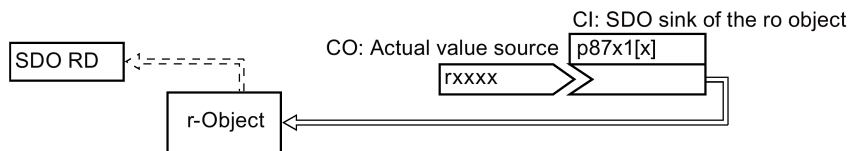

Figure 6-5 Access to non-mapped free PZD actual value objects

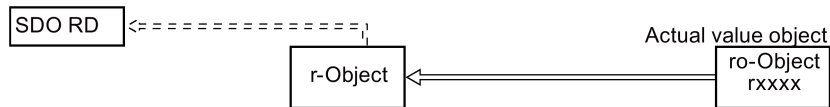

Figure 6-6 Access to non-mapped standardized PZD actual value objects

Example for interconnecting the control word with CANopen parameters:

ON/OFF1	p840[0] = r8795.0
No coast down activated	p0844[0] = r8795.1
No fast stop activated	p0848[0] = r8795.2
Enable operation	p0852[0] = r8795.3
Enable ramp-function generator	p1140[0] = r8795.4
Continue ramp-function generator	p1141[0] = r8795.5
Enable speed setpoint	p1142[0] = r8795.6
Acknowledge fault	p2103[0] = r8795.7
Stop	p8791 = r8795.8

6.3 PDO services

Process data objects (PDO)

CANopen transfers the process data using "Process Data Objects" (PDO). There are send PDOs (TPDO) and receive PDOs (RPDO). CAN controller and inverter each exchange up to eight TPDOs and RPDOs.

PDO communication parameters and PDO mapping parameters define a PDO.

Link the PDO with the elements of the object directory that contain the process data.



Free PDO mapping (Page 184)



Predefined connection set (Page 182) .

Parameter area for PDO	RPDO		TPDO	
	In the inverter	In CANopen	In the inverter	In CANopen
Communication parameters	p8700 ... p8707	1400 hex ... 1407 hex	p8720 ... p8727	1800 hex ... 1807 hex
Mapping parameters	p8710 ... p8717	1600 hex ... 1607 hex	p8730 ... p8737	1A00 hex ... 1A07 hex

Structure of the PDO

A PDO consists of communication and mapping parameters. Examples for the structure of the TPDO and RPDO follow.

Values for communication parameters:



Tables in the Section Object directories (Page 194)

Structure of the RPDO using RPDO1 as example

p8700[0] = COB-ID	p8700[1] = Trans-Type	p8710.0_xx_yy	p8710.1_xx_yy	p8710.2_xx_yy	p8710.3_xx_yy
Sub-Ind 01	Sub-Ind 02	Object 1	Object 2	Object 3	Object 4
Communication parameters		Mapping parameters			

Structure of the TPDO using TPDO1 as example

p8720[0] = COB-ID	p8720[1] = Trans-Type	p8720[2] = Inhibit time	p8720[4] = Event timer	p8730.0_xx_yy	p8730.1_xx_yy	p8730.2_xx_yy	p8730.3_xx_yy
Sub-Ind 01	Sub-Ind 02	Sub-Ind 03	Sub-Ind 05	Object 1	Object 2	Object 3	Object 4
Communication parameters				Mapping parameters			

Structure of the mapping parameter using the first mapped object as example

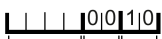

Object length (hex, two positions), 10 for 16-bit values, 20 for 32-bit values

Sub index (two positions), for G120 always 00

OV index (four positions), value of p8710.0 for RPDO, of p8730.0 for TPDO

Figure 6-7 Structure of the RPDO and TPDO communication objects

COB ID

Overview:  Communication over CANopen (Page 169).

Calculating the COB IDs:  Predefined connection set (Page 182)

Transmission type

For process data objects, the following transmission types are available, which you set in index 1 of the communication parameter (p8700[1] ... p8707[1] / p8720[1] ... p8727[1]) in the inverter:

- Synchronous cyclic (value range: 1 ... 240)
 - TPDO after each n-th SYNC
 - RPDO after each n-th SYNC
- Acyclic synchronous (value: 0)
 - TPDO when a SYNC is received and a process data has changed in the telegram.
- Cyclic asynchronous (values: 254, 255 + event time)
 - TPDO when a process data has changed in the telegram.
- Acyclic asynchronous (values: 254, 255)
 - TPDO sent in the Event Time interval.
 - The controller accepts the RPDO immediately.

- Synchronous data transmission

A periodic synchronization object (SYNC object) ensures that the devices on the CANopen bus remain synchronized during transmission.

Each PDO transferred as synchronization object must include a "transmission type" 1 ... n:

- Transmission type 1: PDO in each SYNC cycle
- Transmission type n: PDO in every n-th SYNC cycle

The following diagram shows the principle of synchronous and asynchronous transmission:

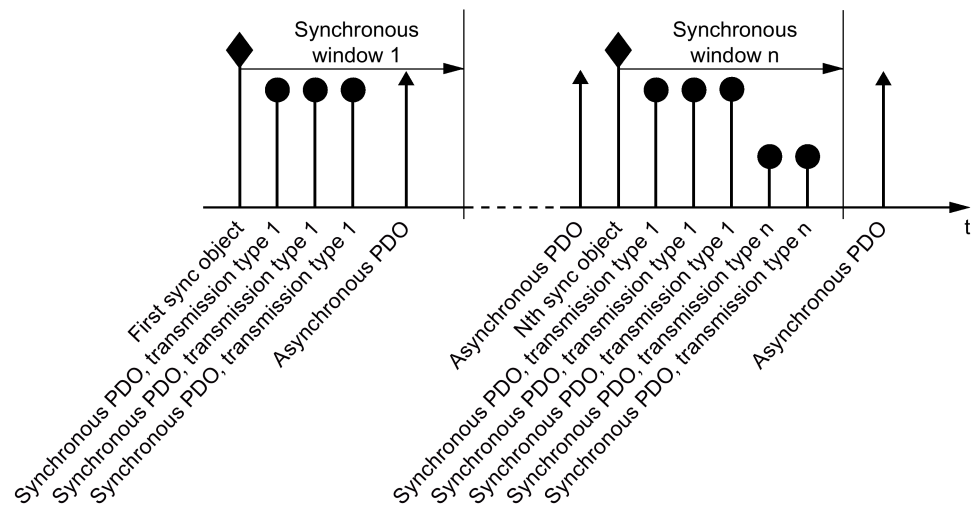

Figure 6-8 Principle of synchronous and asynchronous transmission

For synchronous TPDOs, the transmission mode also identifies the transmission rate as a factor of the SYNC object transmission intervals.

The CAN controller transfers data from synchronous RPDOs that it received after a SYNC signal only after the next SYNC signal to the inverter.

Note

The SYNC signal synchronizes only the communication on the CANopen bus and not functions in the inverter, e.g. the clock times of the speed control.

Inhibit time

The inhibit time defines the minimum interval between two transmissions.

PDO services

The following services are available for CANopen:

- PDO Write protocol
- PDO Read protocol

SINAMICS inverters support the PDO Write protocol

Write PDO

The "PDO Write protocol" service is based on the push model. The PDO has exactly one producer. There can be no consumer, one consumer, or multiple consumers.

Via Write PDO, the producer of the PDO sends the data of the mapped application object to the individual consumer.

6.3.1 Predefined connection set

If you integrate the inverter using the factory setting in CANopen, the inverter receives the control word and the speed setpoint from the controller. The inverter returns the status word and the actual speed value to the controller. These are the settings stipulated in the Predefined Connection Set.

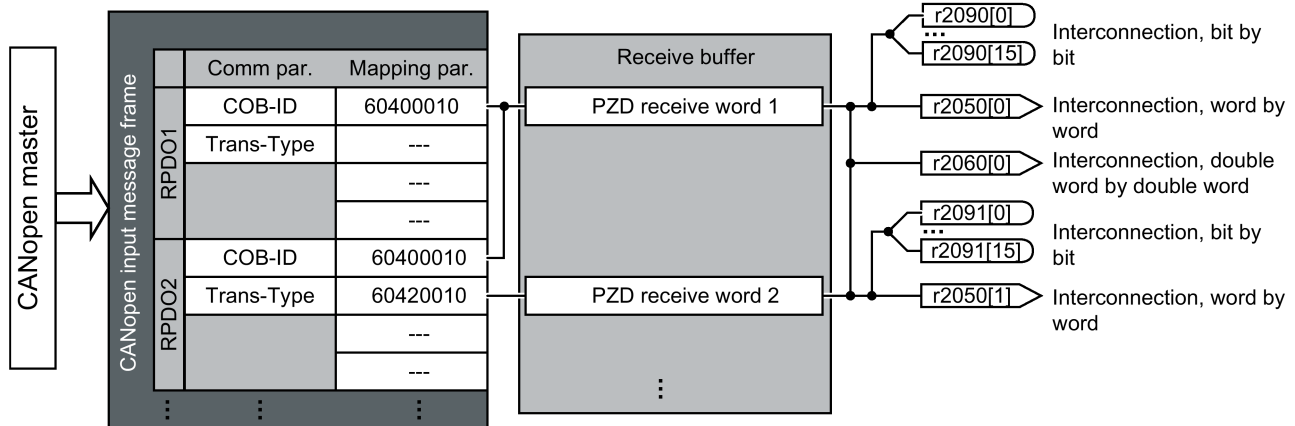

Structure of the communication parameter using the control word in the predefined connections set as example

- RPDO1: Communication parameter
- p8700[0] = COB-ID
- p8700[1] = transmission type

Structure of the mapping parameter using the control word in the predefined connections set as example

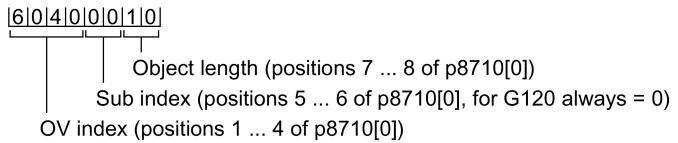
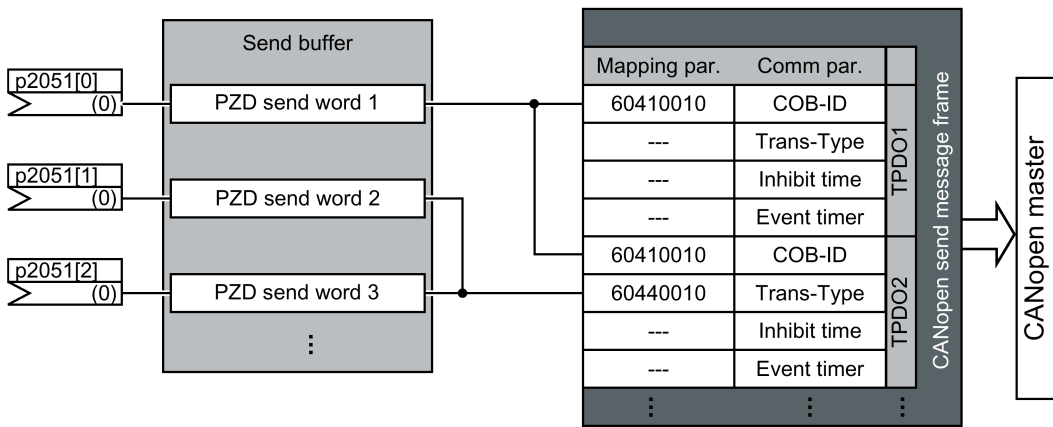

Figure 6-9 RPDO mapping with the Predefined Connection Set



Structure of the communication parameter using the status word in the predefined connections set as example

- TPDO1: Communication parameter
- p8720[0] = COB-ID
 - p8700[1] = transmission type
 - p8700[2] = inhibit time
 - p8700[3] = event timer

Structure of the mapping parameter using the control word in the predefined connections set as example

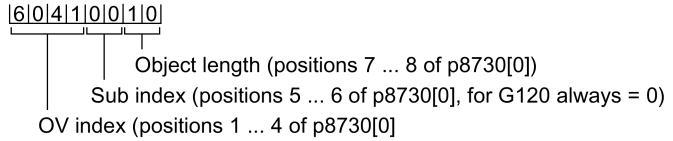



Figure 6-10 TPDO mapping with the Predefined Connection Set

6.3.2 Free PDO mapping





Using the free PDO mapping, you configure and interconnect any process data as required as follows:

- as free objects  free objects (Page 203) or
- as objects of drive profile CiA 402, corresponding to the requirements of your system for the PDO service

The precondition is that the inverter is set for free PDO mapping. (p8744 = 2) (factory setting).

Configuring and mapping process data using free PDO mapping

Procedure

1. Specify the process data.
Examples:
 - Send current actual value (r0068) from the inverter to the controller (TPDO - Transmit Process Data Object)
 - Send additional speed setpoint from the controller to the inverter (RPDO - Receive Process Data Object) and write in p1075
2. Specify objects for transmission of the process data
 - TPDO1 for the current actual value
 - RPDO1 for additional speed setpoint
3. Define the communication parameters for RPDO and TPDO
 - Define communication parameters for RPDO.
 RPDO communication parameters (Page 196)
 - Define communication parameters for TPDO.
 See TPDO communication parameters (Page 199)
4. Select the OV index for the mapping parameters
 - Mapping parameters for RPDO.
 RPDO mapping parameters (Page 197)
 - Mapping parameters for TPDO.
 TPDO mapping parameters (Page 201)
5. Write OV index into the SINAMICS mapping parameters
 - p8710 ... p8717 for RPDO
 - p8730 ... p8737 for TPDO

Note

Precondition for changing the OD indexes of the SINAMICS mapping parameters

To allow you to change the values of the mapping parameters, you must set the COB ID of the corresponding parameter to invalid. To do this, add a value of 80000000 hex to the COB-ID. You must reset the COB-ID to a valid value once you changed the mapping parameters.

OV index:

 Free objects (Page 203)

 Objects of the drive profile CiA 402 (Page 204)

You have now configured and mapped the process data.



Free RPDO mapping - Overview

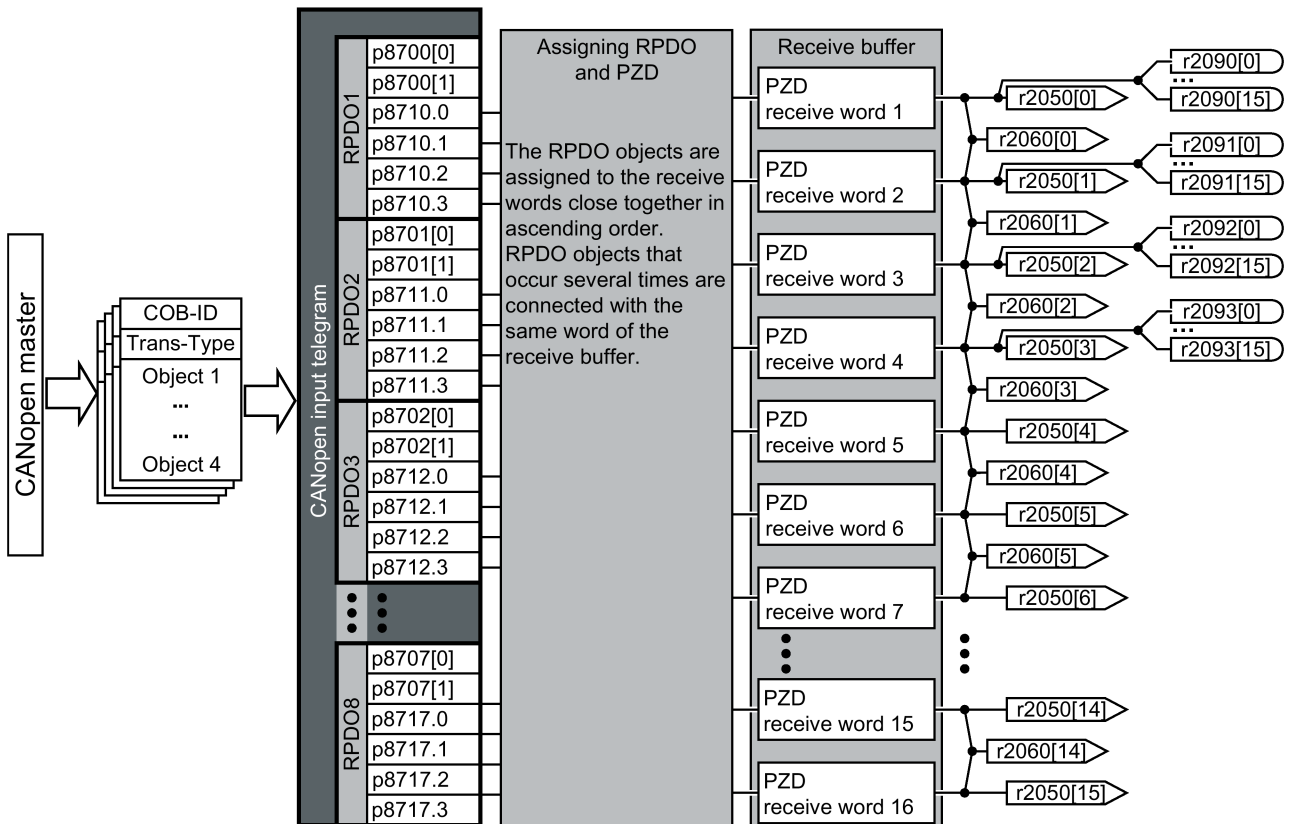

Interconnection options:
 ▶ bit-by-bit with r2090 ... r2093
 ▶ word-by-word with r2050[0 ... 15]
 ▶ double word-by-double word with r2060[0 ... 14]

Free TPDO mapping - Overview

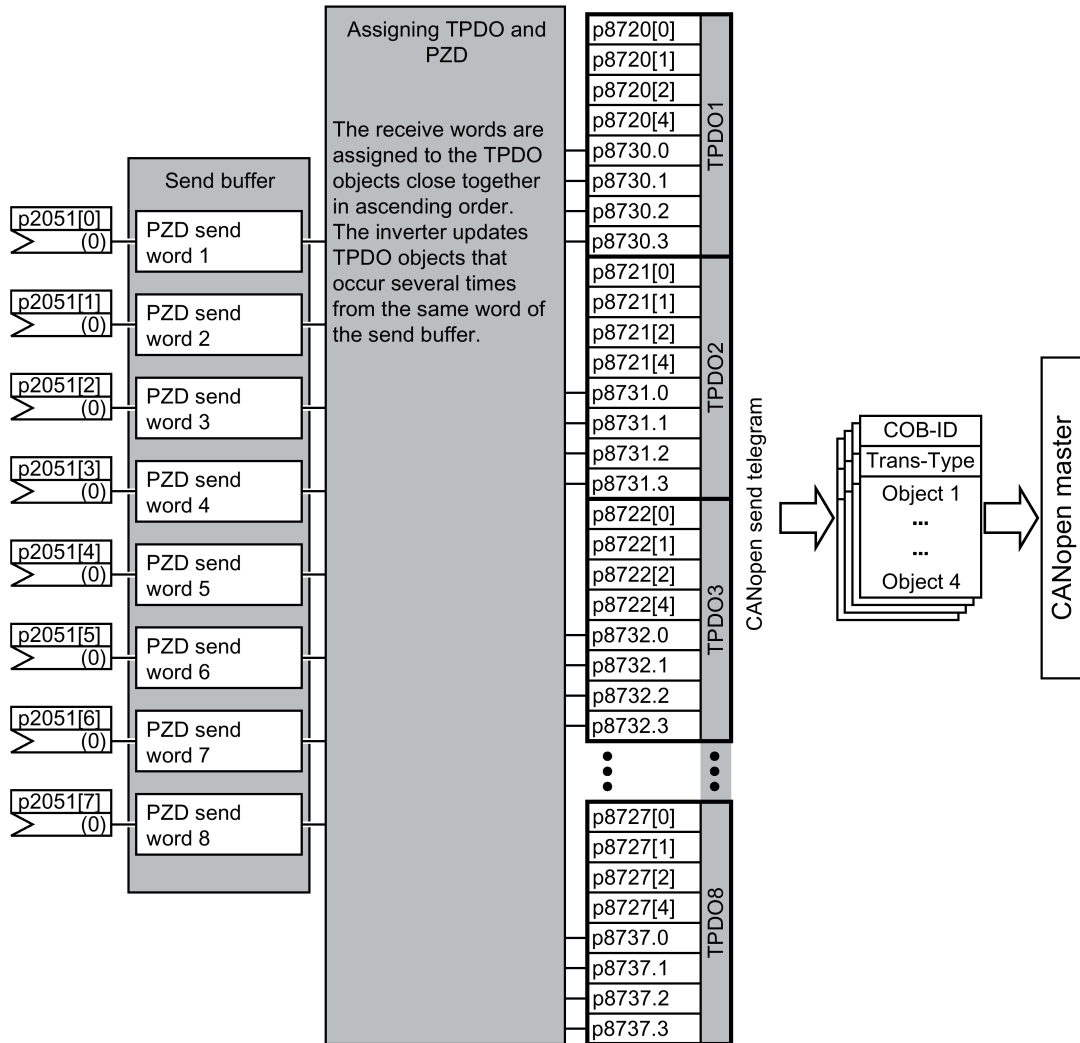



6.3.3 Interconnect objects from the receive and transmit buffers

To interconnect process data, proceed as follows:

Procedure

1. Create a telegram:
create PDO (parameterize the PDO Com. Parameters and PDO mapping parameters).

 Predefined connection set (Page 182)

 Free PDO mapping (Page 184)

2. Interconnect parameters:
Interconnect the parameters of the PZD buffer (r2050/r2060, p2051/p2061) corresponding to the mapping of point "Create telegram" using the mapping table r8750/r8760 or r8751/r8761. The mapping table indicates the position of a mapped CANopen object in the PZD buffer.

You have now interconnected the process data.



Interconnecting the receive buffer

The inverter writes the received data in the receive buffer:

- PZD receive word 1 ... PZD receive word 12 double word in r2060[0] ... r2060[10].
- PZD receive word 1 ... PZD receive word 12 word in r2050[0] ... r2050[11].
- PZD 1 ... PZD 4 bit-by-bit in r2090.0 ... r2090.15 to r2093.0 ... r2093.15

The position of the mapped objects in the receive buffer is displayed in:

- r8760 for double word switching
- r8750 for word switching

Examples

Object	Mapped receive objects	Receive word r2050	
Control word	r8750[0] = 6040 hex (PZD1)	Interconnect r2050[0] (PZD1) in control word ¹⁾	p0840.0 = 2090.0 p0844.0 = 2090.1 p08484.0 = 2090.2 p0852.0 = 2090.3 p2130.0 = 2090.7
Torque limit	r8750[1] = 5800 hex (PZD2)	Interconnect r2050[1] (PZD2) in the torque limit:	p1522 = 2050[1]
Speed setpoint	r8750[2] = 6042 hex (PZD3)	Interconnect r2050[2] (PZD3) in the speed setpoint:	p1070 = 2050[2]

1) see also p8790, "Automatic CAN control word interconnection"

Interconnecting the send buffer

The inverter sends the data from the send buffer as follows:

- p2051[0] ... p2051[13] in PZD 1 ... PZD 14 (indication of the actual values in r2053[0 ... 13])
- p2061[0] ... p2061[12] in PZD 1 ... PZD 14 (indication of the actual values in r2063[0 ... 12])

Examples

Object	Mapped send objects	Send word p2051	
Status word	r8751[0] = 6041 hex (PZD1)	Interconnect p2051[0] in PZD1	p2051[0] = r8784
Current actual value	r8751[1] = 5810 hex (PZD2)	Interconnect PZD2 in the current actual value	p2051[1] = r68[1]
Actual speed value	r8751[2] = 6044 hex (PZD3)	Interconnect PZD3 in the speed actual value	p2051[2] = r63[0]

6.3.4 Free PDO mapping for example of the actual current value and torque limit

You integrate the actual current value and torque limit into the communication via the free PDO mapping.

The actual current value and the torque setpoint are transferred in TPDO1 and RPDO1, respectively. TPDO1 and RPDO1 have already been specified by the Predefined Connection Set.

Mapping the actual current value (r0068) with TPDO1

Proceed as follows to accept the current actual value as send object in the communication:

Procedure

1. Set the OV index for the actual current value:
first free OV index from the send data from the "Free objects" 5810 table
2. Map the OV index for the actual current value with PZD2:
 - Set the COB-ID of TPDO1 to "invalid":
p8720[0] = 800001B2 hex
 - Link the mapping parameter object 2 of TPDO1 (p8730.1) with the OV index for the actual current value:
p8730.1 = 58100010 hex (5810 = OV index, 00 = fixed value, 10 $\hat{=}$ 16 bit value)
 - Set the COB-ID of TPDO1 to "valid":
p8720[0] = 400001B2 hex

r8751 shows which object is matched to which PZD:
PZD2 (r8751[1]) = 5810 (actual current value)
3. link the PZD send word 2 in the send word (p2051) with the actual current value:
p2051[1] = r0086[0]

You have now transferred the actual current value into the communication as the send object.

□

Mapping the torque limit (p1520) with RPDO1

Proceed as follows to accept the torque limit value in the communication:

Procedure

1. Set the OV index for the torque limit:
first free OV index from the receive data from the "Free objects" 5800 table
2. Map the OV index for the torque limit with PZD2
 - Set the COB-ID of RPDO1 to "invalid":
p8700[0] = 80000232 hex
 - Link the mapping parameter object 2 of RPDO1 (p8710.1) with the OV index for the torque limit:
p8710.1 = 58000010 hex (5800 = OV index, 00 = fixed value)

6.3 PDO services

- Set the COB-ID of RPDO1 to "valid":
p8700[0] = 4000232 hex

r8750 shows which object is mapped to which PZD:
PZD2 (r8750[1]) = 5800 (torque limit)

3. Link the PZD receive word 2 in the receive word (p2050) with the torque limit:
p2050[1] = p1520[0]

You have now transferred the value for the torque limit into the communication.



6.4 CANopen operating modes

The inverter has the following CANopen operating modes

CANopen operating mode			SINAMICS				
Active operating mode	Setting in 6060 h:	6502 h: Display the active operating mode in	Open-loop/closed-loop control mode	Control Unit / inverter			Value in p1300
	Value			CU230P-2 CAN	G120C CAN	CU250S-2 CAN	
Velocity Mode	2	Bit1	U/f control with linear characteristic	x	x	x	0
Manufacturer-specific operating mode 1	-1	Bit16	U/f control with linear characteristic and FCC	x	x	x	1
Manufacturer-specific operating mode 2	-2	Bit17	U/f control with parabolic characteristic	x	x	x	2
Manufacturer-specific operating mode 3	-3	Bit18	U/f control with parameterizable characteristic		X	x	3
Manufacturer-specific operating mode 4	-4	Bit19	U/f control with linear characteristic and ECO	x	x	x	4
Manufacturer-specific operating mode 5	-5	Bit20	U/f control for drive requiring a precise frequency (e.g. textiles)		X	x	5
Manufacturer-specific operating mode 6	-6	Bit21	U/f control for drive requiring a precise frequency and FCC		X	x	6
Manufacturer-specific operating mode 7	-7	Bit22	U/f control with parabolic characteristic and ECO	x	x	x	7
Manufacturer-specific operating mode 8	-15	Bit23	Operation with braking resistor			x	15
Manufacturer-specific operating mode 10	-19	Bit25	U/f control with independent voltage setpoint		x	x	19
Manufacturer-specific operating mode 11	-20	Bit26	Speed control (without encoder)	x	x	x	20
Profile Velocity Mode	3	Bit2	Speed control (with encoder)			x	21
Manufacturer-specific operating mode 12	-22	Bit27	Torque control (without encoder)			x	22
Profile Torque Mode	4	Bit3	Closed-loop torque control (with encoder)			x	23

Switching the CANopen operating modes

	Switching from		
	Velocity mode	Profile velocity mode	Profile torque mode
Velocity mode		p1300 < 20 V/f control	p1300 < 20 V/f control
Profile velocity mode	p1300 = 20 / 21 Speed control		p1500 = 0 (via BiCo), speed control
Profile torque mode	p1300 = 22 / 23 Speed control	p1500 = 1 (via BiCo), torque control	

Parameter access via SDO

Parameter change via PDO

You can also use parameters from other CANopen operating modes, independently from the current effective CANopen operating mode.

6.5 RAM to ROM via the CANopen object 1010

Save the parameters of the inverter EEPROM using CANopen object 1010.

The following options are available:

- 1010.1: Save all parameters - identical with p0971 = 1, or back them up so they are not lost if the power fails.
- 1010.2: Save communication parameters - not possible via parameter settings!
- 1010.3: Save application parameters - not possible via parameter settings!

If a memory card is inserted, write the parameter settings via the control with object 1010.1 into the EEPROM and to the memory card. You can carry out series commissioning with the memory card.

For additional information, please refer to the operating instructions, Chapter "Backing up data and series commissioning"



Overview of the manuals (Page 232),

Note

Save data using objects 1010.2 and 1010.3

Although you can write the communication and/or application parameters to the EEPROM using objects 1010.2 and 1010.3, you cannot write them to the memory card. This also means that it is not possible to load the communication data or only the application data from one inverter into the next via the memory card.

Note

With the USB cable inserted, save the data in the inverter via the control.

If the inverter is connected with a computer via USB but Startdrive cannot access the inverter online, then you cannot save data in the inverter using CANopen object 1010.

Withdraw the USB cable from the inverter if you wish to save the parameter setting with object 1010.1 in the inverter via the control.

6.6 Object directories

6.6.1 General objects from the CiA 301 communication profile

Overview

The following table lists the drive-independent communication objects. The "SINAMICS parameters" column shows the parameter numbers assigned in the converter.

Table 6- 2 Drive-independent communication objects

OD index (hex)	Subindex (hex)	Object name	SINAMICS parameters	Transmission	Data type	Default values	Can be read/written
1000		Device type	r8600	SDO	U32	–	r
1001		Error register	r8601	SDO	U8	–	r
1003	0...52 hex	Predefined error field	p8611[0...82]	SDO	U32	0	r/w
	0	Number of errors	p8611.0	SDO	U32	0	rw
	1	Number of module	p8611.1	SDO	U32	0	r
	2	Number of errors: module 1	p8611.2	SDO	U32	0	r
	3-A	Standard error field: module 1	p8611.3- p8611.10	SDO	U32	0	r
	B	Number of errors: module 2	p8611.11	SDO	U32	0	r
	C-13	Standard error field: module 2	p8611.12- p8611.19	SDO	U32	0	r
	14	Number of errors: module 3	p8611.20	SDO	U32	0	r
	15-1C	Standard error field: module 3	p8611.21- p8611.28	SDO	U32	0	r
	1D	Number of errors: module 4	p8611.29	SDO	U32	0	r
	1E-25	Standard error field: module 4	p8611.30-p8611.37	SDO	U32	0	r
	26	Number of errors: module 5	p8611.38	SDO	U32	0	r
	27-2E	Standard error field: module 5	p8611.39-p8611.46	SDO	U32	0	r
	2F	Number of errors: module 6	p8611.47	SDO	U32	0	r
	30-37	Standard error field: module 6	p8611.48-p8611.55	SDO	U32	0	r
	38	Number of errors: module 7	p8611.56	SDO	U32	0	r
	39-40	Standard error field: module 7	p8611.57-p8611.64	SDO	U32	0	r
	41	Number of errors: module 8	p8611.65	SDO	U32	0	r
	42-49	Standard error field: module 8	p8611.66-p8611.73	SDO	U32	0	r
	4A	Number of Control Unit faults	p8611.74	SDO	U32	0	r
	4B-52	Field Control Unit standard error	p8611.75-p8611.82	SDO	U32	0	r
1005		SYNCH COB ID	p8602	SDO	U32	128	rw
1008		Manufacturer device name		SDO			
100A		Manufacturer software version	r0018	SDO	U32	–	r
100C		Guard time	p8604.0	SDO	U16	0	rw
100D		Lifetime factor	p8604.1	SDO	U16	0	rw

OD index (hex)	Subindex (hex)	Object name	SINAMICS parameters	Transmission	Data type	Default values	Can be read/written
1010		Store parameters	p0971	SDO	U16	0	rw
	0	Largest subindex supported		SDO			
	1	Save all parameters	p0971	SDO	U16	0	rw
	2	Save communication parameters (0x1000-0x1fff)	p0971	SDO	U16	0	rw
	3	Save application-related parameters (0x6000-0x9fff)	p0971	SDO	U16	0	rw
1011		Restore default parameters	p0970	SDO	U16	0	rw
	0	Largest subindex supported		SDO			
	1	Restore all default parameters	p0970	SDO	U16	0	rw
	2	Restore communication default parameters (0x1000-0x1fff)	p0970	SDO	U16	0	rw
	3	Restore application default parameters (0x6000-0x9fff)	p0970	SDO	U16	0	rw
1014		COB ID emergency	p8603	SDO	U32	0	rw
1017		Producer heartbeat time	p8606	SDO	U16	0	rw
1018		Identy Object	r8607[0...3]		U32	-	r
	0	Number of entries		SDO			
	1	Vendor ID	r8607.0	SDO	U32	-	r
	2	Product code	r8607.1	SDO	U32	-	r
	3	Revision number	r8607.2	SDO	U32	-	r
	4	Serial number	r8607.3	SDO	U32	0	r
1027		Module list					
	0	Number of entries	r0102	SDO	U16	-	r
	1-8	Module ID	p0107[0...15]	SDO	l16	0	rw
1029		Error behavior					
	0	Number of error classes		SDO			
	1	Communication Error	p8609.0	SDO	U32	1	rw
	2	Device profile or manufacturer-specific error	p8609.1	SDO	U32	1	rw
1200		1st server SDO parameter					
	0	Number of entries		SDO			
	1	COB ID client -> server (rx)	r8610.0	SDO	U32	-	r
	2	COB ID server -> client (tx)	r8610.1	SDO	U32	-	r

RPDO configuration objects

The following tables list the communication and mapping parameters together with the indexes for the individual RPDO configuration objects. The configuration objects are established via SDO. The "SINAMICS parameters" column shows the parameter numbers assigned in the converter.

Table 6- 3 RPDO configuration objects - communication parameters

OD Index (hex)	Sub-index (hex)	Name of the object	SINAMICS parameters	Data type	Predefined connection set	Can be read/ written to
1400		Receive PDO 1 communication parameter				
	0	Largest subindex supported		U8	2	r
	1	COB ID used by PDO	p8700.0	U32	200 hex + node ID	r/w
	2	Transmission type	p8700.1	U8	FE hex	r/w
1401		Receive PDO 2 communication parameter				
	0	Largest subindex supported		U8	2	r
	1	COB ID used by PDO	p8701.0	U32	300 hex + node ID	r/w
	2	Transmission type	p8701.1	U8	FE hex	r/w
1402		Receive PDO 3 communication parameter				
	0	Largest subindex supported		U8	2	r
	1	COB ID used by PDO	p8702.0	U32	8000 06DF hex	r/w
	2	Transmission type	p8702.1	U8	FE hex	r/w
1403		Receive PDO 4 communication parameter				
	0	Largest subindex supported		U8	2	r
	1	COB ID used by PDO	p8703.0	U32	8000 06DF hex	r/w
	2	Transmission type	p8703.1	U8	FE hex	r/w
1404		Receive PDO 5 communication parameter				
	0	Largest subindex supported		U8	2	r
	1	COB ID used by PDO	p8704.0	U32	8000 06DF hex	r/w
	2	Transmission type	p8704.1	U8	FE hex	r/w
1405		Receive PDO 6 communication parameter				
	0	Largest subindex supported		U8	2	r
	1	COB ID used by PDO	p8705.0	U32	8000 06DF hex	r/w
	2	Transmission type	p8705.1	U8	FE hex	r/w
1406		Receive PDO 7 communication parameter				
	0	Largest subindex supported		U8	2	r
	1	COB ID used by PDO	p8706.0	U32	8000 06DF hex	r/w
	2	Transmission type	p8706.1	U8	FE hex	r/w
1407		Receive PDO 8 communication parameter				
	0	Largest subindex supported		U8	2	r
	1	COB ID used by PDO	p8707.0	U32	8000 06DF hex	r/w
	2	Transmission type	p8707.1	U8	FE hex	r/w

Table 6- 4 RPDO configuration objects - mapping parameters

OD index (hex)	Sub-index (hex)	Name of the object	SINAMICS parameters	Data type	Predefined connection set	Can be read/written to
1600		Receive PDO 1 mapping parameter				
	0	Number of mapped application objects in PDO		U8	1	r
	1	PDO mapping for the first application object to be mapped	p8710.0	U32	6040 hex	r/w
	2	PDO mapping for the second application object to be mapped	p8710.1	U32	0	r/w
	3	PDO mapping for the third application object to be mapped	p8710.2	U32	0	r/w
	4	PDO mapping for the fourth application object to be mapped	p8710.3	U32	0	r/w
1601		Receive PDO 2 mapping parameter				
	0	Number of mapped application objects in PDO		U8	2	r
	1	PDO mapping for the first application object to be mapped	p8711.0	U32	6040 hex	r/w
	2	PDO mapping for the second application object to be mapped	p8711.1	U32	6042 hex	r/w
	3	PDO mapping for the third application object to be mapped	p8711.2	U32	0	r/w
	4	PDO mapping for the fourth application object to be mapped	p8711.3	U32	0	r/w
1602		Receive PDO 3 mapping parameter				
	0	Number of mapped application objects in PDO		U8	0	r
	1	PDO mapping for the first application object to be mapped	p8712.0	U32	0	r/w
	2	PDO mapping for the second application object to be mapped	p8712.1	U32	0	r/w
	3	PDO mapping for the third application object to be mapped	p8712.2	U32	0	r/w
	4	PDO mapping for the fourth application object to be mapped	p8712.3	U32	0	r/w
1603		Receive PDO 4 mapping parameter				
	0	Number of mapped application objects in PDO		U8	0	r
	1	PDO mapping for the first application object to be mapped	p8713.0	U32	0	r/w
	2	PDO mapping for the second application object to be mapped	p8713.1	U32	0	r/w
	3	PDO mapping for the third application object to be mapped	p8713.2	U32	0	r/w
	4	PDO mapping for the fourth application object to be mapped	p8713.3	U32	0	r/w
1604		Receive PDO 5 mapping parameter				
	0	Number of mapped application objects in PDO		U8	0	r

6.6 Object directories

OD index (hex)	Sub-index (hex)	Name of the object	SINAMICS parameters	Data type	Predefined connection set	Can be read/written to
	1	PDO mapping for the first application object to be mapped	p8714.0	U32	0	r/w
	2	PDO mapping for the second application object to be mapped	p8714.1	U32	0	r/w
	3	PDO mapping for the third application object to be mapped	p8714.2	U32	0	r/w
	4	PDO mapping for the fourth application object to be mapped	p8714.3	U32	0	r/w
1605		Receive PDO 6 mapping parameter				
	0	Number of mapped application objects in PDO		U8	0	r
	1	PDO mapping for the first application object to be mapped	p8715.0	U32	0	r/w
	2	PDO mapping for the second application object to be mapped	p8715.1	U32	0	r/w
	3	PDO mapping for the third application object to be mapped	p8715.2	U32	0	r/w
	4	PDO mapping for the fourth application object to be mapped	p8715.3	U32	0	r/w
1606		Receive PDO 7 mapping parameter				
	0	Number of mapped application objects in PDO		U8	0	r
	1	PDO mapping for the first application object to be mapped	p8716.0	U32	0	r/w
	2	PDO mapping for the second application object to be mapped	p8716.1	U32	0	r/w
	3	PDO mapping for the third application object to be mapped	p8716.2	U32	0	r/w
	4	PDO mapping for the fourth application object to be mapped	p8716.3	U32	0	r/w
1607		Receive PDO 8 mapping parameter				
	0	Number of mapped application objects in PDO		U8	0	r
	1	PDO mapping for the first application object to be mapped	p8717.0	U32	0	r/w
	2	PDO mapping for the second application object to be mapped	p8717.1	U32	0	r/w
	3	PDO mapping for the third application object to be mapped	p8717.2	U32	0	r/w
	4	PDO mapping for the fourth application object to be mapped	p8717.3	U32	0	r/w

TPDO configuration objects

The following tables list the communication and mapping parameters together with the indexes for the individual TPDO configuration objects. The configuration objects are established via SDO. The "SINAMICS parameters" column shows the parameter numbers assigned in the converter.

Table 6- 5 TPDO configuration objects - communication parameters

OD index (hex)	Sub-index (hex)	Object name	SINAMICS parameters	Data type	Predefined connection set	Can be read/written
1800		Transmit PDO 1 communication parameter				
	0	Largest subindex supported		U8	5	r
	1	COB ID used by PDO	p8720.0	U32	180 hex + node ID	r/w
	2	Transmission type	p8720.1	U8	FE hex	r/w
	3	Inhibit time	p8720.2	U16	0	r/w
	4	Reserved	p8720.3	U8	---	r/w
	5	Event timer	p8720.4	U16	0	r/w
1801		Transmit PDO 2 communication parameter				
	0	Largest subindex supported		U8	5	r
	1	COB ID used by PDO	p8721.0	U32	280 hex + node ID	r/w
	2	Transmission type	p8721.1	U8	FE hex	r/w
	3	Inhibit time	p8721.2	U16	0	r/w
	4	Reserved	p8721.3	U8	---	r/w
	5	Event timer	p8721.4	U16	0	r/w
1802		Transmit PDO 3 communication parameter				
	0	Largest subindex supported		U8	5	r
	1	COB ID used by PDO	p8722.0	U32	C000 06DF hex	r/w
	2	Transmission type	p8722.1	U8	FE hex	r/w
	3	Inhibit time	p8722.2	U16	0	r/w
	4	Reserved	p8722.3	U8	---	r/w
	5	Event timer	p8722.4	U16	0	r/w
1803		Transmit PDO 4 communication parameter				
	0	Largest subindex supported		U8	5	r
	1	COB ID used by PDO	p8723.0	U32	C000 06DF hex	r/w
	2	Transmission type	p8723.1	U8	FE hex	r/w
	3	Inhibit time	p8723.2	U16	0	r/w
	4	Reserved	p8723.3	U8	---	r/w
	5	Event timer	p8723.4	U16	0	r/w
1804		Transmit PDO 5 communication parameter				
	0	Largest subindex supported		U8	5	r
	1	COB ID used by PDO	p8724.0	U32	C000 06DF hex	r/w
	2	Transmission type	p8724.1	U8	FE hex	r/w

6.6 Object directories

OD index (hex)	Sub-index (hex)	Object name	SINAMICS parameters	Data type	Predefined connection set	Can be read/written
	3	Inhibit time	p8724.2	U16	0	r/w
	4	Reserved	p8724.3	U8	---	r/w
	5	Event timer	p8724.4	U16	0	r/w
1805		Transmit PDO 6 communication parameter				
	0	Largest subindex supported		U8	5	r
	1	COB ID used by PDO	p8725.0	U32	C000 06DF hex	r/w
	2	Transmission type	p8725.1	U8	FE hex	r/w
	3	Inhibit time	p8725.2	U16	0	r/w
	4	Reserved	p8725.3	U8	---	r/w
	5	Event timer	p8725.4	U16	0	r/w
1806		Transmit PDO 7 communication parameter				
	0	Largest subindex supported		U8	5	r
	1	COB ID used by PDO	p8726.0	U32	C000 06DF hex	r/w
	2	Transmission type	p8726.1	U8	FE hex	r/w
	3	Inhibit time	p8726.2	U16	0	r/w
	4	Reserved	p8726.3	U8	---	r/w
	5	Event timer	p8726.4	U16	0	r/w
1807		Transmit PDO 8 communication parameter				
	0	Largest subindex supported		U8	5	r
	1	COB ID used by PDO	p8727.0	U32	C000 06DF hex	r/w
	2	Transmission type	p8727.1	U8	FE hex	r/w
	3	Inhibit time	p8727.2	U16	0	r/w
	4	Reserved	p8727.3	U8	---	r/w
	5	Event timer	p8727.4	U16	0	r/w

Table 6- 6 TPDO configuration objects - mapping parameters

OD index (hex)	Sub-index (hex)	Object name	SINAMICS parameters	Data type	Predefined connection set	Can be read/written
1A00		Transmit PDO 1 mapping parameter				
	0	Number of mapped application objects in PDO		U8	1	r/w
	1	PDO mapping for the first application object to be mapped	p8730.0	U32	6041 hex	r/w
	2	PDO mapping for the second application object to be mapped	p8730.1	U32	0	r/w
	3	PDO mapping for the third application object to be mapped	p8730.2	U32	0	r/w
	4	PDO mapping for the fourth application object to be mapped	p8730.3	U32	0	r/w
1A01		Transmit PDO 2 mapping parameter				
	0	Number of mapped application objects in PDO		U8	2	r/w
	1	PDO mapping for the first application object to be mapped	p8731.0	U32	6041 hex	r/w
	2	PDO mapping for the second application object to be mapped	p8731.1	U32	6044 hex	r/w
	3	PDO mapping for the third application object to be mapped	p8731.2	U32	0	r/w
	4	PDO mapping for the fourth application object to be mapped	p8731.3	U32	0	r/w
1A02		Transmit PDO 3 mapping parameter				
	0	Number of mapped application objects in PDO		U8	0	r/w
	1	PDO mapping for the first application object to be mapped	p8732.0	U32	0	r/w
	2	PDO mapping for the second application object to be mapped	p8732.1	U32	0	r/w
	3	PDO mapping for the third application object to be mapped	p8732.2	U32	0	r/w
	4	PDO mapping for the fourth application object to be mapped	p8732.3	U32	0	r/w
1A03		Transmit PDO 4 mapping parameter				
	0	Number of mapped application objects in PDO		U8	0	r/w
	1	PDO mapping for the first application object to be mapped	p8733.0	U32	0	r/w
	2	PDO mapping for the second application object to be mapped	p8733.1	U32	0	r/w
	3	PDO mapping for the third application object to be mapped	p8733.2	U32	0	r/w
	4	PDO mapping for the fourth application object to be mapped	p8733.3	U32	0	r/w
1A04		Transmit PDO 5 mapping parameter				
	0	Number of mapped application objects in PDO		U8	0	r

6.6 Object directories

OD index (hex)	Subindex (hex)	Object name	SINAMICS parameters	Data type	Predefined connection set	Can be read/written
	1	PDO mapping for the first application object to be mapped	p8734.0	U32	0	r/w
	2	PDO mapping for the second application object to be mapped	p8734.1	U32	0	r/w
	3	PDO mapping for the third application object to be mapped	p8734.2	U32	0	r/w
	4	PDO mapping for the fourth application object to be mapped	p8734.3	U32	0	r/w
1A05		Transmit PDO 6 mapping parameter				
	0	Number of mapped application objects in PDO		U8	0	r/w
	1	PDO mapping for the first application object to be mapped	p8735.0	U32	0	r/w
	2	PDO mapping for the second application object to be mapped	p8735.1	U32	0	r/w
	3	PDO mapping for the third application object to be mapped	p8735.2	U32	0	r/w
	4	PDO mapping for the fourth application object to be mapped	p8735.3	U32	0	r/w
1A06		Transmit PDO 7 mapping parameter				
	0	Number of mapped application objects in PDO		U8	0	r
	1	PDO mapping for the first application object to be mapped	p8736.0	U32	0	r/w
	2	PDO mapping for the second application object to be mapped	p8736.1	U32	0	r/w
	3	PDO mapping for the third application object to be mapped	p8736.2	U32	0	r/w
	4	PDO mapping for the fourth application object to be mapped	p8736.3	U32	0	r/w
1A07		Transmit PDO 8 mapping parameter				
	0	Number of mapped application objects in PDO		U8	0	r
	1	PDO mapping for the first application object to be mapped	p8737.0	U32	0	r/w
	2	PDO mapping for the second application object to be mapped	p8737.1	U32	0	r/w
	3	PDO mapping for the third application object to be mapped	p8737.2	U32	0	r/w
	4	PDO mapping for the fourth application object to be mapped	p8737.3	U32	0	r/w

6.6.2 Free objects

You can interconnect any process data objects of the receive and transmit buffer using receive and transmit double words.

- Scaling for percentage values:
 - 16-bit (word): 4000 hex \triangleq 100%
 - 32-bit (doubleword) 4000000 hex \triangleq 100%
- Scaling for values referred to units:
 - 16 bit (word): 4000 hex \triangleq value of the corresponding reference parameter for p200x
 - 32-bit (double word) 4000000 hex \triangleq Value of the corresponding reference parameter for p200x

Example:

- For temperature values: 16-bit (word): 4000 hex \triangleq p2006
- For temperature values: 32-bit (doubleword): 4000000 hex \triangleq p2006

The "SINAMICS parameters" column shows the parameter numbers assigned in the inverter. The assignment applies to the case in which an object which is not mapped in any PDO is to be accessed via SDO.

OD index (hex)	Description	Data type per PZD	Default setting	Can be written to-/ read	SINAMICS parameters
5800 ... 580F	16 freely-interconnectable receive process data	I16	0	r/w	r8745[0 ... 15]
5810 ... 581F	16 freely-interconnectable transmit process data	I16	0	r	r8746[0 ... 15]
5820 ... 5827	8 freely-interconnectable receive process data	I32	0	r/w	r8747[0 ... 7]
5828 ... 582F	Reserved				
5830 ... 5837	8 freely-interconnectable transmit process data	I32	0	r	r8748[0 ... 7]
5828 ... 582F	Reserved				

6.6.3 Objects from the CiA 402 drive profile

The following table lists the object directory with the index of the individual objects for the drives. The "SINAMICS parameters" column shows the parameter numbers assigned in the inverter.

OD index (hex)	Sub-index (hex)	Name of the object	SINAMICS parameters	Transmission	Data type	Default setting	Can be read/written
Predefinitions							
67FF		Single device type		SDO	U32		r
Common entries in the object dictionary							
6007		Abort connection option code	p8641	SDO	I16	3	r/w
6502		Supported drive modes		SDO	I32		r
6504		Drive manufacturer		SDO	String	SIEMENS	r
Device control							
6040		Control word	r8795	PDO/SDO	U16	-	r/w
6041		Status word	r8784	PDO/SDO	U16	-	r
605D		Halt option code	p8791	PDO/SDO	I16	-	r/w
6060		Modes of operation	p1300	SDO	I8	-	r/w
6061		Modes of operation display	r8762	SDO	I8	-	r
Factor group							
6094		Velocity encoder factor		SDO	U8	-	r
	01	velocity encoder factor numerator	p8798[1]	SDO	U32	1	r/w
	02	velocity encoder factor denominator	p8798[2]	SDO	U32	1	r/w
Profile velocity mode							
6063		Actual position value	r0482	SDO/PDO	I32	-	r
6069		Velocity sensor actual value	r0061	SDO/PDO	I32	-	r
606B		Velocity demand value	r1170	SDO/PDO	I32	-	r
606C		Velocity actual value Actual velocity	r0063	SDO/PDO	I32	-	r
6083		Profile acceleration	p1082/p1120	SDO	I32	-	r/w
6084		Profile deceleration	p1082/p1121	SDO	I32	0	r/w
6085		Quick stop deceleration	p1082/p1135	SDO	I32	0	r/w
6086		Motion profile type	p1115/p1134	SDO	I32	0	r/w
60FF		Target velocity Set velocity	p1155[0] ¹⁾ p1072 ²⁾	SDO/PDO	I32	0	r/w
Profile Torque Mode ³⁾							
6071		Target torque torque setpoint	r8797	SDO/PDO	I16	-	r/w
6072		Max. torque	p1520	SDO	0	0	
6074		Torque demand value overall torque setpoint	r0079	SDO/PDO	I16	-	r

OD index (hex)	Sub-index (hex)	Name of the object	SINAMICS parameters	Transmission	Data type	Default setting	Can be read/written
6077		Torque actual value	r0080	SDO/PDO	I16	–	r
Velocity mode							
6042		vl target velocity	r8792	SDO/PDO	I16	–	r/w
6043		vl velocity demand	r1170	SDO/PDO	I16	–	r
6044		vl velocity actual value	r0063	SDO/PDO	I16	–	r
6046	0	vl velocity min./max. amount		SDO	U8	–	r
	1	vl velocity min. amount	p1080	SDO	U32	–	r/w
	2	vl velocity max. amount	p1082	SDO	U32	–	r/w
6048	0	vl velocity acceleration		SDO	U8	–	r
	1	Delta speed	p1082	SDO	U32	–	r/w
	2	Delta time	p1120	SDO	U16	–	r/w

1) Without ramp-function generator

2) With ramp-function generator

3) The inverter can process the objects from the Profile Torque Mode. But they cannot be set nor selected in inverters.

6.7 Integrating the inverter into CANopen

Commissioning

Requirement

- Startdrive is installed on the computer used to commission the system.
- The inverter is connected to a CANopen master.
- The EDS (Electronic Data Sheet) is installed on your CANopen master.
- In the basic commissioning you have set the inverter interfaces to the CANopen fieldbus.

This means that the following signals in the inverter are interconnected corresponding to the Predefined Connection Sets:



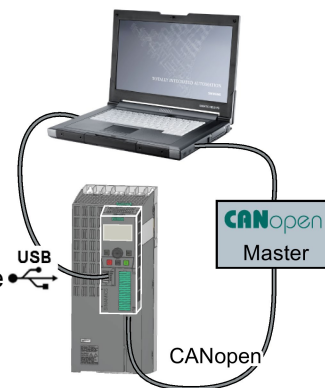

- Speed setpoint and control word
- Speed actual value and status word



You can find the EDS in the Internet at:

EDS (electronic data sheet) (<http://support.automation.siemens.com/WW/view/en/48351511>)



Procedure

1.  Connecting inverter to CAN bus (Page 207)
2. Set the node ID, baud rate and the communication monitoring.
 -  Setting the node ID and baud rate (Page 207)"
 -  Setting the monitoring of the communication (Page 208)"
3. Interconnect additional process data
Set p8744 = 2. You can now interconnect other process data.
 -  Free PDO mapping (Page 184)"
4. Signal interconnection of the links created in free PDO mapping.
 -  Interconnect objects from the receive and transmit buffers (Page 187).
5. Exit commissioning
This is carried out in Startdrive in the commissioning wizard.

You have now commissioned the CANopen interface.

□

More information about configuring the communication:

-  Communication over CANopen (Page 169)
-  Object directories (Page 194).

6.7.1 Connecting inverter to CAN bus

Connect the inverter to the fieldbus via the 9-pin SUB-D pin connector.

The connections of this pin connector are short-circuit proof and isolated. If the inverter forms the first or last slave in the CANopen network, then you must switch-in the bus-terminating resistor.

For additional information, refer to the operating instructions of the Control Unit.

6.7.2 Setting the node ID and baud rate

Node ID

Valid value range: 1 ... 127

You have the following options for setting the node ID:

- Using the address switch on the Control Unit:

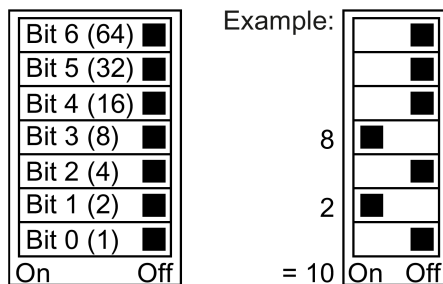

Figure 6-11 Address switch with example for bus address 10

The address switch has priority over the other settings.

- Using Startdrive or an operator panel via parameter p8620 (default setting: p8620 = 126)
It is only possible to change p8620 if the address 0 is set in the address switch.

If you are working with Startdrive, back up the settings so they are not lost if the power fails.

The position of the address switch is available in the operating instructions for the inverter.



Manuals and technical support (Page 232)

Setting the baud rate

You can set the baud rate using parameter p8622. If you are working with Startdrive, back up the settings so they are not lost if the power fails.

Setting range: 10 kbit/s ... 1 Mbit/s. The maximum permissible cable length for 1 Mbit/s is 40 m.

Activating node ID or baud rate

Procedure

To activate the changed node ID or baud rate, proceed as follows:

1. Switch off the inverter power supply.
2. Wait until all LEDs on the inverter are dark.
3. Switch on the inverter power supply again.

Your settings become effective after switching on.

You have now activated the changed settings.

□

6.7.3 Setting the monitoring of the communication

To monitor the communication, use one of the following methods:

- Node guarding / life guarding

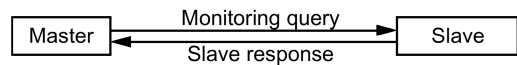

- Heartbeat

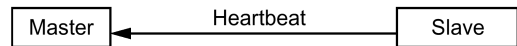

Node guarding / life guarding

Principle of operation

- Node guarding:
Is always active if heartbeat is not activated (p8606 = 0). Node guarding means the master sends monitoring queries to the inverter which then answers.

The inverter does not monitor the communication. Set the responses to a bus failure in the master.

- Life guarding:
is active if you use p8604.0 and p8604.1 to set a lifetime ≠ 0.
Life Guarding means that the inverter monitors the master's monitoring query and reports fault F8700 (A) with fault value 2, if a life guarding protocol (life guarding event) is not received within the lifetime. Set additional responses to a bus failure in the master.

Calculate value for lifetime

Life time = guard time in milliseconds (p8604.0) * life time factor (p8604.1)

Heartbeat

Principle of operation

The slave periodically sends heartbeat messages. Other slaves and the master can monitor this signal. In the master, set the responses for the case that the heartbeat does not come.

Setting value for heartbeat

Set in p8606 the cycle time for the heartbeat in milliseconds.

Inverter behavior with a bus fault

With a bus fault, the CAN master goes to the "Bus OFF" status. In the inverter, set the response to the bus error using parameter p8641. Factory setting: p8641 = 3 (AUS3).

If you have resolved the bus error, then you have the following options to restart communication:

- You switch off the inverter power supply, wait until all of the LEDs on the inverter go dark, and then you switch on the inverter power supply again.

This means that you withdraw the bus state and restart communication.

- You acknowledge the bus error via DI 2 or directly via p3981 and start the communication either
 - Manually by setting p8608[0] = 1. After starting, p8608 is internally set back to 0.
 - Automatically every two seconds. To do this, you must have set p8608[1] to 1 when commissioning.

WARNING

OFF command not effective as a result of a bus fault

When the bus has a fault condition, the higher-level control cannot access the inverter. If, as a response to a bus fault p8641 = 0 (no response) is set, then the motor remains switched-on - even if the higher-level control sends an OFF command to the inverter.

- Configure an additional OFF command via terminals.

6.8 Error diagnostics

Objects to signal and describe errors and operating states

The following options are available to display errors and operating states:

- Display of the operating state using LEDs
- Display of the operating state using the alarm object (Emergency Object)
 - Inverter-specific error list (predefined error field)
 - CANopen error register (error register)

Description of the LED symbols for CANopen

















	LED is bright
	LED flashes slowly
	LED flashes quickly
	LED flashes in the "single flash" mode
	LED flashes in the "double flash" mode
	LED flashes with variable frequency

Table 6- 7 CANopen fieldbus

BF	Explanation
	Data exchange between the inverter and control system is active ("Operational" state)
	Fieldbus is in the "Pre-operational" state
	Fieldbus is in the "Stopped" state
	No fieldbus available
	RDY When LED RDY flashes simultaneously: Firmware update failed
	Alarm - limit reached
	Error event in the higher-level control system (Error Control Event)
	Inverter waits until the power supply is switched off and switched on again after a firmware update
	Incorrect memory card or unsuccessful firmware update
	Firmware update is active

Display of the operating state using the alarm object (Emergency Object)

Error states are displayed using the alarm object (Emergency Object), OV index 1014 in the emergency telegram. It has the following structure:

Byte 0 ... 1	Byte 2	Byte 3 ... 4	Byte 5	Byte 6	Byte 7
CANopen Errorcode	CANopen Error Register	SINAMICS fault number	Drive object (always = 1)	Reserved	Reserved

- Bytes 0 and 1: CANopen error code
- Byte 2: Codes for the CANopen error register
- Byte 5: Number of the drive object. For G120 inverters, this is always = 1

Errors trigger an emergency telegram and cause the drive to shut down.

You can suppress the emergency telegram by setting bit 31 in object 1014 hex to 1.

This means that shutdown is not suppressed, however the fault message is not sent to the master.

Inverter-specific error list (predefined error field)

You can read out the inverter-specific error list using the following objects:

- OV index 1003 hex
- Inverter parameter p8611

It includes the alarms and faults present in the inverter in the CANopen alarm number range 8700-8799.

The errors are listed in the order in which they occur using an error code and additional, device-specific information.

As soon as a fault is acknowledged or an alarm is resolved, they are deleted from the inverter-specific error list.

You acknowledge all of the active inverter errors by setting subindex 0 in the OV index 1003 to 0 or setting p8611[0] = 0.

Table 6- 8 CANopen error code

Error code	Meaning	Explanation
0000 hex	No error present	Successful acknowledgement of all errors or all the alarms are cleared in the display.
1000 hex	CAN Error 1	All other SINAMICS faults/errors
1001 hex	CAN Error 2	All other CANopen alarms in the alarm number range F08700 to F08799
8110 hex	CAN overflow, message lost	CBC: Telegram loss (A(N)08751) [alarm]
8120 hex	CAN Error Passive	CBC: Error number for Error Passive exceeded (A08752) [alarm]
8130 hex	CAN Life Guard Error	CBC: Communications error, alarm value 2 F08700(A) [error/alarm]

CANopen error register (error register)

You can read out the error register using the following objects:

- OV index 1001 hex
- Inverter parameter r8601

It indicates the error in byte 2 of the emergency telegram.

Table 6- 9 CANopen Error Register

Error Register	Meaning	Explanation
Bit 0	Generic error	Set for every alarm that CAN identifies.
Bit 4	Communication error	Is set for CAN communication alarms (alarms in the range 08700 ... 08799).
Bit 7	Manufacturer error	Is set for all alarms outside the range 08700 ... 08799.

Response in the case of an error

For a CAN communication error, e.g. too many telegram failures, the inverter outputs fault F(A)08700(2).

For further information, please refer to the List Manual of your inverter.



Overview of the manuals (Page 232)).

You set the response of the CAN node in p8609.

- p8609 = 0 Pre-operational
- p8609 = 1 No change (factory setting)
- p8609 = 2 Stopped

You set the inverter response in p8641:

- p8641 = 0 No reaction (factory setting)
- p8641 = 1 OFF1
- p8641 = 2 OFF2
- p8641 = 3 OFF3

6.9 CAN bus sampling time

The CAN bus sampling time is 4 ms. The inverter can send and receive telegrams within this time frame.

Receive telegrams cycle time

- For cyclic receive telegrams, the cycle time must be greater than twice the sampling time. Telegrams could be lost if the cycle time is any less than this. In this case, warning A08751 appears.
- With receive telegrams for which data does not change faster than twice the sampling time, it is possible to set a cycle time shorter than twice the sampling time if your application permits telegrams to be lost in the process.

An A08751 warning can be avoided by changing the message type to "No message" via parameters p2118 and p2119.

Communication via AS-i - only for G110M

General information

The inverter operates based on the extended AS-i specification V3.0.

The signaling is made as Manchester-coded current pulses superimposed on the 28 V supply. Decouple the 28 V supply with inductances so that the receivers can decouple the transferred messages.

The Control Unit power consumption is approx. 90 mA provided you do not use any digital or analog inputs. When you use digital and analog inputs, the power requirement can be as high as 300 mA.

The inverter supports the Single Slave and Dual Slave modes.

In Single Slave mode, the inverter has an address in the AS-i network over which four bits are transferred. In Dual Slave mode, each inverter has two AS-i addresses over each of which four bits are transferred.

In the Single Slave mode, communication is realized in accordance with protocol 7.F.E. In the Dual Slave mode, communication is realized in accordance with protocols 7.A.5 and 7.A.E.

Default settings for commissioning

To configure the communication of the inverter via AS-i, the following possibilities are available for commissioning the inverter:

- Default setting 30 - Single Slave mode, standard addressing
Single Slave mode with specification of a fixed frequency via the control
- Default setting 31 - Dual Slave mode with fixed setpoints
Dual Slave mode with specification of a fixed frequency via the control
- Default setting 32 - Single Slave mode, modified addressing:
Single Slave mode with "ON clockwise / OFF1", "ON counter-clockwise / OFF1", speed setpoint via CDS0 or CDS1
- Default setting 34 - Dual Slave mode with "ON/OFF1", "OFF2"
Dual Slave mode with "ON/OFF1", "OFF2", speed setpoint via control

Details about the default settings are provided in the operating instructions of your inverter.



Overview of the manuals (Page 232)

Connection

The following table shows the AS-i plug assignment. Further connection information is contained in the AS-Interface system manual.



 Overview of the manuals (Page 232)

Table 7- 1 Pin assignment

X03 AS-i (M12)	Pin	Function	Description
	1	AS-i +	AS-i plus signal
	2	0 V	Reference potential for terminal 4
	3	AS-i -	AS-i minus signal
	4	24 V	24 V auxiliary voltage
	5	Not assigned	

7.1 Setting the address

As factory setting, all AS-i slaves have address 0. Slaves with address 0 are not included in the communication.

The addresses must be unique, although they can be mixed as required.

You have the following options when making the address assignment:

- Automatic addressing via the AS-i master
- Addressing via the addressing device
- Addressing via parameters

Before you set the address, you must specify whether the inverter is integrated as Single Slave or Dual Slave in the AS-i network.

- p2013 = 0: Single Slave (factory setting)
- p2013 = 2: Dual Slave

If for the commissioning you select the default setting 30 or 32 (Single Slave), or 31 or 34 (Dual Slave), p2013 is assigned the appropriate value.

Note

Changes made to p2012 and p2013

Changes made to the p2012 and p2013 parameters take effect immediately after the change.

If you work with Startdrive, you must back up the changes so they are not lost when the system is switched off and on again.

Automatic addressing via the AS-i master

Single Slave

For automatic addressing, the address is specified by the AS-i master. For a Single Slave, the master checks which slave has address 0 and assigns it the next free address. This address is also written to parameter p2012. If more than one slave has address 0, an automatic addressing is not possible.

Dual Slave

For automatic addressing, the address is specified by the AS-i master. If both slaves have address 0, the second slave is hidden and the control assigns a valid address for slave 1.

Slave 2 then becomes visible with address 0 and can be addressed.

Automatic addressing is not always possible for older AS-i masters. In this case, use the manual addressing and set the address from an addressing device, via Startdrive or from an operator panel on the inverter.

Further information is contained in the AS-Interface system manual, Section "Setting the AS-i address"



Overview of the manuals (Page 232)

7.1 Setting the address

Addressing via the addressing device (e.g. 3RK1904-2AB02)

Addressing via the addressing device is made offline.

Further information is contained in the AS-Interface system manual, Section "Setting the AS-i address"



Overview of the manuals (Page 232)

Addressing via parameters

The address assignment is made with the p2012[0] and p2012[1] parameters.

If you assign the address via Startdrive, you must back up the settings so that they are not lost if the power fails.

- Address range for Single Slave inverter, profile 7.F.E
 - p2012[1]: 0 ... 31, range for the A address, 0A ... 31A
 - Address range for Dual Slave inverter, profile 7.A.5 or 7.A.E
 - p2012[0]: 0 ... 31, 33 ... 63 for slave 1:
 - p2012[1]: 0 ... 31, 33 ... 63 for slave 2:
- with
- 0 ... 31 range for the A address, 0A ... 31A
 - 33 ... 63 range for B address, 1B ... 31B

7.2 Single Slave mode

In Single Slave mode, four bits are available for the communication between the AS-i master and the inverter. The four bits are used to transfer process data. In parallel, the control can start a diagnostic request via AS-i.P0.

The following default settings are available; both work with profile 7.F.E.

- Default setting 30: Standard Single Slave mode
- Default setting 32: Modified Single Slave mode

Default setting 30: Standard Single Slave mode

In standard addressing, the control specifies the speed setpoint via the motor control bits (AS-i.DO0 ... AS-i.DO3).

Control -> inverter

- AS-i.DO0 -> p1020 = 2093.0 Fixed speed bit 0
- AS-i.DO1 -> p1021 = 2093.1 Fixed speed bit 1
- AS-i.DO2 -> p1022 = 2093.2 Fixed speed bit 2
- AS-i.DO3 -> p1023 = 2093.3 Fixed speed bit 3



Table 7-2 Fixed speeds via the motor control bits (Page 224).

Inverter -> control

If the control specifies the speed setpoint, the inverter replies:

- p2080[0] = 53.13 -> AS-i.DI0 Operational enable for PLC
- p2080[1] = 899.11 -> AS-i.DI1 Pulses enabled
- p2080[2] = 722.0 -> AS-i.DI2 State DI0
- p2080[3] = 722.1 -> AS-i.DI3 State DI1

If the control sends a diagnostic request via AS-i.P0, the inverter replies with the currently pending fault or alarm messages.



Table 7-5 Alarm and fault messages via RP0 ... RP3 from the inverter to the AS-i master (Page 225).

Default setting 32: Modified Single Slave mode

In Single Slave mode with modified addressing the control specifies the following:

Control -> inverter

- AS-i.DO0 -> p3330.0 = 2093.0 ON clockwise / OFF 1
- AS-i.DO1 -> p3331.0 = 2093.1 ON counter-clockwise / OFF 1
- AS-i.DO2 -> p0810 = 2093.2 Speed via potentiometer or AI0
- AS-i.DO3 -> p2104 = 2093.3 Acknowledge errors with a positive edge
p0852 = 2093.3 Operating enable, if p2093.3 = 1

Inverter -> control

The inverter sends as response:

- p2080[0] = 899.0 -> AS-i.DI0 Ready to switch on
- p2080[1] = 807.0 -> AS-i.DI1 Control priority
- p2080[2] = 722.0 -> AS-i.DI2 State DI0
- p2080[3] = 722.1 -> AS-i.DI3 State DI1

If an alarm or fault is pending in the inverter, it sends a warning or fault message.

 Table 7-5 Alarm and fault messages via RP0 ... RP3 from the inverter to the AS-i master (Page 225).

Scaling factors for the speed

The scaling factor is specified via AS-i.P0 ... AS-i.P3. A diagnostic request is also performed when AS-i.P0 is sent.

This means, if the control specifies a scaling factor and an alarm or fault is pending in the inverter, it sends the current alarm or fault messages and accepts simultaneously the sent value consisting of AS-i.P0 ... AS-i.P3 as new scaling factor.

- AS-i.P0 Scaling factor bit 0
- AS-i.P1 Scaling factor bit 1
- AS-i.P2 Scaling factor bit 2
- AS-i.P3 Scaling factor bit 3

 Table 7-3 Scaling of the speed setpoint via AS-i.P0 ... AS-i.P3 (Page 224).

7.3 Dual Slave mode

In Dual Slave mode, eight bits are available for the communication between the AS-i master and the inverter. The eight bits are used to transfer process data. In parallel, the control can start a diagnostic request via AS-i.P0.

The following default settings are possible:

- Default setting 31: Dual Slave mode with fixed setpoints
- Default setting 34: Dual Slave mode with setpoint via AS-i field bus

Default setting 31: Dual Slave mode with fixed setpoints

The control accesses the two slaves of the inverter each via four bits.

Via slave 2, in accordance with profile 7.A.E, the control specifies the speed setpoint via the motor control bits (AS-i.DO0 ... AS-i.DO2).

Via slave 1, the control sends data in cyclical or acyclical mode, in accordance with profile 7.A.5.

The control requires one bit per slave in order to specify the slave.

Default setting 31, slave 2 with profile 7.A.E: Control -> inverter

- AS-i.DO0 -> p1020.0 = 2093.0 Fixed speed bit 0
- AS-i.DO1 -> p1021.0 = 2093.1 Fixed speed bit 1
- AS-i.DO2 -> p1022.0 = 2093.2 Fixed speed bit 2
- AS-i.DO3 -> Select slave A or slave B, interconnected internally



Table 7-4 Fixed speeds via the motor control bits and response in the inverter (Page 225).

If the control specifies the speed setpoint, the inverter replies:

Default setting 31, slave 2 with profile 7.A.E: Inverter -> control

- p2080[0] = 53.13 PLC ready to switch on -> AS-i.DI0
- p2080[1] = 899.11 Pulses enabled -> AS-i.DI1
- p2080[2] = 722.0 State DI0 -> AS-i.DI2
- p2080[3] = 722.1 State DI1 -> AS-i.DI3

If the control sends a diagnostic request via AS-i.P0, the inverter replies with the currently pending fault or alarm messages.



Table 7-5 Alarm and fault messages via RP0 ... RP3 from the inverter to the AS-i master (Page 225).

7.4 Assignment tables

Fixed speeds - Single Slave

Table 7- 2 Fixed speeds via the motor control bits

AS-i.DO3	AS-i.DO2	AS-i.DO1	AS-i.DO0	Response in the inverter
0	0	0	0	OFF1
0	0	0	1	On + fixed speed 1 (factory setting: 1500 rpm)
0	0	1	0	On + fixed speed 2 (factory setting: -1500 rpm)
0	0	1	1	On + fixed speed 3 (factory setting: 300 rpm)
0	1	0	0	On + fixed speed 4 (factory setting: 450 rpm)
0	1	0	1	On + fixed speed 5 (factory setting: 600 rpm)
0	1	1	0	On + fixed speed 6 (factory setting: 750 rpm)
0	1	1	1	On + fixed speed 7 (factory setting: 900 rpm)
1	0	0	0	On + fixed speed 8 (factory setting: 1050 rpm)
1	0	0	1	On + fixed speed 9 (factory setting: 1200 rpm)
1	0	1	0	On + fixed speed 10 (factory setting: 1350 rpm)
1	0	1	1	On + fixed speed 11 (factory setting: 1500 rpm)
1	1	0	0	On + fixed speed 12 (factory setting: 1650 rpm)
1	1	0	1	On + fixed speed 13 (factory setting: 1800 rpm)
1	1	1	0	On + fixed speed 14 (factory setting: 1950 rpm)
1	1	1	1	Acknowledge fault or OFF2

Modified addressing - scaling factors

Table 7- 3 Scaling of the speed setpoint via AS-i.P0 ... AS-i.P3

AS-i.P3	AS-i.P2	AS-i.P1	AS-i.P0	Scaling factor	Frequency (Hz)
1	1	1	1	1	50
1	1	1	0	0.9	45
1	1	0	1	0.8	40
1	1	0	0	0.7	35
1	0	1	1	0.6	30
1	0	1	0	0.5	25
1	0	0	1	0.45	22.5
1	0	0	0	0.4	20
0	1	1	1	0.35	17.5
0	1	1	0	0.3	15
0	1	0	1	0.25	12.5
0	1	0	0	0.2	10
0	0	1	1	0.15	7.5
0	0	1	0	0.1	5
0	0	0	1	0.07	3.5
0	0	0	0	0.05	2.5

Fixed speeds - Dual Slave

Table 7- 4 Fixed speeds via the motor control bits and response in the inverter

AS-i.DO2	AS-i.DO1	AS-i.DO0	Response in the inverter
0	0	0	OFF1
0	0	1	On + fixed speed 1 (factory setting: 1500 rpm)
0	1	0	On + fixed speed 2 (factory setting: -1500 rpm)
0	1	1	On + fixed speed 3 (factory setting: 300 rpm)
1	0	0	On + fixed speed 4 (factory setting: 450 rpm)
1	0	1	On + fixed speed 5 (factory setting: 600 rpm)
1	1	0	On + fixed speed 6 (factory setting: 750 rpm)
1	1	1	Acknowledge fault or OFF2

Alarm and fault messages

Table 7- 5 Alarm and fault messages via RP0 ... RP3 from the inverter to the AS-i master

RP3	RP2	RP1	RP0	AS-i.P0 = 0 -> alarm messages	AS-i.P0 = 1 -> faults
0	0	0	0	No alarm	No fault
0	0	0	1	not used	Overtemperature, F00004, F00006
0	0	1	0	not used	not used
0	0	1	1	No load (A07929)	not used
0	1	0	0	Overtemperature (A07400, A07404, A30502)	I ² t overload (F30005, F07936)
0	1	0	1	Overvoltage (A07400, A07404, A30502)	Equipment malfunction (F30009, F01000, F01001, F01002, F01005, F01015, F01018, F01029, F01000-F01300)
0	1	1	0	not used	not used
0	1	1	1	Undervoltage (A30041, A07402, A07403, A30016)	Motor-PTC sensor malfunction (F07011, F07016)
1	0	0	0	I ² t overload (A08705)	Overvoltage (F30002, F30011)
1	0	0	1	not used	not used
1	0	1	1	not used	Undervoltage (F00003, F30040, F07802)
1	1	0	0	not used	Short-circuit at the output (F30001, F30017, F30021, F07801, F07808, F07900, F30017, F07807)
1	1	0	1	Motor phase loss	Motor phase loss (F30015, F07902)
1	1	1	0	not used	Safety fault (F016xx)
1	1	1	1	Other alarms	Other faults

7.5 Cyclic and acyclic communication via CTT2

Via CTT2 (Combined Transaction Type 2), both cyclical and acyclical communication is performed via AS-i. Because only one channel is available (AS-i.DO1 master -> slave or AS-i.DI3 slave -> master), a concurrent cyclical and acyclical data exchange is not possible.

The communication type (cyclical or acyclical) is always coded in the first byte in accordance with the following table.

Table 7- 6 CTT2 commands

Code (hex)	Explanation/meaning	Followed by
Cyclic communication		
	Access to analog values via DS140 ... DS147. See CP 343-2 / CP 343-2 P AS-Interface master (http://support.automation.siemens.com/WW/view/en/5581657), Chapter 4	4 bytes: PWE1, PWE2
		4 bytes: PWE1, PWE2
Acyclic communication - standard		
10 hex	Read request: Master -> slave	2 bytes: Index, length
50 hex	Read request OK: Slave -> master	Index, data
90 hex	Read request failed: Slave -> master	1 byte: Standard error code (3 hex)
11 hex	Write request: Master -> slave	Index, length, data
51 hex	Write request OK: Slave -> master	
91 hex	Write request failed: Slave -> master	1 byte: Standard error code (3 hex)
Acyclic communication - manufacturer-specific		
12 hex	Read request: Master -> slave	Index, length
52 hex	Read request OK: Slave -> master	Data
92 hex	Read request failed: Slave -> master	Fault object
13 hex	Write request: Master -> slave	Index, length, data
53 hex	Write request OK: Slave -> master	
93 hex	Write request failed: Slave -> master	Fault object
1D hex	Exchange request: Master -> slave	Index, read length, write length, write data
5D hex	Exchange request OK: Slave -> master	PKE, index, n-2 data
9D hex	Exchange request faulty: Slave -> master	Fault object

If an acyclical request cannot be executed by the inverter, it replies with one of the following error messages.

Error message	Meaning
0	No fault
1	Invalid index
2	Incorrect length
3	Request not implemented
4	Busy (the request could not be processed completely within the time window, retry later)
5	Last acyclical request was not confirmed
6	Invalid subindex
7	"Selective read request" command missing

7.5.1 Cyclic communication

Inverter -> master

The inverter cyclically transfers the data from p2051[1] and p2051[2] in four bytes to the master. You can process these four bytes in the control as for analog data. Refer to the documentation for the AS-i master for detailed information about access to analog data.

If you selected default setting 31 or 34 during the commissioning, the two indexes are interconnected as follows:

- p2051[1] = 63: Smoothed actual speed value
- p2051[2] = 27: Absolute smoothed actual current value

The values for transfer are normalized in accordance with the Profidrive N2 data type. Using p2051[1] and p2051[2] you can interconnect any other or connector parameters and transfer to the control.

Master -> inverter

The master transfers the data in the "Combined Transaction Type 2" (CTT2) to the inverter and writes it to r2050[1] and r2050[2].

To process these values in the inverter, you must appropriately interconnect r2050[1] and r2050[2] in the inverter. This means, when the control sends the speed setpoint, you must interconnect parameter p1070 (source for the main setpoint) with r2050 as follows:
p1070[0] = 2050[1]

Note

Internal interconnection with default setting 34

If, when commissioning, you select "Default setting 34", then the main setpoint is internally interconnected with r2050[1].

Once a setpoint has been transferred completely, the setpoint present in the control will be transferred as next setpoint. Any setpoint changes made during the transfer are not considered.

7.5.2 Acyclic communication - standard

This type of acyclical communication supports the ID read request and the diagnostic read request. All other requests receive the "request not implemented" message response.

- ID request:
 - Master -> slave

10 hex	00 hex	nn hex
--------	--------	--------
 - Slave -> master

50 hex	00 hex	Manufacturer's ID	Product ID	BB hex
--------	--------	-------------------	------------	--------
- Diagnostic request:
 - Master -> slave

10 hex	01 hex	nn hex
--------	--------	--------
 - Slave -> master no error

50 hex	01 hex	00 hex
--------	--------	--------

;
 - Slave -> master general error

50 hex	01 hex	99 hex
--------	--------	--------

The following response is issued for all other write or read requests:

- Read requests

90 hex	03 hex
--------	--------
- Write requests

91 hex	03 hex
--------	--------

7.5.3 Acyclic communication - manufacturer-specific

The manufacturer-specific acyclical communication is performed via data record 47 in PIV format. The PIV format structure is identical with that for the USS parameter channel.



USS parameter channel (Page 116).

To reduce the transfer volume, there is not only the "normal" "data exchange" PIV mechanism, but also the "Read data" and "Write data" commands.

- Data exchange:
 - Control -> inverter request
 - Inverter -> control response
- Read data:

The inverter sends a read command, and the data of the last exchange request or write request is transferred from the inverter to the control.
- Write data

Write OK: -> 53 hex.

Because the PIV transfer protocol specifies the transfer direction independently, all parameters can be transferred as data exchange request/response. Requests for reading and writing data are included primarily to reduce the transferred data volume for the repeated reading or writing of parameters.

Data exchange

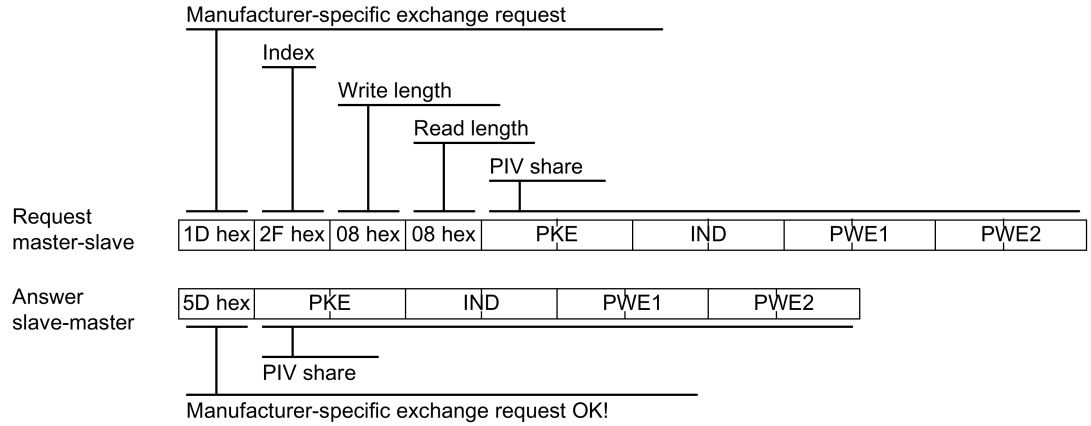

Reading data

The data for the last write or exchange request is read

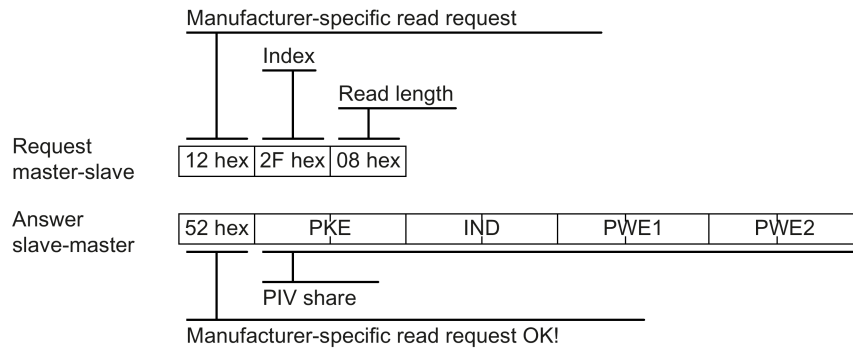

Writing data

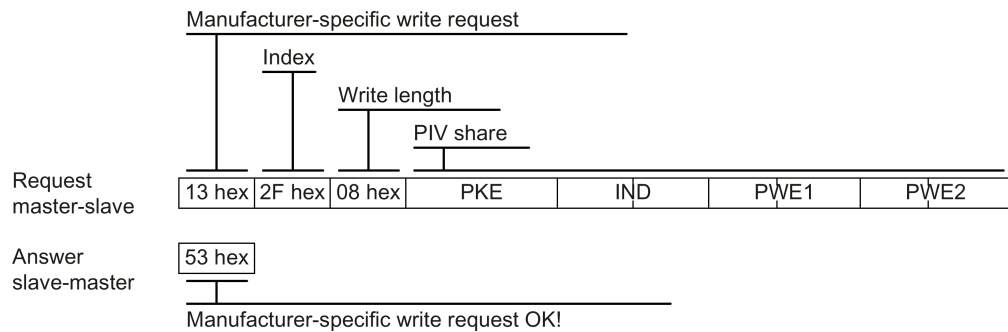

In the event of a fault, the inverter sends the following telegram as response to the master:

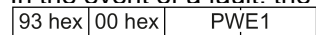

Value for PWE: Fault table from USS parameter channel (Page 116).

Appendix

A.1 Application examples for communication with STEP7

Application examples for communication with STEP 7 can be found in the following manual:



















"Fieldbuses" function manual, edition 09/2017





































<https://support.industry.siemens.com/cs/ww/en/view/109751350>



















A.2 Manuals and technical support

A.2.1 Overview of the manuals

You can find manuals here with additional information for downloading

-  CU250S-2 operating instructions
(<https://support.industry.siemens.com/cs/ww/en/view/109482997>)
Installing, commissioning and maintaining the inverter. Advanced commissioning

-  CU240B/E-2 operating instructions
(<https://support.industry.siemens.com/cs/ww/en/view/109482994>)
Installing, commissioning and maintaining the inverter. Advanced commissioning

-  CU230P-2 operating instructions
(<https://support.industry.siemens.com/cs/ww/en/view/109751316>)
Installing, commissioning and maintaining the inverter. Advanced commissioning

-  SINAMICS G120C operating instructions.
(<https://support.industry.siemens.com/cs/ww/en/view/109482993>)
Installing, commissioning and maintaining the inverter. Advanced commissioning

-  SINAMICS G110M operating instructions
(<https://support.industry.siemens.com/cs/ww/en/view/109478193>)
Installing, commissioning and maintaining the inverter. Advanced commissioning

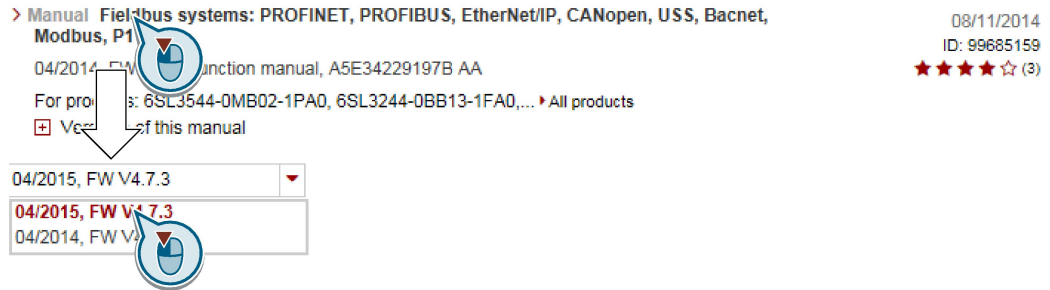
-  Operating instructions SINAMICS G120D with CU240D-2
(<https://support.industry.siemens.com/cs/ww/en/view/109477366>)
Installing, commissioning and maintaining the inverter. Advanced commissioning

-  Operating instructions SINAMICS G120D with CU250D-2
(<https://support.industry.siemens.com/cs/ww/en/view/109477365>)
Installing, commissioning and maintaining the inverter. Advanced commissioning

-  SIMATIC ET200proFC-2 operating instructions
(<https://support.industry.siemens.com/cs/ww/en/view/109478246>)
Installing, commissioning and maintaining the inverter. Advanced commissioning

-  "Safety Integrated" function manual
(<https://support.industry.siemens.com/cs/ww/ene/view/109751320>)
Configuring PROFIsafe.
Installing, commissioning and operating fail-safe functions of the inverter.
  
-  "Fieldbus" function manual
(<https://support.industry.siemens.com/cs/ww/en/view/109751350>)
Configuring fieldbuses (this manual)
  
-  "Basic positioner" function manual
(<https://support.industry.siemens.com/cs/ww/en/view/109477922>)
Commissioning the basic positioner
  
-  CU250S-2 List Manual
(<https://support.industry.siemens.com/cs/ww/en/view/109482981>)
List of all parameters, alarms and faults, graphic function diagrams.
  
-  CU240B/E-2 List Manual
(<https://support.industry.siemens.com/cs/ww/en/view/109482961>)
List of all parameters, alarms and faults, graphic function diagrams.
  
-  CU230P-2 List Manual
(<https://support.industry.siemens.com/cs/ww/en/view/109751313>)
List of all parameters, alarms and faults, graphic function diagrams.
  
-  List manual SINAMICS G120D
(<https://support.industry.siemens.com/cs/ww/en/view/109477255>)
List of all parameters, alarms and faults, graphic function diagrams.
  
-  SINAMICS G120C List Manual
(<https://support.industry.siemens.com/cs/ww/en/view/109482977>)
List of all parameters, alarms and faults, graphic function diagrams.
  
-  SINAMICS G110M List Manual
(<https://support.industry.siemens.com/cs/ww/en/view/109478707>)
List of all parameters, alarms and faults, graphic function diagrams.
  

-  SIMATIC ET 200pro FC-2 List Manual
(<https://support.industry.siemens.com/cs/ww/en/view/109478711>)
List of all parameters, alarms and faults, graphic function diagrams.
  
-  SIMATIC ET 200pro operating instructions
(<https://support.industry.siemens.com/cs/ww/en/view/21210852>)
Distributed ET 200pro I/O system
      
-  SIMATIC ET 200pro motor starters manual
(<https://support.industry.siemens.com/cs/ww/en/view/22332388>)
ET 200pro motor starters
  
-  AS-Interface system manual
(<https://support.industry.siemens.com/cs/ww/en/view/26250840>)
 

Finding the most recent edition of a manual

If there are multiple editions of a manual, select the latest edition:



Configuring a manual

Further information about the configurability of manuals is available in the Internet:

MyDocumentationManager
(<https://www.industry.siemens.com/topics/global/en/planning-efficiency/documentation/Pages/default.aspx>).

Select "Display and configure" and add the manual to your "mySupport-documentation":

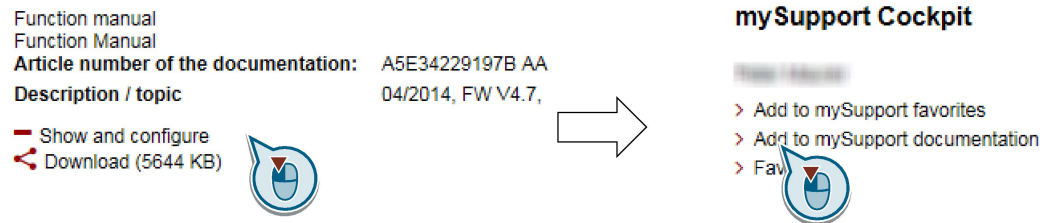

Not all manuals can be configured.

The configured manual can be exported in RTF, PDF or XML format.

A.2.2 Configuring support

Catalog

Ordering data and technical information for SINAMICS G inverters.



Catalogs for download or online catalog (Industry Mall):

 Everything about SINAMICS G120 (www.siemens.com/sinamics-g120)

SIZER

The configuration tool for SINAMICS, MICROMASTER and DYNAVERT T drives, motor starters, as well as SINUMERIK, SIMOTION controllers and SIMATIC technology



 SIZER on DVD:

Article number: 6SL3070-0AA00-0AG0

 Download SIZER (<https://support.industry.siemens.com/cs/ww/en/view/54992004>)

EMC (electromagnetic compatibility) technical overview

Standards and guidelines, EMC-compliant control cabinet design



 EMC overview (<https://support.industry.siemens.com/cs/ww/en/view/103704610>)

EMC Guidelines configuration manual

EMC-compliant control cabinet design, potential equalization and cable routing



 EMC installation guideline
(<http://support.automation.siemens.com/WW/view/en/60612658>)

Safety Integrated for novices technical overview

Application examples for SINAMICS G drives with Safety Integrated



 Safety Integrated for novices
(<https://support.industry.siemens.com/cs/ww/en/view/80561520>)

A.2.3 Product Support

You can find additional information about the product on the Internet:



Product support (<https://support.industry.siemens.com/cs/ww/en/>)

This URL provides the following:

- Up-to-date product information (product announcements)
- FAQs
- Downloads
- The Newsletter contains the latest information on the products you use.
- The Knowledge Manager (Intelligent Search) helps you find the documents you need.
- Users and specialists from around the world share their experience and knowledge in the Forum.
- You can find your local representative for Automation & Drives via our contact database under "Contact & Partner".
- Information about local service, repair, spare parts and much more can be found under "Services".

Index

A

- AC/DC drive profile, 87
- Acyclic communication, 42
- Application example, 40, 75, 75, 145
 - Reading and writing parameters cyclically via PROFIBUS, 40

C

- CAN
 - COB, 170
 - COB ID, 171
 - Device profile, 170
 - EMCY, 170
 - NMT, 170
 - SDO, 170
 - SYNC, 170
- CANopen communication profile, 170
- Catalog, 236
- Checklist
 - PROFINET, 63, 85
- COB, 170
- COB ID, 171
- Communication
 - Acyclic, 42
 - Cyclically, 17
- Configuring support, 236
- Control word
 - Control word 1, 22
 - Control word 2, 25
 - Control word 3, 26
- Control word 2 (STW2), 25
- Control word 3 (STW3), 26
- Cyclic communication, 20

D

- Data set 47 (DS), 42
- DC braking, 26
- Device profile, 170
- Direct data exchange, 41
- Drive-independent communication objects, 194
- DS 47, 42

E

- EMCY, 170
- Ethernet/IP, 81

F

- Function Manual, 232

G

- GSD (Generic Station Description), 76
- GSDML (Generic Station Description Markup Language), 63

H

- Hotline, 237

I

- IND (page index), 38, 119
- Industry Mall, 236

L

- List Manual, 232

M

- Maximum cable length
 - Modbus, 125
 - PROFIBUS, 76
 - PROFINET, 62
 - USS, 111
- MELD_NAMUR (fault word according to the VIK-Namur definition), 28

N

- Network management (NMT service), 172
- NMT, 170

O

Operating instruction, 3
Operating instructions, 232

P

Page index, 38, 119
Parameter channel, 35, 116
 IND, 38, 119
Parameter index, 38, 119
Parameter number, 38
Parameter value, 42
PDO, 179
Procedure, 3
PROFIBUS, 75
PROFenergy, 65
Pulse cancelation, 22
Pulse enable, 22

Q

Questions, 237

R

RS485 interface, 110

S

SDO, 170, 175
SDO services, 175
SIZER, 236
Status word
 Status word 1, 23
 Status word 2, 25
 Status word 3, 27
Status word 1 (ZSW2), 25
STW1 (control word 1), 22
Subindex, 38, 119
Support, 237
Switching on inhibited, 22
Symbols, 3
SYNC, 170

T

Technology controller, 26
Telegram
 Extending, 33

U

USS (universal serial interface), 111, 116

Z

ZSW1 (status word 1), 23
ZSW3 (status word 3), 27

Further information

SINAMICS converters:

www.siemens.com/sinamics

Safety Integrated

www.siemens.com/safety-integrated

PROFINET

www.siemens.com/profinet

Siemens AG

Digital Factory

Motion Control

Postfach 3180

91050 ERLANGEN

Germany

Scan the QR code for
additional
information about
SINAMICS G120.

