

de Montageanleitung
en Mounting instructions
fr Instructions de montage
sv Monteringsinstruktion
nl Montage-aanwijzing
it Istruzioni di montaggio
fi Asennusohje
es Instrucciones de montaje
da Monteringsvejledning
zh 安装指导

Drehantrieb
Rotary-type actuator
Servo-moteur à action angulaire
Spjällställdon med vridande rörelse
Luchtklepservomotor voor rot. aandrijving
Servocomando rotativo per serrande
Kiertoliikkeinen ilmapeltien toimimoottori
Actuador de acción rotativa
Motor for drejebevægelse
旋转型执行器

GSD..41.9A

A **de** Lieferumfang
en Deliverables
fr Contenu
sv Leverans

nl Leveringsomvang
it Contenuto
fi Toimituslaajuus
es Contenido

da Leverancens omfang
zh 设备构件

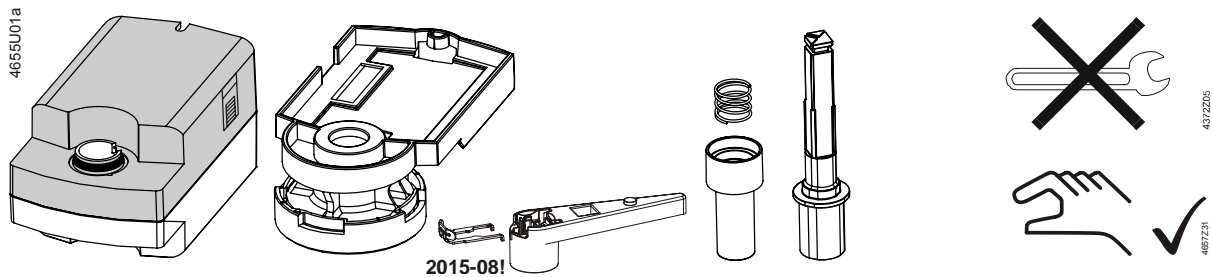

B **de** Hinweise / Warnungen
en Notes / Warnings
fr Indications / Mise en garde
sv Hänvisningar / Varningar

nl Aanwijzingen / Waarschuwingen
it Messa in servizio / Indicazioni
fi Huomauksia / Varoituksia
es Indicaciones / Consejos

da Bemærkninger / Advarsler
zh 提示 / 警告

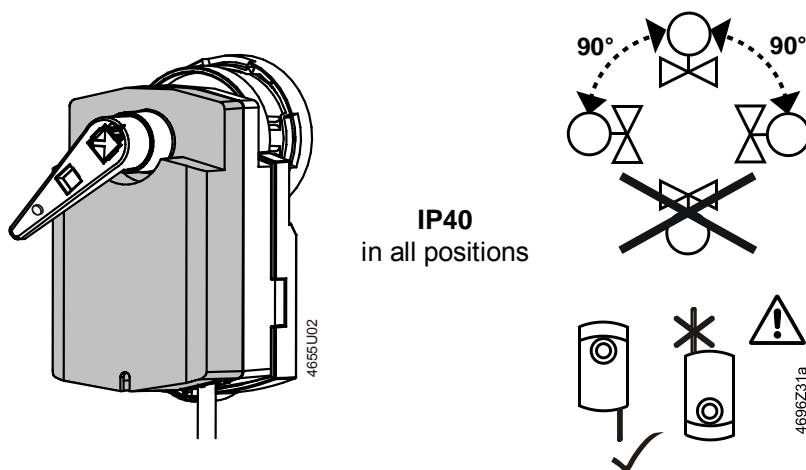



de

Diese Anleitung ist beim Antrieb oder in der Anlagendokumentation aufzubewahren!

 Dieses Symbol weist auf Gefahren und Maßnahmen zum Schutz von Personen und Sachen hin:

- Antriebe für AC 230 V dürfen nur durch autorisiertes Personal angeschlossen werden.
- Die Anschlusskabel des Antriebs dürfen nicht im Wasser liegen.
- Das Anschlusskabel darf weder am Ventilkörper noch an den Rohren befestigt werden.

 Gerät der Schutzklasse II (Schutzisolierung)

 Gerät der Schutzklasse III (Schutzisolierung)

 **Achtung!** Der Stellantrieb darf nicht geöffnet werden

Verdrahtung und Inbetriebnahme

Siehe in den anlagenspezifischen Unterlagen und im Datenblatt N4605 zum Antrieb.

sv

Denna instruktion skall förvaras tillsammans med ställdonet eller anläggningsdokumentationen!

 Denna symbol gäller riskfaktorer samt åtgärder för att undvika person- och materialskador.

- Ställdon med AC 230 V får anslutas endast av behörig personal.
- Ställdonets anslutningskabel får inte ligga i vatten.
- Fäst ej anslutningskabeln direkt på röret eller kulventilen.

 Apparat i isolerclass II (skyddsisolering)

 Apparat i isolerclass III (skyddsisolering)

 **OBS!** Ställdonet får inte öppnas.

Elektrisk inkoppling och igångkörning

Se anläggnings-specifika underlag och i „datablad N4605“ för ställdonet.

fi

Tätä ohjetta tulee säilyttää toimimootorin läheisyydessä tai yhdessä laitosdokumenttien kanssa!

 Tämä symboli viittaa vaaraan ja toimenpiteisiin, joita tarvitaan henkilö- ja aineellisten vahinkojen välttämiseksi:

- Ainoastaan valtuutetut ammattihenkilöt saavat liittää 230 VAC:n toimimootoreita.
- Toimimootorin liitäntäkaapelit eivät saa kastua tai muuten altistua vedelle.
- Älä kiinnitä kytkentäjohtoa putkistoon tai palloventtiiliin

 Suojausluokan II laite (suoraerotus)

 Suojausluokan III laite (suojaerotus)

 **Huomio!** Toimimootoria ei saa avata.

Johdotus ja käyttöönotto

Katso laitoskohtaiset dokumentit ja tekninen esite N4605.

en

Store these instructions together with the actuator or with the plant documentation!

 This symbol denotes dangers and measures to avoid personal injury and property damage:

- Only authorized personnel may connect actuators for AC 230 V.
- Do not expose the actuator's connecting cables to water or lay the cables in water.
- Do not attach the connecting cable to the piping or the ball valve.

 Device of protection class II (protective insulation)

 Device of protection class III (protective insulation)

 **Warning!** Do not open the actuator.

Wiring and commissioning

Refer to the actuator's commissioning instructions and datasheet N4605.

nl

Deze handleiding moet bij de servomotor, of met de documentatie van de installatie worden bewaard!

 Dit symbool wijst op gevaar en maatregelen ter bescherming van personen en materiaal:

- AC 230 V aandrijvingen mogen alleen door bevoegd personeel worden aangesloten.
- De aansluitkabel van de aandrijving mag niet in het water liggen.
- Aansluitkabel niet bevestigen aan afsluiterhuis of leidingen.

 Apparaat van beschermingsklasse II (beschermings isolatie)

 Apparaat van beschermingsklasse III (beschermings isolatie)

 **Opgelet!** De servomotor mag niet worden geopend.

Bekabeling en inbedrijfstelling

Raadpleeg de installatie-documentatie en "Apparatenblad" N4605 van de servomotor.

es

Conserve estas instrucciones con el actuador o con la documentación de la instalación!

 Este símbolo denota peligro y medidas para evitar daños personales y de la propiedad:

- Sólo el personal autorizado puede conectar los actuadores a 230 V CA.
- No exponer los cables de conexión del actuador al agua ni dejarlos en contacto con ésta.
- No sujetar los cables de conexión a la tubería o a la válvula de bola.

 Equipo con tipo de protección II (aislamiento protegido)

 Equipo con tipo de protección III (aislamiento protegido)

 **Atención!** el actuador no debe ser abierto.

Cableado y puesta en marcha

Referirse a las instrucciones de puesta en marcha del actuador y de la hoja técnica N4605.

fr

Cette instruction est à conserver avec le servomoteur ou avec la documentation de l'installation!

 Ce symbole signale un danger pour les personnes et les biens et les mesures y-afférentes:

- Le branchement des servomoteurs 230 V~ ne doit être effectué que par un personnel qualifié.
- Les câbles de raccordement du servomoteur ne doivent pas être en contact avec l'eau.
- Ne pas fixer le câble de raccordement du servomoteur sur la tuyauterie ou sur la vanne.

 Classe d'isolation II (isolation de protection)

 Classe d'isolation III (isolation de protection)

 **Attention!** Le servo-moteur ne doit pas être ouvert.

Câblage et mise en service

Se référer à la documentation de l'installation et à la fiche produit N4605 du servomoteur.

it

Queste istruzioni devono essere conservate con la documentazione dell'impianto!

 Questo simbolo indica – pericolo – il personale deve fare attenzione per evitare ferite o danni.

- I collegamenti a 230 V CA . devono sempre essere eseguiti da personale autorizzati.
- Non esporre all'acqua il cavo ed i collegamenti elettrici.
- Non attaccare il cavo di collegamento alle tubazioni o alla valvola a sfera.

 Apparecchi di protezione classe II (protezione isolamento)

 Apparecchio di protezione classe III (protezione isolamento)

 **Attenzione!** Il servocomando non deve essere aperto.

Collegamenti e messa in servizio

Consultare la documentazione per l'installazione e il folio tecnico (N4605) del servocomando.

da

Opbevar denne vejledning sammen med motoren eller med anlægsdokumentationen!

 Dette symbol gør opmærksom på farer og forholdsregler til beskyttelse af personer og genstande:

- Motorer til AC 230 V må kun tilsluttes af autoriserede personer.
- Motorens tilslutningskabler må ikke ligge i vand.
- Forbindelseskablet må ikke fastgøres til rørsystemet eller kugleventilen!

 Apparat i isoleringsklasse II (beskyttelsesisolering)

 Apparat i isoleringsklasse III (beskyttelsesisolering)

 **OBS!** Motoren må ikke åbnes.

Elektrisk tilslutning og idriftsættelse

Se den anlægsspecifikke dokumentation samt basisdokumentationen datablad N4605 for motorer.

zh

请将此安装指导文件与驱动器或现场文件保存在一起。

 此符号代表危险和须要采取措施以免对人及财产产生损害:

- 只有被授权的工程人员才可进行230V交流电压的电气安装。
- 不要将已连接电线的驱动器暴露在水中及将电线安放在水中。
- 请勿连接电缆至管道或球阀

 设备安全等级 II (绝缘保护)

 设备安全等级 III (绝缘保护)

 **注意!** 请不要打开驱动器

驱动器接线和调试

请参考调试指导和驱动器技术资料N4605。

C

de Montage auf Kugelhahn
 en Ball valve Mounting
 fr Montage sur vanne à boisseau sphérique
 sv Montera ställdonet på kulventilen







nl Montage op de Kogelafsluiter
 it Montaggio sulla valvola a sfera
 fi Asennus palloventtiiliin
 es Montaje sobre el válvula de bola

da Montering på kugleventil
 zh 裝配在球閥閥體上

1

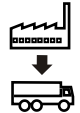
GSD..41.9A + V..60.15.. / V..60.20.. / V..60.25..

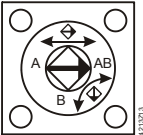
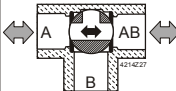
2

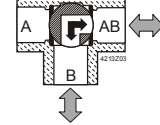
			GSD..41.9A + V..60..
VA..60..	—		⇒ 3
VB..60..T			⇒ 3
VBI60..L			⇒ 4

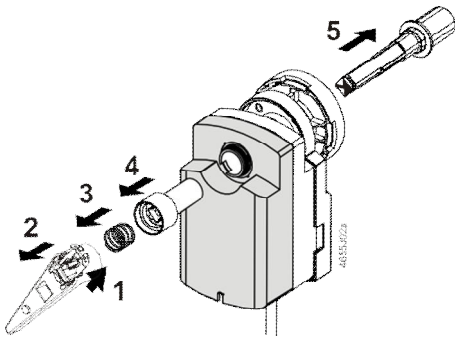
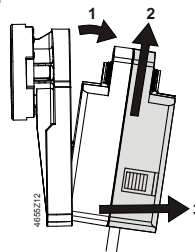
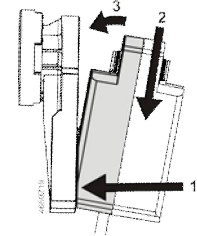
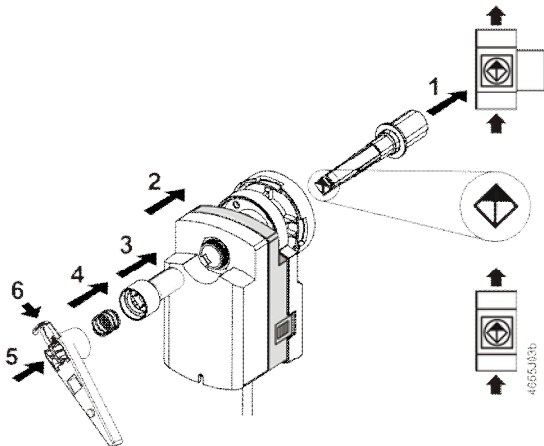
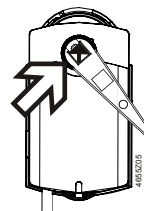
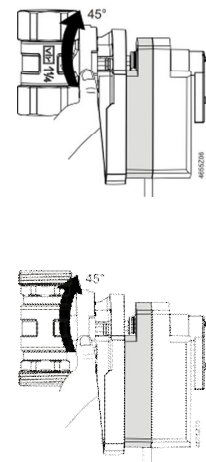
3**3.1****3.2****3.3****3.4****3.5**

4

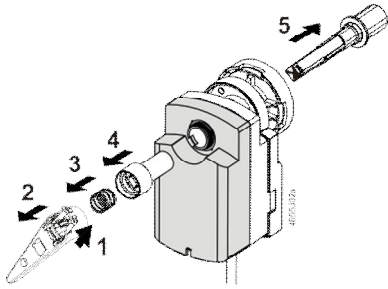

4.1

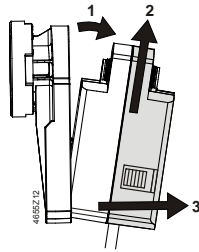

4.2

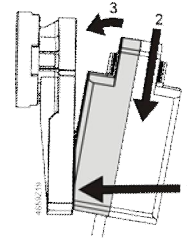

4.3

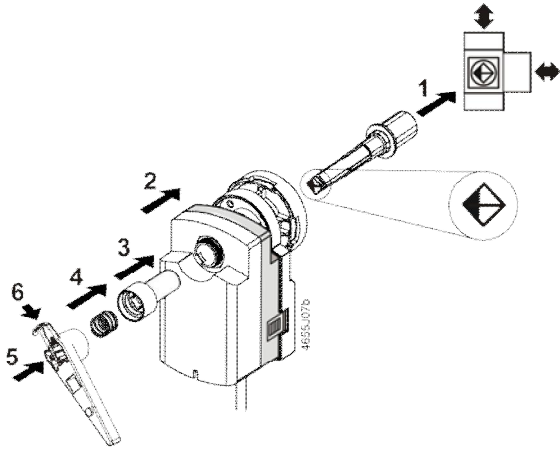

4.4

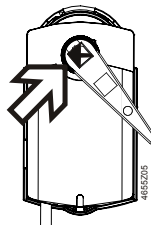

4.5

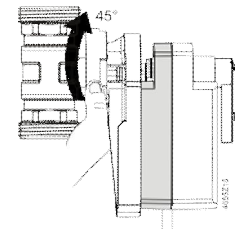
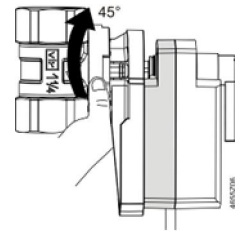

D

de Massbild
en Dimensions
fr Encombrement
sv Måttuppgift

nl Maatschets
it Ingombri
fi Mittapiirros
es Dimensiones

da Målskitse
zh 尺寸

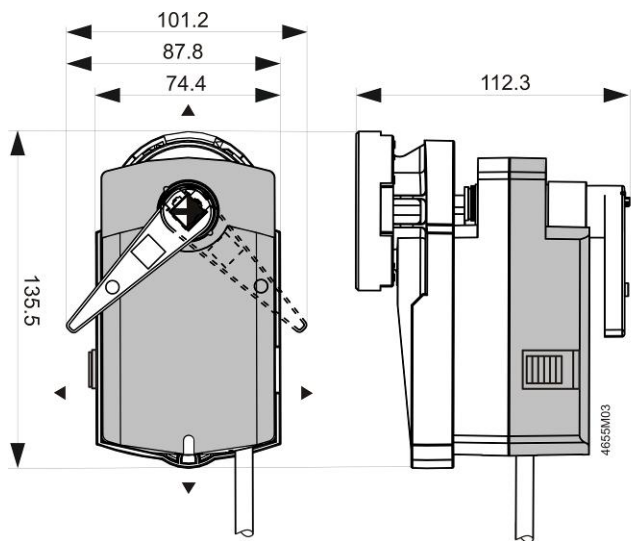

Minimum clearance from ceiling or wall for mounting, connection, operation, maintenance etc.

- ▶ = > 100 mm
- ▶▶ = > 200 mm

▶ Masse in mm
▶ Dimensions in mm
▶ Dimensions en mm
▶ Mått i mm
▶ Afmetingen in mm
▶ Dimensioni in mm
▶ Mitat mm
▶ Dimensiones en mm
▶ Mål i mm
▶ 尺寸单位 mm

E

de Geräteschaltpläne
 en Wiring diagrams
 fr Schémas de raccordement
 sv Kopplingsscheman

nl Aansluitschema's
 it Schemi di collegamento
 fi Kytentäkaaviot
 es Conexión eléctrico

da Apparatdiagrammer
 zh 接线图

GSD141.9A

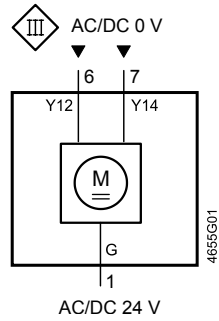

GSD341.9A

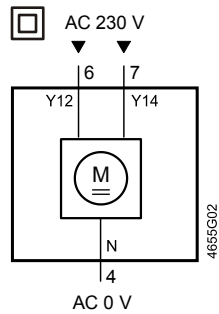

AC 24 V / DC 24 V
 Zweipunkt-Steuerung
 Two-position control
 Commande tout ou rien
 Tvåläges styrning
 Tweepuntsbesturing
 Comando a 2 posizioni
 Kaksipisteohjaus
 Control a 2 puntos
 On/off-styring
 开关控制

AC 230 V
 Zweipunkt-Steuerung
 Two-position control
 Commande tout ou rien
 Tvåläges styrning
 Tweepuntsbesturing
 Comando a 2 posizioni
 Kaksipisteohjaus
 Control a 2 puntos
 On/off-styring
 开关控制

de

Kabelbezeichnungen

Anschluss	Kabel				Bedeutung
	Code	Nr.	Farbe	Abkürzung	
Drehantriebe AC/DC 24 V	G	1	rot	RD	System Potential AC 24 V / DC 24 V
	Y12	6	violett	VT	Stellsignal Uhrzeigersinn AC/DC 0 V
	Y14	7	orange	OG	Stellsignal Gegenuhrzeigersinn AC/DC 0 V
Drehantriebe AC 230 V	N	4	blau	BU	Nullleiter
	Y12	6	schwarz	BK	Stellsignal Uhrzeigersinn AC 230 V
	Y14	7	weiss	WH	Stellsignal Gegenuhrzeigersinn AC 230 V

en

Wire designations

Connection	Cable				Meaning
	Code	No.	Color	Abbreviation	
Rotary actuators AC/DC 24 V	G	1	red	RD	System potential AC 24 V / DC V
	Y12	6	purple	VT	Positioning signal AC/DC 0 V, "Clockwise"
	Y14	7	orange	OG	Positioning signal AC/DC 0 V, "Counter-clockwise "
Rotary actuators AC 230 V	N	4	blue	BU	Neutral
	Y12	6	black	BK	Positioning signal AC 230 V, "Clockwise"
	Y14	7	white	WH	Positioning signal AC 230 V, "Counter-clockwise "

fr

Désignation des câbles

Câbles de raccordement	Câble				Signification
	Code	No.	Couleurs	Abbreviation	
servo-moteurs AC/DC 24 V	G	1	rouge	RD	Potentiel du système AC 24 V / DC 24 V
	Y12	6	violet	VT	Signal de commande AC/DC 0 V, "sens horaire"
	Y14	7	orange	OG	Signal de commande AC/DC 0 V "sens anti-horaire"
servo-moteurs AC 230 V	N	4	bleu	BU	Neutre
	Y12	6	noir	BK	Signal de commande AC 230 V "sens horaire"
	Y14	7	blanc	WH	Signal de commande AC230 V "sens anti-horaire"

连 接	线 缆				注 解
	端子号	端子	颜 色	缩 写	
驱动器 AC/DC 24 V	G	1	红色	RD	供电类型为 AC 24 V / DC 24 V 驱动器控制信号 AC/DC 0 V “顺时针旋转” 驱动器控制信号 AC/DC 0 V “逆时针旋转”
	Y12	6	紫色	VT	
	Y14	7	橙色	OG	
AC 230 V 驱动器	Y2	4	蓝色	BU	中性 驱动器控制信号 AC 230 V “顺时针旋转” 驱动器控制信号 AC 230 V “逆时针旋转”
	Y12	6	黑色	BK	
	Y14	7	白色	WH	