

- de** Montageanleitung
- en** Mounting instructions
- fr** Instructions de montage
- sv** Monteringsinstruktion
- nl** Montage-aanwijzing
- it** Istruzioni di montaggio
- fi** Asennusohje
- es** Instrucciones de montaje
- da** Monteringsvejledning
- pl** Instrukcja montażu
- cz** Montážní návod
- el** Οδηγίες εγκατάστασης
- ru** Инструкция по установке
- zh** 安裝指導

- Kugelhahn**
- Ball valve**
- Vanne à boisseau sphérique**
- Kulventilen**
- Kogelafsluiter**
- Valvola a sfera**
- Palloventtiilin**
- Válvula de bola**
- Kulventil**
- Zawory kulowe regulacyjne**
- Regulační kulové kohouty**
- Δίοδες σφαιρικές βάνες**
- Шаровые клапаны**
- 电动球阀**

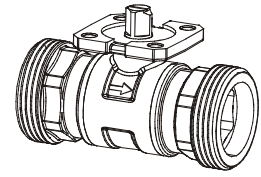

VAG60..

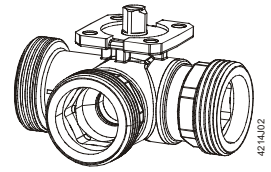

VBG60..

**VAG60..**  
**VBG60..T**  
**VBG60..L**

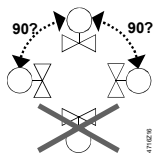

**1**

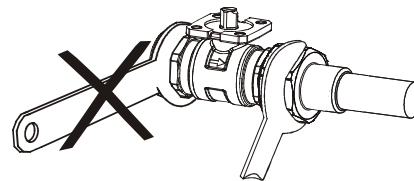
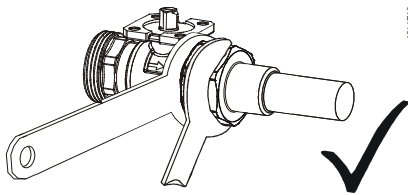

**2**

**2.1 VAG60..**

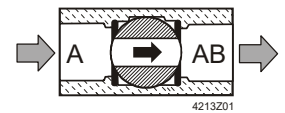
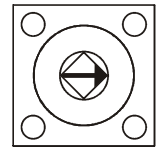
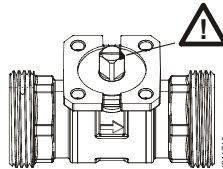

$A - AB = 100\%$

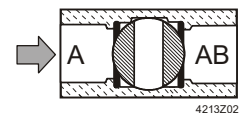
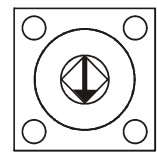
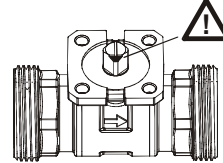

$A - AB = 0\%$

**2.2 VBG60..L**

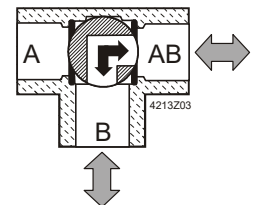
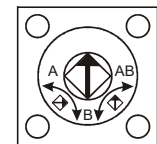
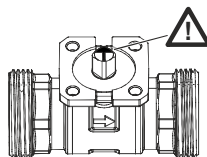

$B - AB (AB - B) = 100\%$

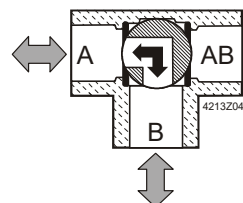
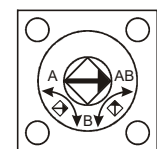
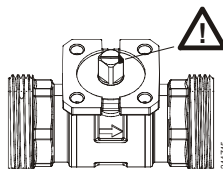
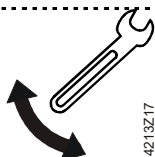

$$A - B (B - A) = 100 \%$$

### 2.3 VBG60..T



4214Z01

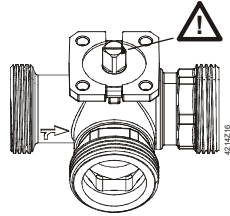

4214Z16

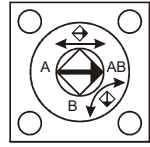

4214Z26

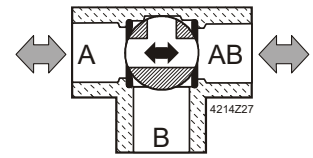

4214Z27

$$A - AB (AB - A) = 100 \%$$

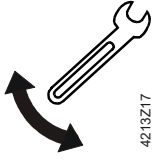

4213Z17

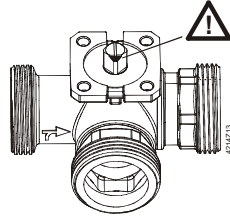

4214Z13

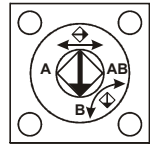

4214Z29

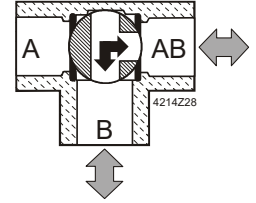

4214Z28

$$B - AB (AB - B) = 100 \%$$

### 3

#### VAG60..

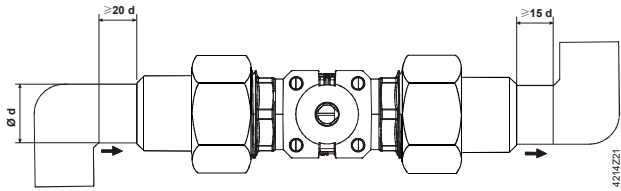

4214Z21

#### VBG60..

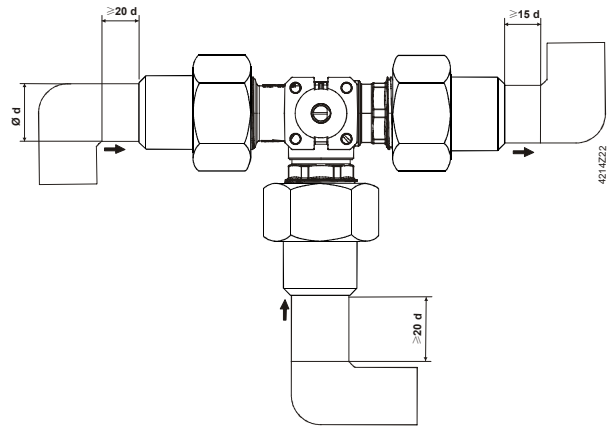

4214Z22

# 4

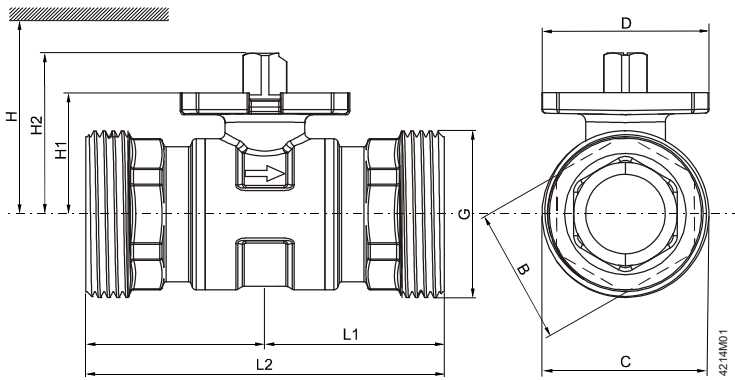

VAG60..	DN	B [mm]	C [mm]	D [mm]	G [Inch]	L1 [mm]	L2 [mm]	H1 [mm]	H2 [mm]	H				[kg]
										GSD..9A [mm]	QGD..9A [mm]	GMA..9E.. [mm]	GLB..9E.. [mm]	
VAG60.15-9	15	27	33	42	G 1 B	43.5	87	27.6	37.6	> 300	> 300	> 300	> 300	0.36
VAG60.20-17	20	35	42	42	G 1 ¼ B	44.7	89.4	30.5	40.5	> 300	> 300	> 300	> 300	0.55
VAG60.25-22	25	35	48	42	G 1 ½ B	44.7	89.4	30.5	40.5	> 320	> 320	> 300	> 300	0.57
VAG60.32-35	32	38	59.7	42	G 2 B	50.1	100.2	34.3	44.3			> 320	> 320	0.84
VAG60.40-68	40	49	65.7	42	G 2 ¼ B	58.3	116.6	39.8	49.8			> 320	> 320	1.29
VAG60.50-96	50	61	81.6	42	G 2 ¾ B	62	124	52.8	62.8			> 335	> 335	1.98

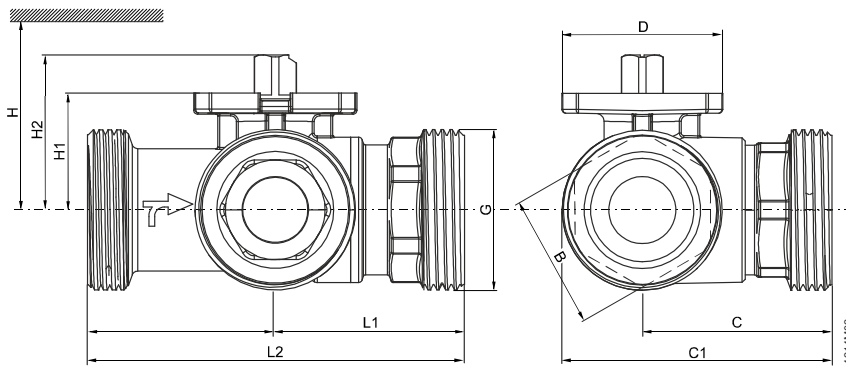

VBG60..T	DN	B [mm]	C [mm]	C1 [mm]	D [mm]	G [Inch]	L1 [mm]	L2 [mm]	H1 [mm]	H2 [mm]	H				[kg]
											GSD..9A [mm]	QGD..9A [mm]	GMA..9E.. [mm]	GLB..9E.. [mm]	
VBG60.15-8T	15	27	44.4	61	42	G 1 B	44.3	88.6	27.6	37.6	> 300	> 300	> 300	> 300	0.45
VBG60.20-13T	20	35	49.5	70	42	G 1 ¼ B	49	98	30.5	40.5	> 300	> 300	> 300	> 300	0.68
VBG60.25-13T	25	35	49.5	73	42	G 1 ½ B	49.2	98.4	30.5	40.5	> 320	> 320	> 300	> 300	0.75
VBG60.32-25T	32	38	63.7	94	42	G 2 B	57	114	34.3	44.3			> 320	> 320	1.2
VBG60.40-49T	40	49	74.3	107	42	G 2 ¼ B	63.8	127.6	39.8	49.8			> 320	> 320	1.84
VBG60.50-73T	50	61	82.3	123	42	G 2 ¾ B	69	138	52.8	62.8			> 335	> 335	2.83

VBG60..L	DN	B [mm]	C [mm]	C1 [mm]	D [mm]	G [Inch]	L1 [mm]	L2 [mm]	H1 [mm]	H2 [mm]	H				[kg]
											GSD..9A [mm]	QGD..9A [mm]	GMA..9E.. [mm]	GLB..9E.. [mm]	
VBG60.15-5L	15	27	44.4	61	42	G 1 B	44,3	88,6	27,6	37,6	> 300	> 300	> 300	> 300	0,45
VBG60.20-8L	20	35	49,5	70		G 1 ¼ B	49	98	30,5	40,5	> 300	> 300	> 300	> 300	0,68
VBG60.25-9L	25			73		G 1 ½ B	49,2	98,4			> 320	> 320	> 300	> 300	0,75
VBG60.32-13L	32	38	63,7	94		G 2 B	57	114	34,3	44,3			> 320	> 320	1,2
VBG60.40-25L	40	49	74,3	107		G 2 ¼ B	63,8	127,6	39,8	49,8			> 320	> 320	1,84
VBG60.50-37L	50	61	82,3	123		G 2 ¾ B	69	138	52,8	62,8			> 335	> 335	2,83

Issued by  
Siemens Switzerland Ltd  
Smart Infrastructure  
Global Headquarters  
Theilerstrasse 1a  
6300 Zug  
Switzerland  
Tel. +41 58-724 24 24  
[www.siemens.com/buildingtechnologies](http://www.siemens.com/buildingtechnologies)

© Siemens Switzerland Ltd, 2021

Technical specifications and availability subject to change without notice.