

ACVATIX™

## Electromotoric actuators for valves

SAX..



### Actuators with 20 mm stroke and 800 N force

- SAX31.. Operating voltage AC 230 V, 3-position control signal
- SAX61.. Operating voltage AC/DC 24 V, positioning signal 0...10V, 4...20 mA  
With position feedback, forced control, characteristic changeover
- SAX61../MO operating voltage AC/DC 24 V,  
RS-485 for Modbus RTU communication
- SAX81.. Operating voltage AC/DC 24 V, 3-position control signal
- For direct mounting on valves; no adjustments required
- Manual adjuster, position and status indication (LED)
- Optional functions with auxiliary switches, potentiometer, function module, stem heating

## Use

Electromotoric actuators to operate Siemens 2-port and 3-port valves, types V..F21.., V..F22.., V..F31.., V..F32.., V..F40.., V..F41.., V..F42.., V..F52.., and V..F53.. with 20 mm stroke as control and safety shut-off valves in heating, ventilation and air conditioning systems.

## Functions

Function	Description	Type
3-position control	A 3-position signal controls the actuator via connection terminals Y1 or Y2. The desired position is transmitted to the valve.	SAX31.., SAX81..
Modulating control	The modulating positioning signal provides stepless motor control. The positioning signal range (DC 0...10 V / DC 4...20 mA / 0...1000 Ω) corresponds to the positioning range (closed...open, or 0...100% stroke) in a linear manner.	SAX61..
Positioning signal and characteristic changeover	Setting with DIL switch. Factory setting: <ul style="list-style-type: none"> <li>Characteristic curve: log = Equal percentage (switch set to Off)</li> <li>Positioning signal: DC 0...10 V (switch set to Off)</li> </ul>	
Position feedback U	Signal returned to acquire the position via input.	SAX61.., SAX61../MO
Forced control (Z-mode)	Forced control helps override automatic mode and is implemented via higher control.	
Calibration	Carry out during initial commissioning. The actuator drives to the top or bottom end position; the measured values are saved.	
Valve seat detection	The actuators have power-dependent seat detection. After calibration, the exact valve stroke is stored in the actuator's memory.	
Foreign body detection	After clogging is detected, three attempts are made to get past clogging. If unsuccessful, the actuator continues to follow the positioning signal only within a limited range, and the LED blinks red.	
Modbus RTU (RS-485), not galvanically isolated	Setpoint 0...100 % valve position Actual value 0...100 % for valve position Override control Open / Close / Min / Max / Stop Setpoint monitoring and backup mode	SAX61../MO

## Type summary

Type	Item NO.	Stroke	Positioning force	Operating voltage	Positioning signal	Spring return time	Positioning time	LED	Manual adjustment <sup>3)</sup>	Auxiliary functions
SAX31.00 <sup>1)</sup>	S55150-A105	20 mm	800 N	AC 230 V	3-position	-	120 s	-	Push and fix	-
SAX31.03 <sup>1)</sup>	S55150-A106						30 s	Yes		4)
SAX61.03 <sup>2)</sup>	S55150-A100			DC ... 10 V DC 4...20 mA 0...1000 Ω	-					
SAX61.03U <sup>2)</sup>	S55150-A100-A100						AC 24 V DC 24 V	Modbus RTU		
SAX61.03/MO <sup>2)</sup>	S55150-A140			120 s	-					-
SAX81.00 <sup>2)</sup>	S55150-A102						30 s	-		
SAX81.03 <sup>2)</sup>	S55150-A103			3-position	-					-
SAX81.03U <sup>2)</sup>	S55150-A103-A100									

1) Approbation: CE

2) Approbation: CE, UL

3) Not designed for continuous operation.

4) Position feedback, forced control, characteristic changeover

5) Position feedback, forced control

### Scope of delivery

Actuators, valves and accessories are supplied in individual packs.

### Accessories/spare parts

#### Electrical accessories

Type	Auxiliary switch ASC10.51	Potentiometer ASZ7.5	Function module AZX61.1	Stem heating element ASZ6.6
Item No.	S55845-Z103	S55845-Z106	S55845-Z107	S55845-Z108
		Max. 2		Max. 1
SAX31..	Max. 2	Max. 1	-	
SAX61..		-	Max. 1	
SAX61../MO		-		
SAX81..		Max. 1	-	



#### Mechanical accessory

Type	Weather shield ASK39.1 <sup>1)</sup>
Item No.	S55845-Z109

## Ordering (example)

Type	Stock number	Designation	Number of pieces
SAX81.03	S55150-A103	Actuator	1
ASZ7.5	S55845-Z106	Potentiometer	1

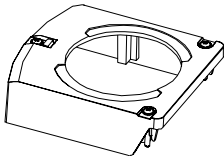
## Spare parts

Product number  Stock number		
8000060843	<b>Housing cover</b>	<b>Screw (valve stem coupling)</b>
		 <b>U-bracket</b>
		

## Equipment combinations

### 2-port valves VV.. (control or safety shutoff valves)

Valve type		DN	PN class	$k_{vs}$ [m <sup>3</sup> /h]	Data sheet
VVF21..	Flange	25...80	6	1.9...100	N4310
VVF22..				2.5...100	N4401
VVF31..				15...80	10
VVF32..		1.9...100	N4402		
VVF40..		1.9...100	N4330		
VVF41..		50	16	19 / 31	N4340
VVG41..	Thread	15...50		0.63...40	N4363
VVF42..	Flange	15...80		1.6...100	N4403
VVF42..K		50...80	40...100		
VVF52..		15...40	25	0.16...25	N4373
VVF53..		15...50		0.16...40	N4405

### 3-port valves VX.. (Control valves for functions "mixing" and "distribution")

Valve type		DN	PN class	$k_{vs}$ [m <sup>3</sup> /h]	Data sheet
VXF21..	Flange	25...80	6	1.9...100	N4410
VXF22..				2.5...100	N4401
VXF31..				15...80	10
VXF32..		1.9...100	N4402		
VXF40..		1.9...100	N4430		
VXF41..		15...80	16	1.9...31	N4440
VXG41..	Thread	15...50		1.6...40	N4463
VXF42..	Flange	15...80		1.6...100	N4403
VXF53..		15...50	25	1.6...40	N4405

Title	Contents	Document ID
Actuators SAX..., SAY..., SAV..., SAL.. for valves	Basic documentation: Detailed information on stroke actuators including Modbus types Stroke actuators for valves with 15/20/40 mm stroke and rotary actuators for butterfly valves	CE1P4040en
Electromotoric actuators for valves SA..., Modbus RTU	Data sheet: Modbus communication profiles	A6V101037195
Mounting instructions G..161../MO and S..6/MO	Mounting instructions: Mounting and installation instructions for Modbus actuators	A5W00027551
Valve Actuator DIL Switch Characteristic Overview	Commissioning / Configuration: Describes the characteristics of valve and actuator combinations, it describes the DIL Switch function.	A6V12050595

Related documents such as environmental declarations, CE declarations, etc., can be downloaded at the following Internet address:

<http://siemens.com/bt/download>

Notes

Safety

	<p><b>⚠ CAUTION</b></p>
	<p><b>National safety regulations</b> Failure to comply with national safety regulations may result in personal injury and property damage.</p> <ul style="list-style-type: none"> <li>● Observe national provisions and comply with the appropriate safety regulations.</li> </ul>

	<p><b>⚠ WARNING</b></p>
	<p><b>Risk of burns from hot actuator brackets</b> The actuator brackets on heating plants can also become hot from the contact with the hot valve during operation. The temperature of the actuator bracket can reach 100 °C.</p> <p>When servicing the actuator:</p> <ul style="list-style-type: none"> <li>● Switch off both pump and operating voltage.</li> <li>● Close the main shutoff valve in the piping.</li> <li>● Allow the piping to cool off.</li> </ul>

**SAX31.. / SAX81..**

3-position actuators must be controlled by a controller, see Connection diagrams [→ 14].

**SAX61..**

Up to 10 actuators can drive in parallel on a controller output with a rating of 1 mA. Modulating actuators have an input impedance of 100 kΩ.

**SAX61../MO**

The Modbus converter is designed for analog control at 0...10 V.



Keep the analog signal setting on the actuator as is (switch 1 to OFF); adjustment not permitted.

The actuators are factory configured for equal-percentage characteristic.



DIL switch (internal actuator characteristic changeover) to "log" (switch 2 to OFF).

**ASZ7.5**

Actuators with a DC 0...9.8 V feedback signal are recommended for the combination SIMATIC S5/S7 and position feedback.

Signal peaks in potentiometer ASZ7.5 may result in error messages on Siemens SIMATIC. This is not the cause, however, when combined with Siemens HVAC controllers. The reason is the higher resolution and faster reaction time on SIMATIC.

Use the potentiometer as voltage divider on the 3-wire connection. Powering the potentiometer over the wiper may shorten the life cycle of the potentiometer. Signal peaks increase in frequency and scope over the lifespan in this operating mode.

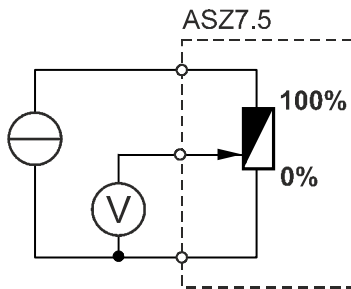

## Mounting

### Mounting positions

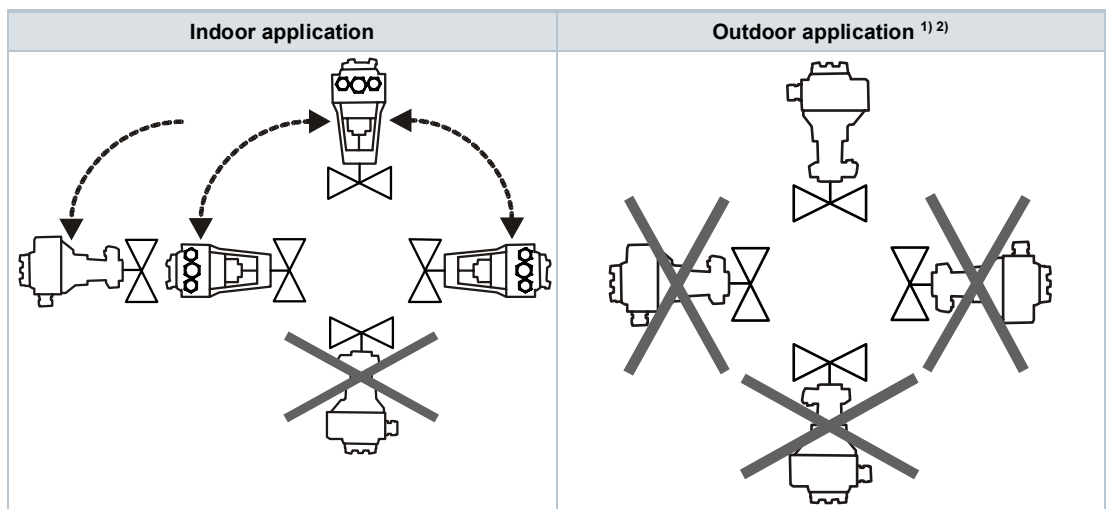

1) Only together with weather shield ASK39.2. IP54 housing protection remains unchanged.

2) SAX61.../MO is not intended for outdoor use.

## Maintenance

The actuators are maintenance-free.

## Disposal

	<p>The device is considered an electronic device for disposal in accordance with the European Guidelines and may not be disposed of as domestic garbage.</p> <ul style="list-style-type: none"><li>• Dispose of the device through channels provided for this purpose.</li><li>• Comply with all local and currently applicable laws and regulations.</li></ul>
---	---

## Warranty service

Technical data on specific applications are valid only together with Siemens products listed under "Equipment combinations". Siemens rejects any and all warranties in the event that third-party products are used.

## Technical data

Power		
Operating voltage		
SAX31..		AC 230 V ±15%
SAX61..		AC 24 V ± 20 % / DC 24 V +20 % / -15 % (SELV / PELV)
SAX81..		
External supply line fusing (EU)		<ul style="list-style-type: none"> <li>Non-renewable fuse 6...10 A slow</li> <li>Circuit break max. 13 A, tripping characteristic B, C, D to EN 60898</li> <li>Power source with current limitation of max. 10 A</li> </ul>
Fusing per DIN 57100 part 430 (supply line)		6...10 A slow
Power consumption at 50 Hz		
SAX31.00	Stem retracts/extends	3.5 VA / 2 W
SAX31.03		6 VA / 3.5 W
SAX61.03..		8 VA / 3.75 W
SAX61.03/MO		8.7 VA / 4.25 W
SAX81.00		3.5 VA / 2.25 W
SAX81.03..		5 VA / 3.75 W
Typical inrush current <sup>1)</sup> (3-position actuators)		
SAX31..		2.3 A
SAX81..		4.5 A

Operating data	
Positioning times (with the specified nominal stroke)	The positioning time may vary depending on the type of valve (Type summary [→ 3])
SAX31.00, SAX81.00	120 s
SAX31.03, SAX61.03.., SAX81.03..	30 s
Positioning force	800 N
Nominal stroke	20 mm
Working stroke range at which the actuator is calibrated	8...23 mm
Permissible media temperature (valve fitted)	-25...130 °C

Signal inputs		
Positioning signal "Y"		
SAX31.., SAX81..		3-position
SAX31..	Voltage	AC 230 V ±15%
SAX81..		AC 24 V ± 20% / DC 24 V + 20% / - 15%
SAX61..		
DC 0...10 V	Power consumption	≤ 0.1 mA
	Input impedance	≥100 kΩ
DC 4...20 mA	Power consumption	DC 4...20 mA ± 1%
	Input impedance	≤ 500 kΩ



Communication SAX61../MO		
Communication protocol		
Modbus RTU		RS-485, not galvanically isolated
Number of nodes		Max. 32
Address range		1...247 / 255
	Factory setting	255
Transmission formats		1-8-E-1 / 1-8-O-1 / 1-8-N-1 / 1-8-N-2
	Factory setting	1-8-E-1
Baud rates (kbaud)		Auto / 9.6 / 19.2 / 38.4 / 57.6 / 76.8 / 115.2
	Factory setting	Auto
Bus termination		120 Ω electronically switchable
	Factory setting	Off

Parallel connection	
SAX61..	≤ 10 (depending on controller output)

Forced control		
Z positioning signal		
SAX61..		R = 0...1000 Ω, G, G0
	R = 0...1000 Ω	Stroke proportional to R
	Z connected to G	Max. stroke 100 % <sup>2)</sup>
	Z connected to G0	Max. stroke 0 % <sup>2)</sup>
	Voltage	Max. AC 24 V ± 20 % Max. DC 24 V +20% / -15%
	Power consumption	≤ 0.1 mA

Position feedback		
Position feedback U		
SAX61..		DC 0...10 V
	Load impedance	> 10 kΩ resistive
	Load	Max. 1 mA

Connection cables		
Wire cross-sectional areas		0.13...1.5 mm <sup>2</sup> , AWG 24...16 <sup>3)</sup>
Cable entries		
SAX..		EU: <ul style="list-style-type: none"> <li>• 2 entries ø 20.5 mm (for M20)</li> <li>• 1 entry ø 25.5 mm (for M25)</li> </ul>
SAX..U		US: <ul style="list-style-type: none"> <li>• 3 entries ø 21.5 mm for ½" tube connection</li> </ul>
SAX61../MO		
	Fixed connection cable	0.9 m
	Number of cores	5 x 0.75 mm <sup>2</sup>

Degree of protection and class		
Housing from vertical to horizontal		IP 54 as per EN 60529 <sup>4)</sup>
Protection class		To EN 60730-1
SAX31..	AC 230 V	II
SAX61..	AC / DC 24 V	III
SAX81..		

Environmental conditions		
Operation		IEC 60721-3-3
	Climatic conditions	Class 3K5
	Mounting location	Indoors (weather-protected) <sup>4)</sup>
	Temperature, general	-5...<55 °C
	Humidity (non-condensing)	5...95 % r.h.
Transportation		IEC 60721-3-2
	Climatic conditions	Class 2K3
	Temperature	-25...70 °C
	Humidity	5...95 % r.h.
Storage		IEC 60721-3-1
	Climatic conditions	Class 1K3
	Temperature	-15...55 °C
	Humidity	5...95 % r.h.
Max. media temperature when mounted on valve		130 °C

Directives and standards		
Product standard		EN 60730-x
Electromagnetic compatibility (field of use)		For residential, commercial, and industrial environments
EU conformity (CE)		CE1T4501X1 <sup>5)</sup>
RCM conformity		CE1T4515X4 <sup>5)</sup>
EAC compliance		Eurasian compliance for all SAX..
UL, cUL	AC 230 V	-
	AC / DC 24 V	UL 873 <a href="http://ul.com/database">http://ul.com/database</a> ; file number E35198

Environmental compatibility
Product environmental declarations 71 7331 0559 <sup>5)</sup> und A6V101083254 <sup>5)</sup> include data on environmentally friendly product design and testing (RoHS compliance, material composition, packaging, environmental benefits, disposal).

Dimensions
See Dimensions [→ 16]

Accessories		
Potentiometer ASZ7.5 <sup>6)</sup>		0...1000 Ω ± 5 %
	Voltage	DC 10 V
	Current rating	<4 mA
Auxiliary switch ASC10.51 <sup>6)</sup>	Switching capacity	AC 24...230 V, 6 (2) A, potential free
External fusing of supply line		<ul style="list-style-type: none"> <li>• Non-renewable fuse 6...10 A slow</li> <li>• Circuit break max. 13 A, tripping characteristic B, C, D to EN 60898</li> <li>• Power source with current limitation of max. 10 A</li> </ul>
US installation, UL & cUL		AC 24 V class 2, 5 A general purpose
Stem heating element ASZ6.6	Operating voltage	AC/DC 24 V ± 20 %.
	Power consumption	50 VA, 30 W
	Switch-on current (cold)	Max. 8.5 A (max. temperature 85 °C/185 F)

- 1) Switching time for RMS value of the sine wave at nominal voltage
- 2) Observe acting direction of DIL switches
- 3) AWG = American wire gauge
- 4) For outdoor operation, always use weather shield ASK39.1, housing protection class IP 54 remains as is. SAX61../MO is not intended for outdoor use.
- 5) Documents can be downloaded at <http://www.siemens.com/bt/download>
- 6) UL-approved component 

## Connection diagrams

### Internal Diagrams

#### SAX31..

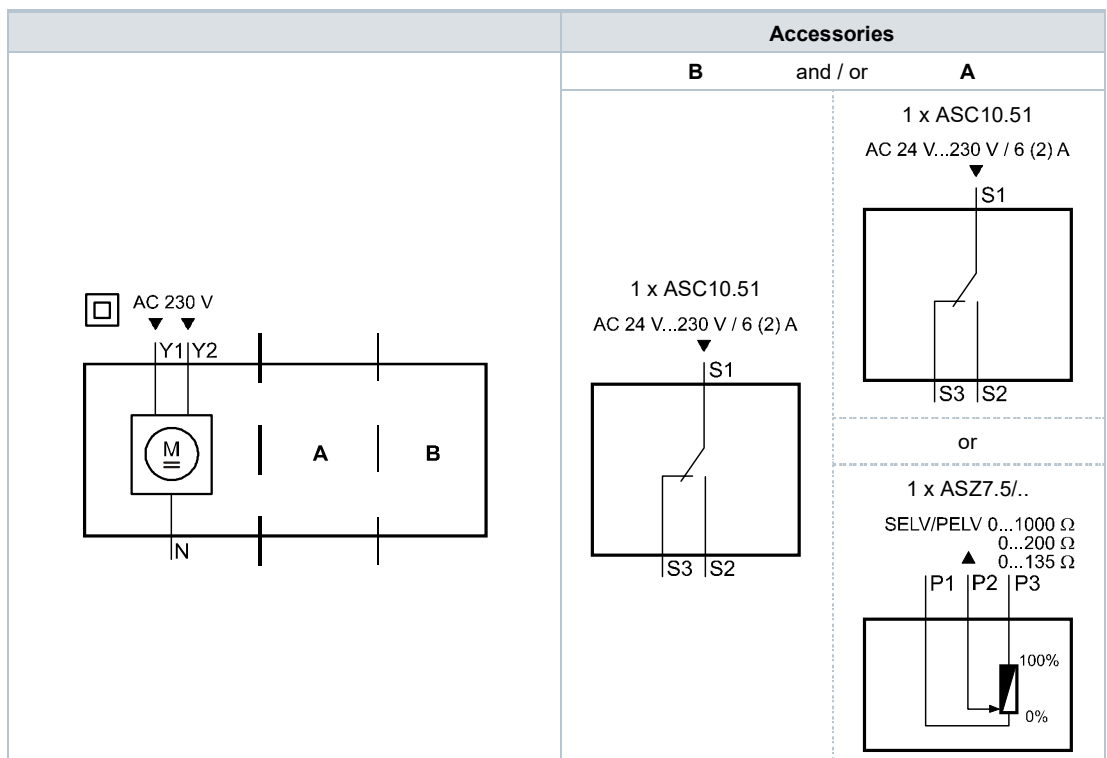

## SAX61..

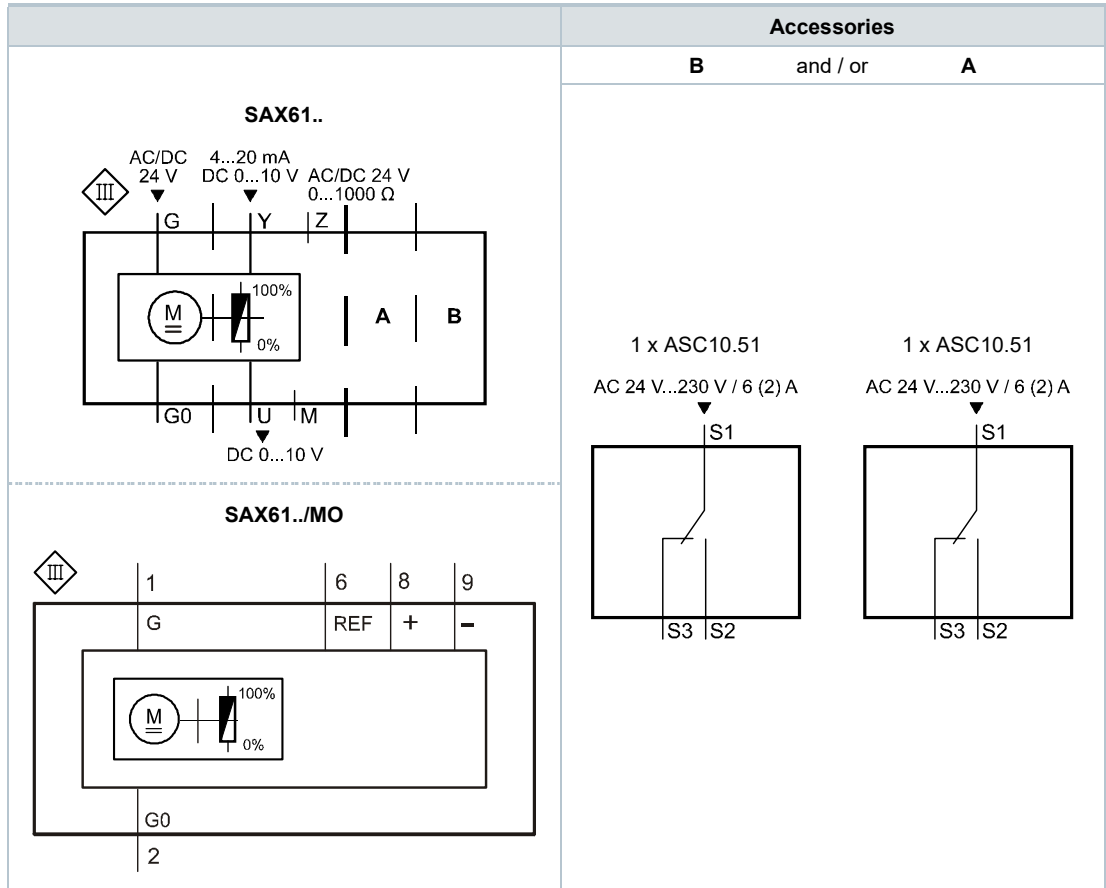

## SAX81..

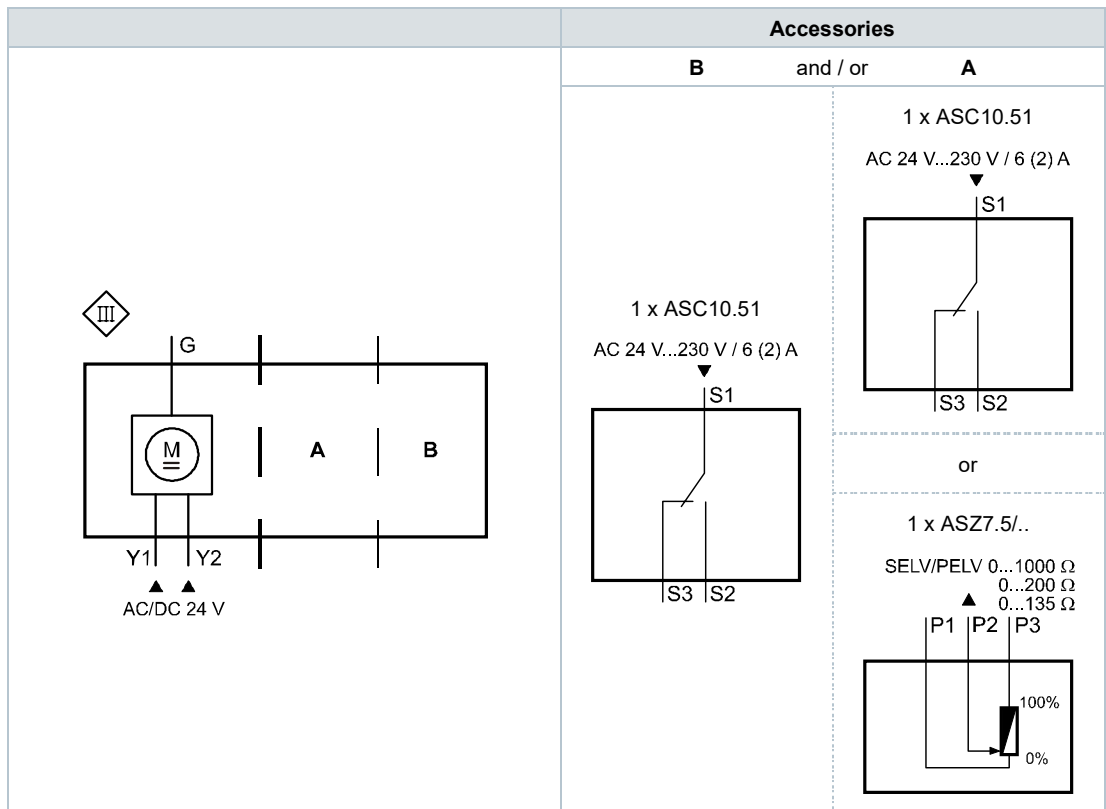

## Connection terminals

### SAX31..

	AC 230 V	3-position
<b>N</b>	System neutral (SN)	
<b>Y1</b>	Positioning signal (actuator's stem extends)	
<b>Y2</b>	Positioning signal (actuator's stem retracts)	

### SAX61..

	AC / DC 24 V	D 0...10 V 4...20 mA 0...1000
<b>G0</b>	System neutral (SN)	
<b>G</b>	System potential (SP)	
<b>Y</b>	Positioning signal for DC 0...10 V / 4...20 mA	
<b>M</b>	Measuring neutral	
<b>U</b>	Position feedback DC 0...10 V - (System neutral is measuring ground M)	
<b>Z</b>	Control signal forced control	

### SAX61../MO

	AC / DC 24 V	Modbus RTU connecting cable
<b>G0</b>	System neutral (SN)	black
<b>G</b>	System potential (SP) AC 24 V / DC 24 V	red
<b>REF</b>	Reference line (Modbus RTU)	violet
<b>+</b>	Bus + (Modbus RTU)	gray
<b>-</b>	Bus - (Modbus RTU)	pink

### SAX81..

	AC / DC 24 V	3-position
<b>G</b>	System potential (SP)	
<b>Y1</b>	Positioning signal (actuator's stem extends)	
<b>Y2</b>	Positioning signal (actuator's stem retracts)	

## Connection diagrams

### SAX31..

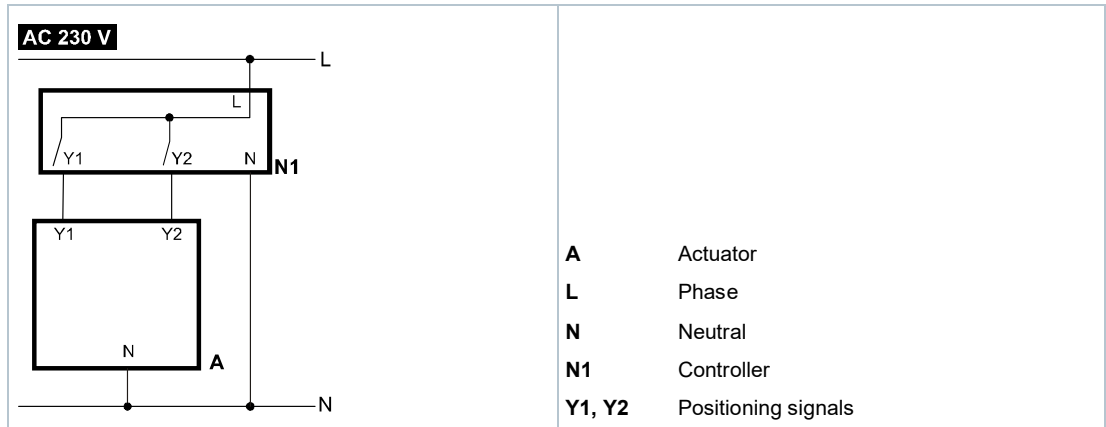

### SAX61..

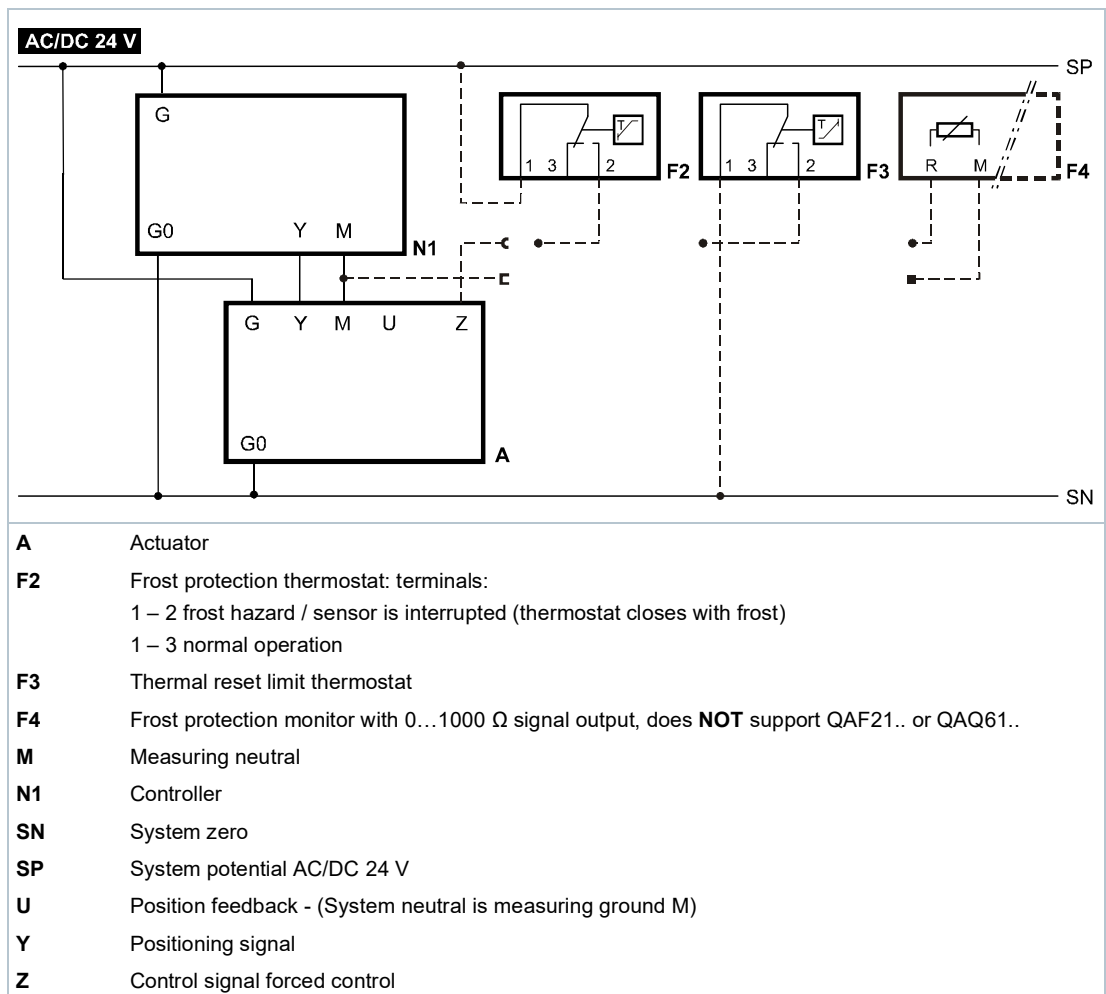

## SAX61../MO

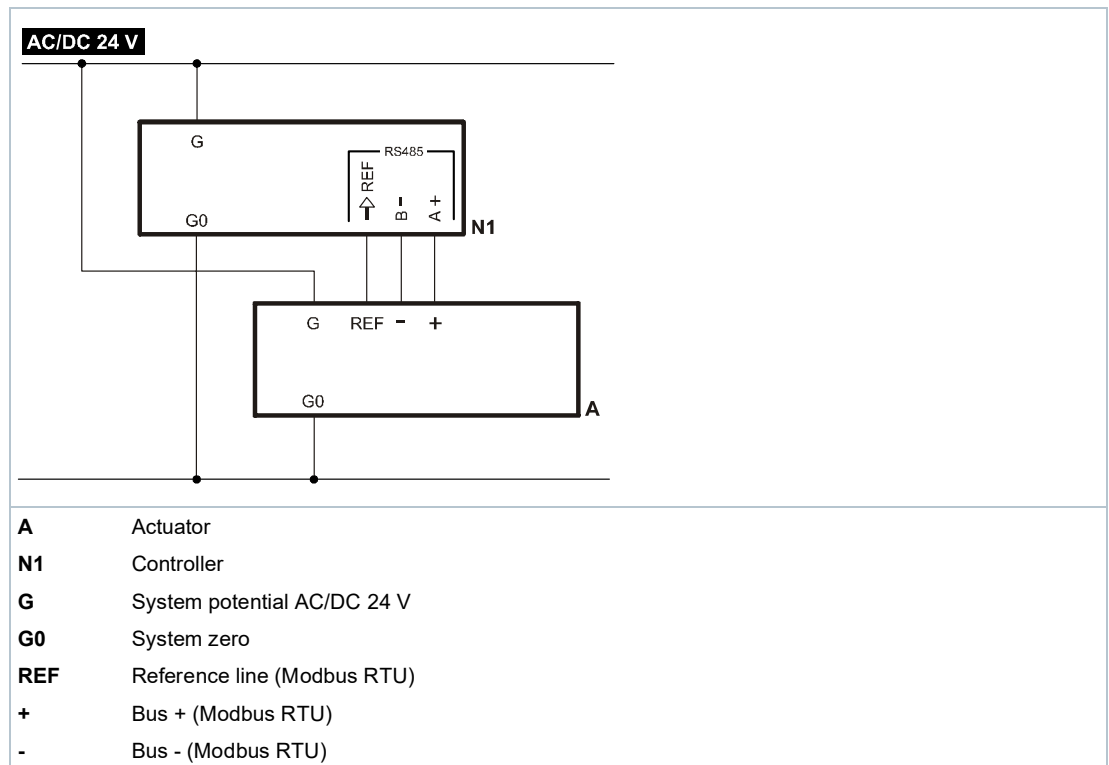

## SAX81..

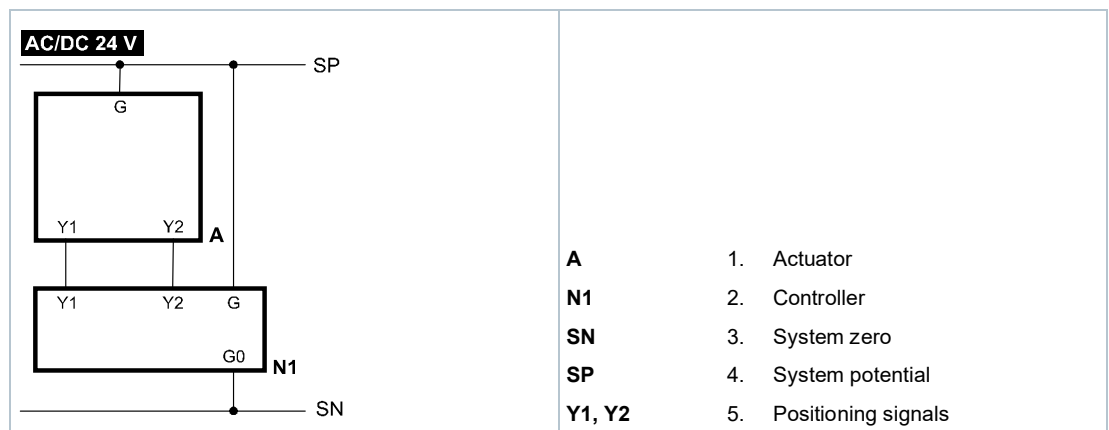

Actuator

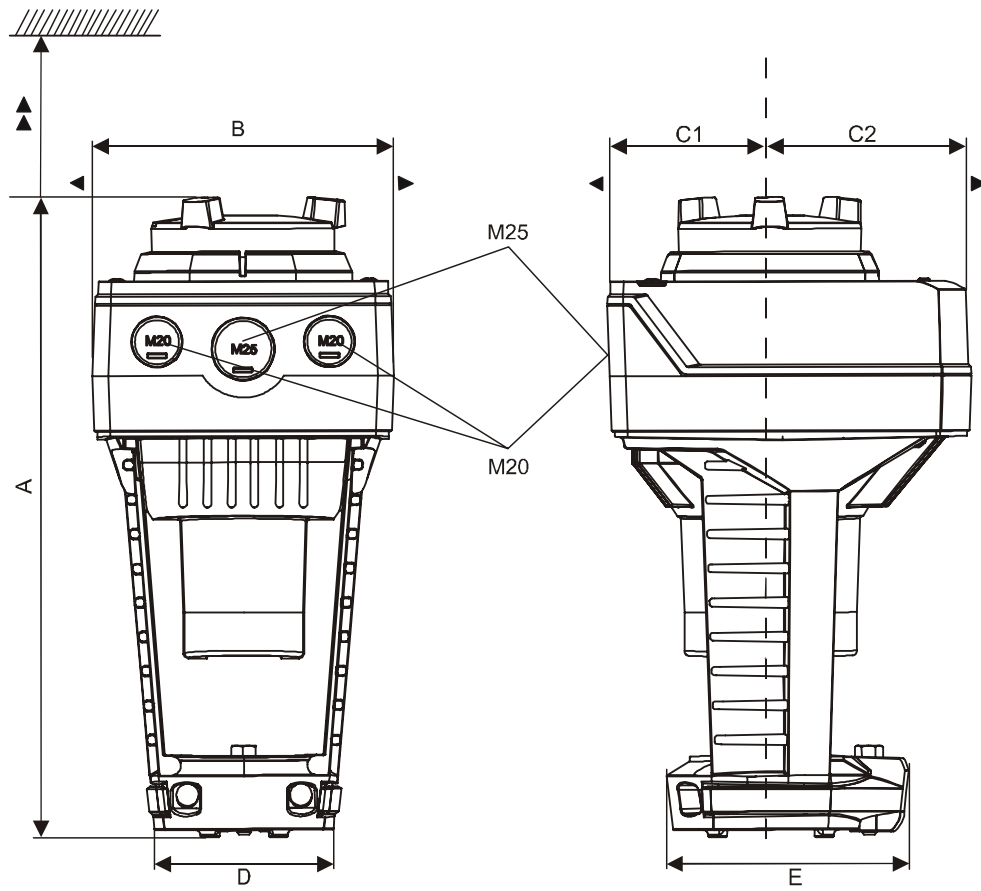

Type	A	B	C	C1	C2	D	E	▶	▶▶	kg
	[mm]									[kg]
SAX..(U <sup>1)</sup> )	242	124	150	68	82	80	100	100	200	1,780
SAX61../MO <sup>2)</sup>										1,930
With ASK39.1 (SAX..U <sup>1)</sup> )	267	154	300	200	100	-			2,010	

- <sup>1)</sup> SAX..U: For ½" tube connections (ø 21.5 mm) – 1,850 kg / 2,080 kg with ASK39.1
- <sup>2)</sup> Device has fixed connection cable – left cable entry occupied



### External Modbus converter

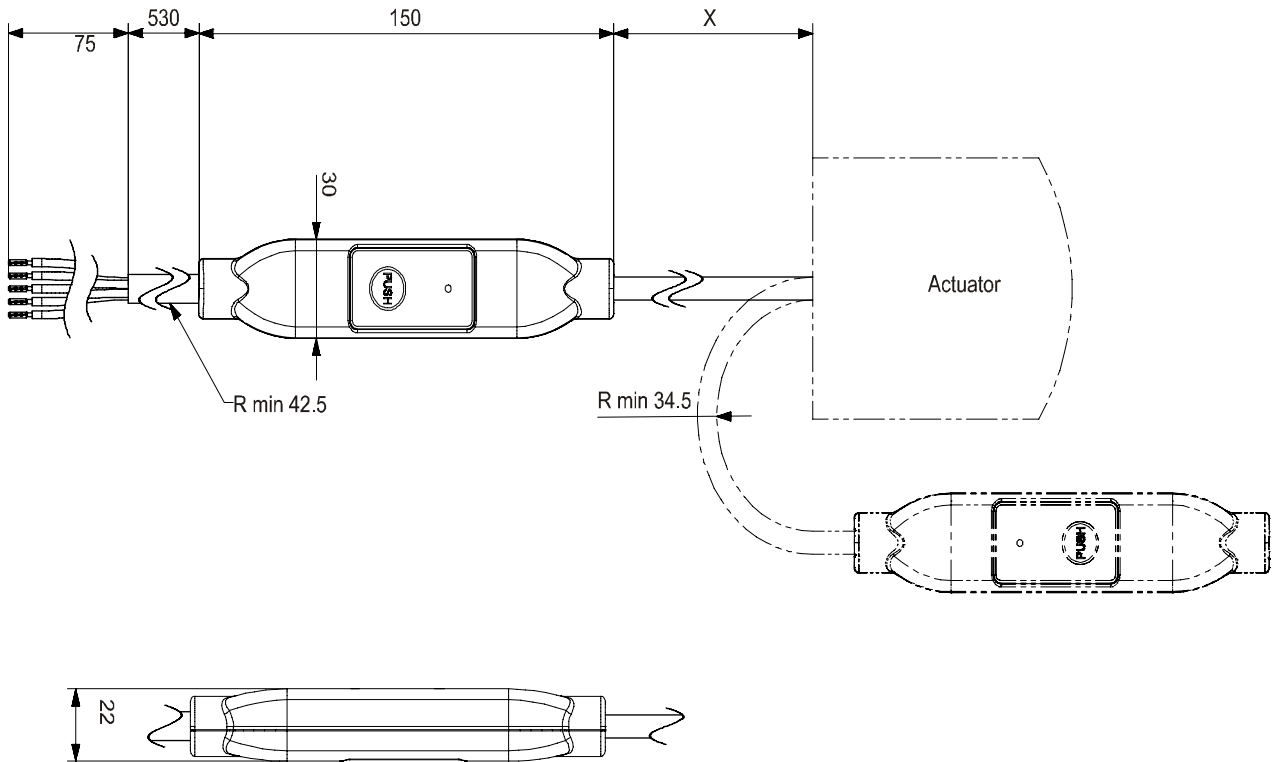

Dimensions in mm

Type	X	kg
	[mm]	[kg]
SAX61../MO	250	0.15 <sup>1)</sup>

<sup>1)</sup> Included in total weight.

## Revision numbers

Type	Valid from rev. no.
SAX31.00	..H
SAX31.03	..H
SAX61.03	..I
SAX61.03/MO	..I
SAX81.00	..I
SAX81.03	..I