



ACVATIX™

Electromotoric rotary actuators for butterfly or slipper valves

SAL..

with 90° rotary angle

-
- SAL31.. Operating voltage AC 230 V, 3-position control signal
 - SAL61.. Operating voltage AC/DC 24 V, control signal 0...10 V, 4...20 mA, 0...1000 Ω
 - SAL81.. Operating voltage AC/DC 24 V, 3-position control signal
 - SAL61.. Position feedback, override control
 - For direct mounting on butterfly or slipper valves; no adjustments required
 - Manual adjuster, position indicator and status indication with LED
 - Optional functions with auxiliary switches, potentiometer

Use

For the operation of Siemens butterfly and slipper valves, types VKF41..., VKF46..., VFW41..., VFL41..., VFW41..U and VBF21.. as control or shutoff valves in heating, ventilation and air conditioning systems.

Type summary

Product no.	Stock no.	Angular rotation	Torque	Operating voltage	Positioning signal	Positioning time	LED	Manual adjuster ¹⁾	Extra functions
SAL31.00T10 ¹⁾	S55162-A108	90°	10 Nm	AC 230 V	3-position	120 s	-	Push and fix	-
SAL31.00T20 ¹⁾	S55162-A110		20 Nm						
SAL31.00T40 ¹⁾	S55162-A111		40 Nm						
SAL31.03T10 ¹⁾	S55162-A109		10 Nm	AC/DC 24 V	DC 0...10 V DC 4...20 mA 0...1000 Ω	30 s			
SAL31.03T10/F05 ¹⁾	S55162-A121								
SAL61.00T10 ²⁾	S55162-A100		20 Nm	120 s	✓	Position feedback, forced control			
SAL61.00T20 ²⁾	S55162-A102		40 Nm						
SAL61.00T40 ²⁾	S55162-A103		10 Nm	30 s	-	-			
SAL61.03T10 ²⁾	S55162-A101								
SAL61.03T10/F05 ²⁾	S55162-A123		20 Nm	120 s	-	-			
SAL81.00T10 ²⁾	S55162-A104		40 Nm						
SAL81.00T20 ²⁾	S55162-A106		10 Nm	30 s	-	-			
SAL81.00T40 ²⁾	S55162-A107								
SAL81.03T10 ²⁾	S55162-A105		10 Nm	30 s	-	-			
SAL81.03T10/F05 ²⁾	S55162-A122								

¹⁾ Approbation: CE

³⁾ Not designed for continuous operation

²⁾ Approbation: CE, UL

Electrical accessories

Product no.	Auxiliary switch ASC10.51	Potentiometer ASZ7.5	Function module AZX61.1
Stock no.	S55845-Z103	S55845-Z106	S55845-Z107
Max. 2 in total			
SAL31..	Max. 2	Max. 1	-
SAL61..	Max. 2	-	Max. 1 AZX61.1
SAL81..		Max. 1	-

Note: ASZ7.5

For the combination SIMATIC S5/S7 and position feedback message, we recommend actuators with DC 0...9.8 V feedback signals.

The signal peaks that occur in the potentiometer ASZ7.5 may result in error messages on Siemens SIMATIC.

This is not the case when combined with Siemens HVAC controllers.

The reason is that SIMATIC has a higher resolution and faster response time.

Use a 3-wire connection as the voltage divider for the potentiometer.

Powering the potentiometer over the wiper may result in a shorter lifecycle.

Signal peaks occurring in this operating mode increase in frequency and severity throughout its lifecycle.

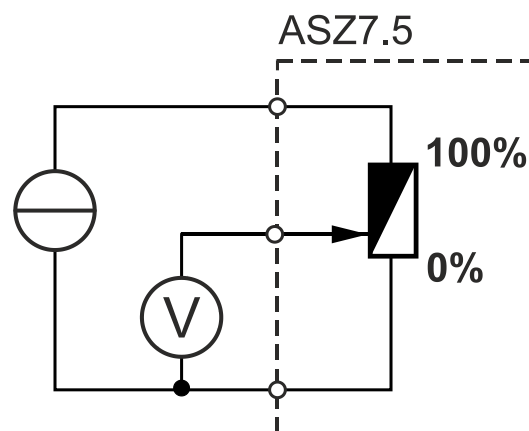

Mechanical accessories

Product no.	Weather shield ASK39.1	Mounting set				
		ASK31N for VBF21..	ASK32N		ASK33N for VKF41..	ASK35N for VKF45.. ²⁾
			VBF21..	VBI31.. ¹⁾ VCI31.. ¹⁾ VBG31.. ¹⁾		
Stock no.	S55845-Z109	S55845-Z100	S55845-Z211		S55845-Z101	S55845-Z102
SAL..T10..	Max. 1	DN 65...150	DN 40...50	✓	✓	-
SAL..T20		-	-	-	-	DN 40...65
SAL..T40		-	-	-	-	DN 150...200

¹⁾ Types VBI31.., VCI31.., and VBG31.. are available only while stock lasts from 2019 on.

²⁾ Type VKF45.. was replaced by type VKF46.. in the year 2000.

Ordering



Example

Product no.	Stock no.	Description	Quantity
SAL31.00T10	S55162-A108	Rotary actuator	1
ASZ7.5	S55845-Z106	Potentiometer	1





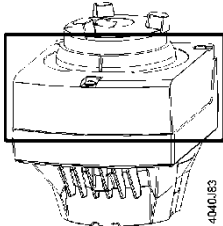



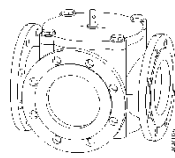

Delivery

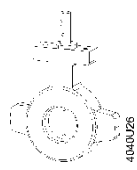
Actuators, valves and accessories are supplied in individual packs.

Spare part kit

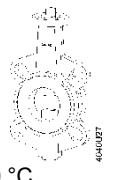
Stock number 8000060844	Housing cover 	
	2 adapters  1 pc. 14 mm 1 pc. 11 mm	
	4 screws  2 pcs. M5 x 20 mm 2 pcs. M6 x 20 mm	

Combinations

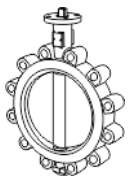
SAL..					SAL..T10	SAL..T10/F05	SAL..T20	SAL..T40	
					Angular rotation Torque		90°		
					10 Nm		20 Nm	40 Nm	
Slipper valves		Data Sheet	Valve type ¹⁾	DN	k _{vs} [m ³ /h]	Mountingset	Δp _{max} [kPa]		
  1 °C...120 °C	PN6	N4241	VBF21.40	40	25	ASK32N	30	-	-
			VBF21.50	50	40				
			VBF21.65	65	63				
			VBF21.80	80	100	ASK31N			
			VBF21.100	100	160				
			VBF21.125	125	550				
			VBF21.150	150	820				
Butterfly valves					Δp _s [kPa]				
  -10 °C...120 °C	PN16	N4131	VKF41.40	40	50	ASK33N	500	-	-
			VKF41.50	50	80				
			VKF41.65	65	200				
			VKF41.80	80	400				
			VKF41.100	100	760				
			VKF41.125	125	1000				
			VKF41.150	150	2100				
			VKF41.200	200	4000				
  -20 °C...120 °C	PN6/10/16	A6V101029254	VFW41.40U	40	40	-	-	500	-
			VFW41.50U	50	100				
			VFW41.65U	65	155				
			VFW41.80U	80	260				
			VFW41.100U	100	520				
			VFW41.125U	125	820				
			VFW41.150U	150	1600				
			VFW41.200U	200	4000				
  -10 °C...120 °C	PN16	N4136	VKF46.40	40	50	-	-	-	1600
			VKF46.50	50	85				
			VKF46.65	65	215				
			VKF46.80	80	420				
			VKF46.100	100	800				
			VKF46.125	125	1010				
  -20 °C...120 °C	PN6/10/16	A6V101029242	VFW41.40	40	40	ASK41NF04SP	-	-	1600
			VFW41.50	50	100				
			VFW41.65	65	155				
			VFW41.80	80	260	ASK41NF05SP			
			VFW41.100	100	520				
			VFW41.125	125	820				
  -20 °C...120 °C	PN10/16	A6V101029242	VFL41.40	40	40	ASK41NF04SP	-	-	1600
			VFL41.50	50	100				
			VFL41.65	65	155				
			VFL41.80	80	260	ASK41NF05SP			
			VFL41.100	100	520				
			VFL41.125	125	820				

Product documentation

Detailed information about the New Generation actuators can be found in the basic documentation "Electromotoric actuators SAX.., SAL.." (CE1P4040en).

This document describes the characteristics of valve and actuator combinations, it describes the DIL Switch function:

A6V12050595 Valve Actuator DIL Switch Characteristic Overview

Related documents such as environmental declarations, CE declarations, etc., can be downloaded at the following Internet address: <http://siemens.com/bt/download>

Notes

Engineering

SAL 31.. / SAL81..

3-position actuators must have their own specific controller, refer to "Connection Diagrams" (page 10).

SAL61..

Up to 10 actuators can drive in parallel on a controller output with a rating of 1 mA. Modulating actuators have an input impedance of 100 kΩ.

Mounting

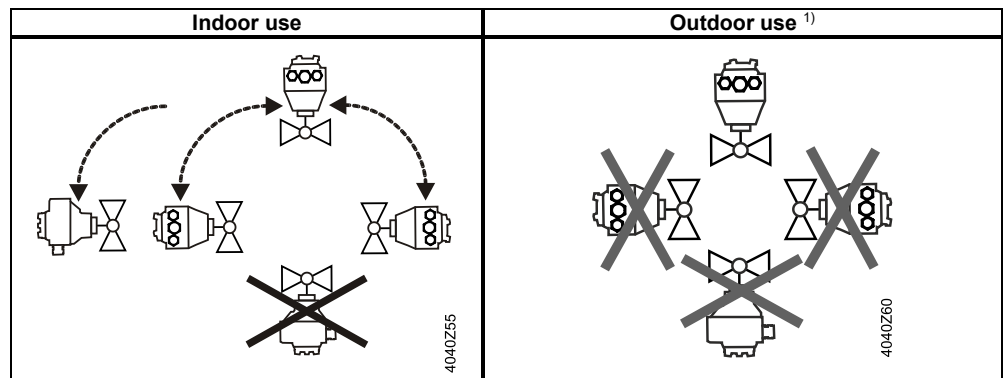

¹⁾ Only in connection with weather shield ASK39.1

Maintenance

The rotary actuators are maintenance-free.

Disposal

	<p>The device is considered electrical and electronic equipment for disposal in terms of the applicable European Directive and may not be disposed of as domestic garbage.</p> <ul style="list-style-type: none">• Dispose of the device through channels provided for this purpose.• Comply with all local and currently applicable laws and regulations.
---	---

Warranty

The engineering data specified in chapter "Combinations" (page 4) are only guaranteed in connection with the Siemens valves listed.

Note

When using the actuators in connection with slipper valves of other manufacture, correct functioning must be ensured by the user, and Siemens will assume no responsibility. The use of the rotary actuators SAL..T10.. with butterfly valves is only permitted for the Siemens Series VKF41.. and VFW41..U.

Technical Data

		SAL..
Power supply	Operating voltage SAL31.. SAL61.. SAL81..	AC 230 V ±15% AC 24 V ± 20% / DC 24 V + 20% / -15% (SELV) AC 24 V ±20% / DC 24 V + 20 % / -15% (SELV)
	Frequency	45...65 Hz
	External supply line protection (EU)	<ul style="list-style-type: none"> Fuse slow 6...10 A Circuit breaker max. 13 A, Characteristic B, C, D according to EN 60898 Power source with current limitation of max. 10 A
	Power consumption at 50 Hz	
	SAL31.00T10 Rotary actuator turns	3,5 VA / 2 W
	SAL31.00T20 Rotary actuator turns	4,5 VA / 2,75 W
	SAL31.00T40 Rotary actuator turns	7 VA / 4 W
	SAL31.03T10 Rotary actuator turns	5,5 VA / 3,25 W
	SAL31.03T10/F05 Rotary actuator turns	5,5 VA / 3,25 W
	SAL61.00T10 Rotary actuator turns	5 VA / 2,5 W
	SAL61.00T20 Rotary actuator turns	6 VA / 2,75 W
	SAL61.00T40 Rotary actuator turns	9 VA / 4 W
	SAL61.03T10 Rotary actuator turns	7,5 VA / 3,5 W
	SAL61.03T10/F05 Rotary actuator turns	7,5 VA / 3,5 W
	SAL81.00T10 Rotary actuator turns	3 VA / 2 W
	SAL81.00T20 Rotary actuator turns	4 VA / 2,75 W
	SAL81.00T40 Rotary actuator turns	6 VA / 3,75 W
	SAL81.03T10 Rotary actuator turns	5 VA / 3,5 W
	SAL81.03T10/F05 Rotary actuator turns	5 VA / 3,5 W
Function data	Positioning times (with spec. nominal angular rotation) SAL31.00..., SAL61.00..., SAL81.00	120 s
	SAL31.03T10..., SAL61.03T10..., SAL81.03T10..	30 s
	Torque SAL..T10..	10 Nm running / min. 4 Nm holding
	SAL..T20	20 Nm running / min. 14 Nm holding
	SAL..T40	40 Nm running / min. 14 Nm holding
Rotary angle	90°	
Permissible medium temperature (valve fitted)	-10...120 °C	
Signal inputs	Positioning signal "Y" SAL31..., SAL81..	3-position
	SAL31.. Voltage	AC 230 V ±15%
	SAL81.. Voltage	AC 24 V ± 20 % / DC 24 V + 20 % / -15%
	SAL61.. (DC 0...10 V) Current draw	≤ 0.1 mA
	Input impedance	≥100 kΩ
	SAL61.. (DC 4...20 mA) Current draw	DC 4...20 mA ± 1%
	Input impedance	≤500 Ω
Parallel operation	SAL61..	≤ 10 (depending on controller output)
Forced control	Positioning signal "Z" SAL61..	R = 0...1000 Ω, G, G0
	R = 0...1000 Ω	Stroke / rotation proportional to R
	Z connected to G	90° ¹⁾
	Z connected to G0	0° ¹⁾
	Voltage	Max. AC 24 V ± 20% Max. DC 24 V + 20% / -15%
	Current draw	≤ 0.1 mA
Position feedback	Position feedback U SAL61..	DC 0...10 V
	Load impedance	>10 kΩ res.
	Load	Max. 1 mA
Connecting cable	Wire cross-sectional areas	0.75...1.5 mm ² , AWG 20...16 ²⁾
Connecting cable	Cable entries	2 entries ∅ 20.5 mm (for M20)
		1 entry ∅ 25.5 mm (for M25)

Degree of protection	Housing from vertical to horizontal	IP54 as per EN 60529 ³⁾
	Insulation class SAL31.. AC 230 V SAL61.. AC / DC 24 V SAL81.. AC / DC 24 V	As per EN 60730 II III III
Environmental conditions	Operation Climatic conditions Mounting location Temperature Humidity (noncondensing)	IEC 60721-3-3 Class 3K5 Indoors (weather-protected) -15...55 °C 5...95 % r.h.
	Transport Climatic conditions Temperature Humidity	IEC 60721-3-2 Class 2K3 -25...70 °C <95 % r.h.
	Storage Climatic conditions Temperature Humidity	IEC 60721-3-1 Class 1K3 -15...55 °C 5...95 % r.h.
	Max. media temperature when mounted on valve	120 °C
Norms and Directives	Product standard	EN 60730-x
	Electromagnetic compatibility (Application)	For residential, commercial and industrial environments
	EU Conformity (CE)	CE1T4502X1 ⁴⁾
	RCM Conformity	A5W00002575 ⁴⁾
	EAC Conformity	Eurasia Conformity for all SAL..
	UL, cUL AC 230 V AC / DC 24 V	- UL 873 http://ul.com/database . File number E35198
Environmental compatibility		The product environmental declaration CE1E4502en ⁴⁾ contains data on environmentally compatible product design and assessments (RoHS compliance, materials composition, packaging, environmental benefit, disposal).
Dimensions	-	See "Dimensions" (page 11)
Weight	Excl. packaging	See "Dimensions" (page 11)

¹⁾ Observe acting direction of DIL switches

²⁾ AWG = American wire gauge

³⁾ Also with weather shield ASK39.1

⁴⁾ The documents can be downloaded from <http://siemens.com/bt/download>.

Accessories ¹⁾	Potentiometer ASZ7.5	0...1000 Ω ± 5%
		Voltage DC 10 V Current rating <4 mA
	Auxiliary switch ASC10.51	Switching capacity AC 24...230 V, 6 (2) A, floating
	External supply line protection	See section power supply
	US installation, UL & cUL	AC 24 V class 2, 5 A general purpose

¹⁾ UL recognized component 

Connection Diagrams

Internal Diagrams

SAL31..

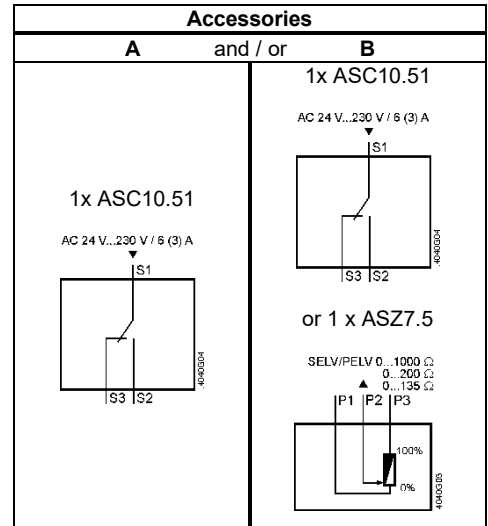
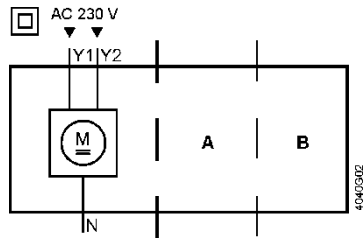

SAL61..

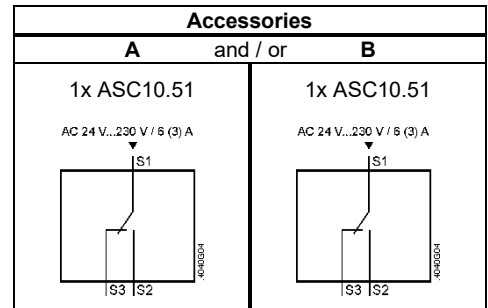
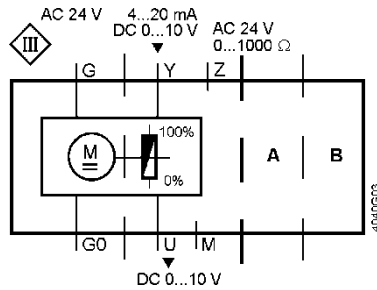

SAL81..

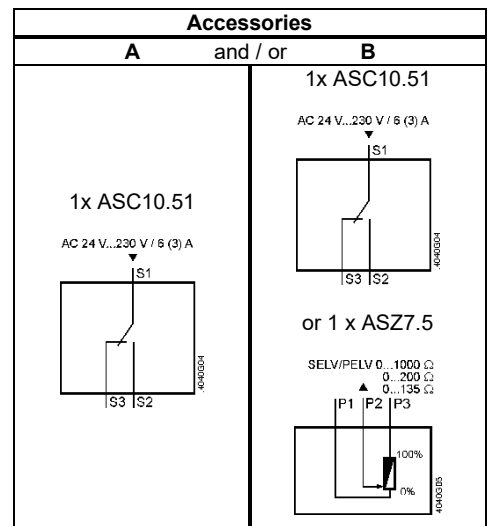
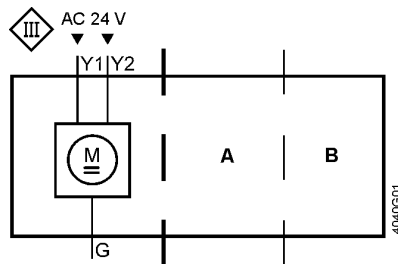

Connection terminals

SAL31..

AC 230 V, 3-position

- N** — System neutral (SN)
- Y1** — Positioning signal (actuator's spindle turns clockwise)
- Y2** — Positioning signal (actuator's spindle turns counter-clockwise)

SAL61..

AC/DC 24 V, DC 0...10 V / 4...20 mA / 0...1000 Ω

- G0** — System neutral (SN)
- G** — System potential (SP)
- Y** — Positioning signal for DC 0...10 V / 4...20 mA
- M** — Measuring neutral
- U** — Position feedback DC 0...10 V – (reference potential is M measuring neutral)
- Z** — Positioning signal forced control AC/DC ≤ 24 V, 0...1000 Ω

SAL81..

AC/DC 24 V, 3-position

- G** — System potential (SP)
- Y1** — Positioning signal (actuator's spindle turns clockwise)
- Y2** — Positioning signal (actuator's spindle turns counter-clockwise)

Connection terminals accessories

Auxiliary switch

ASC10.51

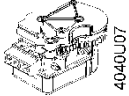

Adjustable switching points, AC 24...230 V

- 1** — System potential (SP)
- 2** — Closing (actuator's spindle turns clockwise)
- 3** — Opening (actuator's spindle turns clockwise)

AC 24 V...230 V / 6 (3) A

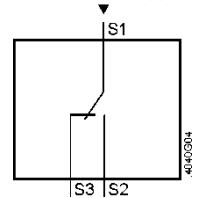

Potentiometer

ASZ7.5/..

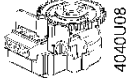

Adjustment of zero point, DC 10 V

- 1** — Measuring neutral
 - 2** — 0...x Ω
 - 3** — x...0 Ω
- x = 135 Ω, 200 Ω; 1000 Ω

SELV/PELV 0...1000 Ω
0...200 Ω
0...135 Ω

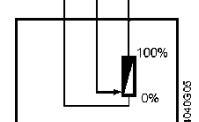

Connection Diagrams
SAL31..

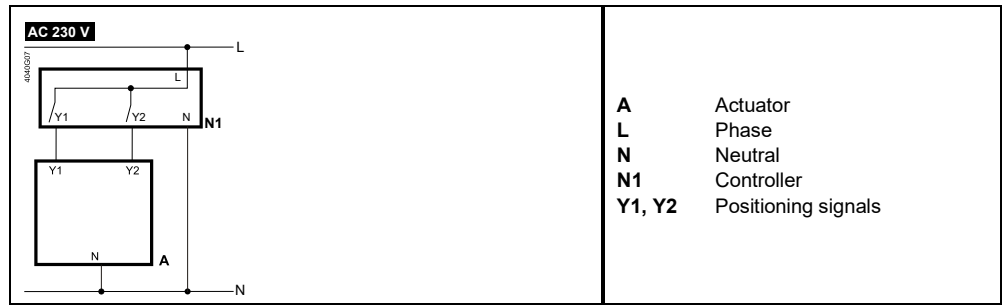

- A** Actuator
- L** Phase
- N** Neutral
- N1** Controller
- Y1, Y2** Positioning signals

SAL61..

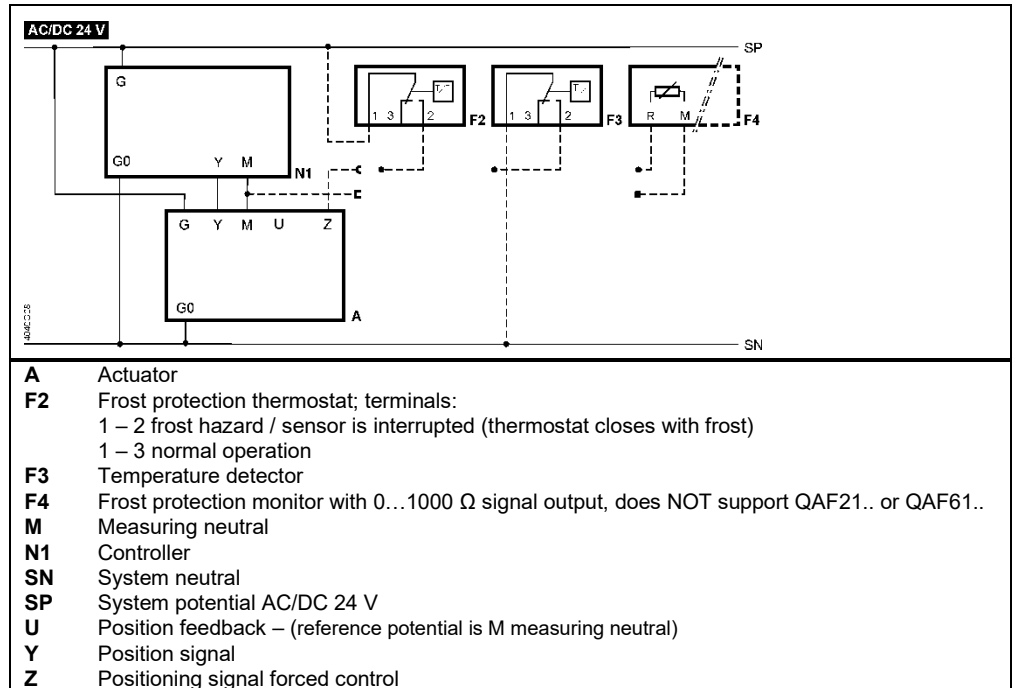

- A** Actuator
- F2** Frost protection thermostat; terminals:
1 – 2 frost hazard / sensor is interrupted (thermostat closes with frost)
1 – 3 normal operation
- F3** Temperature detector
- F4** Frost protection monitor with 0...1000 Ω signal output, does NOT support QAF21.. or QAF61..
- M** Measuring neutral
- N1** Controller
- SN** System neutral
- SP** System potential AC/DC 24 V
- U** Position feedback – (reference potential is M measuring neutral)
- Y** Position signal
- Z** Positioning signal forced control

SAL81..

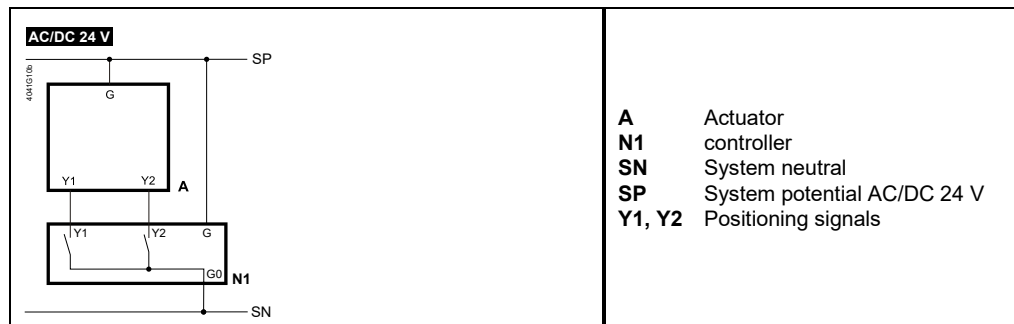

- A** Actuator
- N1** controller
- SN** System neutral
- SP** System potential AC/DC 24 V
- Y1, Y2** Positioning signals

Dimensions

Dimensions in mm

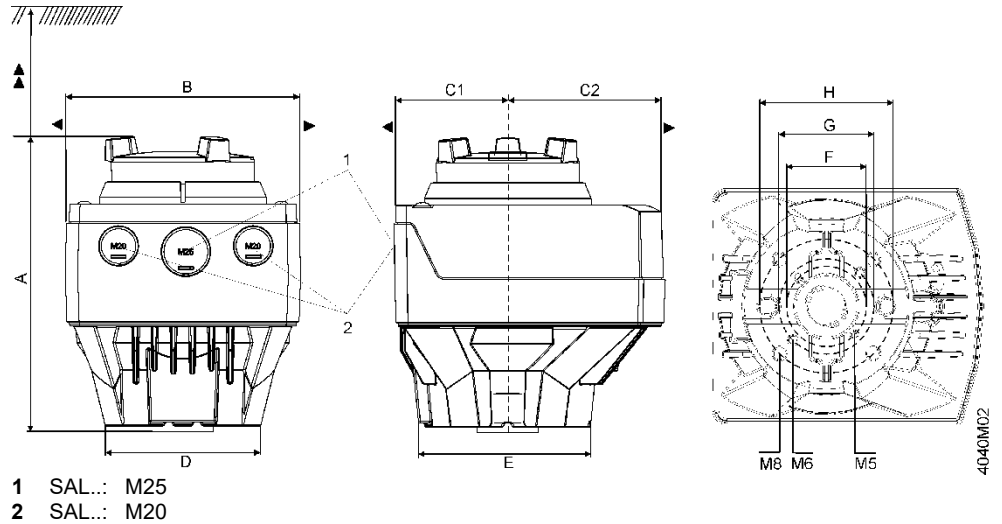

Type	A	B	C	C1	C2	D	E	F	G	H	▶	▶▶	kg		
													SAL..T10..	SAL..T20	SAL..T40
SAL..	160	124	150	68	82	82	88	42	50	70	100	200	1.475	1.600	1.625
With ASK39.1	+25	154	300	200	100	-	-	-	-	-	-	-	1.710	1.835	1.860

With mounting set ASK3..N

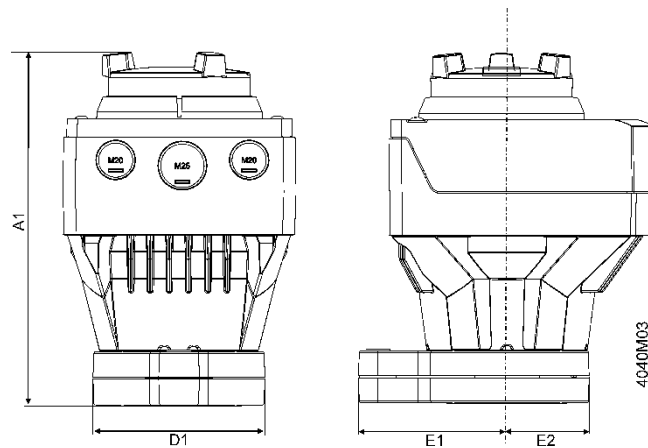

Type	A1	D1	E1	E2
SAL.. with ASK3..N	188	88	80	44
With ASK39.1	+25	-	-	-

Revision numbers

Product no.	Valid from rev. no.
SAL31.00T10	..E
SAL31.00T20	..D
SAL31.00T40	..B
SAL31.03T10	..E
SAL31.03T10/F05	..A
SAL61.00T10	..E
SAL61.00T20	..D
SAL61.00T40	..B
SAL61.03T10	..E
SAL61.03T10/F05	..A
SAL81.00T10	..E
SAL81.00T20	..D
SAL81.00T40	..B
SAL81.03T10	..E
SAL81.03T10/F05	..A

Issued by
Siemens Switzerland Ltd
Smart Infrastructure
Global Headquarters
Theilerstrasse 1a
6300 Zug
Switzerland
Tel. +41 58-724 24 24
www.siemens.com/buildingtechnologies

© Siemens Switzerland Ltd, 2011
Technical specifications and availability subject to change without notice.