



OpenAir™

Air damper actuators

GQD...1

Rotary version, AC/DC 24 V and AC 230 V

GQD...1

- Electric motor-driven actuators for two-position and three-position control as well as DC 0...10 V control
- 2 Nm nominal torque
- AC/DC 24 V or AC 230 V rated voltage
- Prewired with 0.9 m connecting cable
- Spring return
- Auxiliary switch for auxiliary functions

Use

- For damper areas up to 0.3 m², friction dependent.
- For directly driven zone dampers to control air flow in air ducts.

Type summary



Spring return rotary actuators GQD	Type	Operating voltage	Control signal	Cable length	Coupling	Auxiliary switch
	GQD121.1A	AC/DC 24 V	2-position	0.9 m	8...15 mm	-
	GQD126.1A	AC/DC 24 V	2-position	0.9 m	8...15 mm	yes
	GQD321.1A	AC 230 V	2-position	0.9 m	8...15 mm	-
	GQD326.1A	AC 230 V	2-position	0.9 m	8...15 mm	yes
	GQD131.1A	AC 24 V / DC 24...48 V	3-position	0.9 m	8...15 mm	-
	GQD136.1A	AC 24 V / DC 24...48 V	3-position	0.9 m	8...15 mm	yes
	GQD161.1A	AC 24 V / DC 24...48 V	DC 0...10 V	0.9 m	8...15 mm	-
	GQD166.1A	AC 24 V / DC 24...48 V	DC 0...10 V	0.9 m	8...15 mm	yes

Functions

Type	GQD121.1A GQD126.1A GQD321.1A GQD326.1A	GQD131.1A GQD136.1A	GQD161.1A GQD166.1A
Control type	2-position	3-position	DC 0...10 V
Direction of rotation	Clockwise or counter-clockwise movement depends on the actuator's mounting position on the damper shaft...		
	-	...as well as the type of control	-
Spring return	On power failure or when the operating voltage is switched off, the spring return moves the rotary actuator to its mechanical zero position.		
Auxiliary switch	GQD...6.1A: Set switching points at 5° or 85°.		

Technical data

⚠ Power supply AC/DC 24 V	Operating voltage AC / frequency	AC 24 V ± 20% ; 50 / 60 Hz	
	Operating voltage DC	DC 24 V ± 15%	
⚠ Supply voltage AC 24 V DC 24...48 V	Power consumption		
	GQD121.1A / GQD126.1A: (running)	6.5 VA / 4.5 W	
	(holding)	4 VA / 2.5 W	
	Operating voltage AC / frequency		AC 24 V ± 20% ; 50/60 Hz
	Operating voltage DC		DC 24...48 V ± 20%
	Power consumption		
- GQD131.1A / GQD136.1A: (running)	4 VA / 2.5 W		
(holding)	3 VA / 1.5 W		
- GQD161.1A / GQD166.1A: (running)	4.5 VA / 3 W		
(holding)	3.5 VA / 2 W		
Safety extra-low voltage (SELV) or Protective extra-low voltage (PELV) as per Requirements for external safety isolating		HD 384	

⚠ Supply voltage AC 230 V	transformer (100% duty cycle)	EN 61 558
	Fuse for incoming supply line (fast)	2 A
Functional data	Operating voltage / Frequency	AC 230 V ± 15%; 50 / 60 Hz
	Fuse for incoming supply line (fast)	2 A
	Power consumption	
	GQD321.1A / GQD326.1A: (running)	10 VA / 4.5 W
	(holding)	7 VA / 3 W
	Nominal torque	2 Nm
	Maximum torque	6 Nm
	Nominal rotational angle	90°
	Maximum rotational angle (mechanically limited)	95 ± 2°
	Runtime at nominal rotational angle 90°	30 s
	Closing time with spring return (on power failure)	15 s
	Duty cycle	100%
Direction of rotation	Clockwise/counter-clockwise	
Mechanical life	60 000 cycles	
Positioning signal for GQD131.1A / GQD136.1A	Contact voltage	AC 24 V / DC 24...48 V or AC 0 V
	Contact current	8 mA typical
Positioning signal for GQD161.1A / GQD166.1A	Input voltage Y (max.)	DC 0...35 V
	Working range Y	DC 0...10 V
Auxiliary switch	AC power	
	– Switching voltage	AC 24...230 V
	– Rated voltage resistive / inductive	6 A / 2 A
	No mixed operation AC 24 V / 230 V	
	DC power	
	– Switching voltage	DC 12...30 V
	– Rated current	DC 2 A
	Factory switch setting	
– Switch A (set)	5°	
– Switch B (set)	85°	
Connection cables	Cable length	0.9 m
	Cross-section	0.75 mm ²
Housing type	Protection as per EN 60 529	IP40
Protection class	Insulation protective class	EN 60 730
	– AC 230 V	
	– AC/DC 24 V	
Environmental conditions	Operation	IEC 721-3-3
	– Climatic conditions	Class 3K5
	– Mounting location	Interior, weather-protected
	– Temperature (extended)	-32...+55 °C
	– Humidity, non-condensing	< r.h. 95%
	Transportation	IEC 721-3-2
	– Climatic conditions	Class 2K3
	– Temperature (extended)	-32...+70 °C
	– Humidity, non-condensing	< 95% r.h.
	Storage	IEC 721-3-1
	– Climatic conditions	Class 1K3
	– Temperature (extended)	-32...+50 °C
– Humidity, non-condensing	< 95% r.h.	
Mechanical conditions	Class 2M2	

Standards	Product safety	
	Automatic electrical controls for household and similar use	IEC/EN 60 730-2-14 (Type 1)
	Electromagnetic compatibility (Application)	For residential, commercial and industrial environments
	EU Conformity (CE)	A5W00004364 ¹⁾
	RCM Conformity	A5W00004365 ¹⁾
Dimensions	Product environmental declaration ²⁾	CM2E4604E ¹⁾
	Actuator	
	W × H × D	See "Dimensions"
	Damper shaft	
	– Rectangular	6...11 mm
	Min. length	20 mm
	Max. shaft hardness	300 HV
– Round	8...15 mm	
Min. length	20 mm	
Max. shaft hardness	300 HV	
Weight	Excl. packaging	
	– GQD121.1A	0.480 kg
	– GQD126.1A	0.600 kg
	– GQD321.1A	0.490 kg
	– GQD326.1A	0.615kg
	– GQD131.1A	0.500 kg
	– GQD136.1A	0.620 kg
	– GQD161.1A	0.500 kg
	– GQD166.1A	0.620 kg

¹⁾ The documents can be downloaded from <http://siemens.com/bt/download>

²⁾ The product environmental declaration contains data on environmentally compatible product design and assessments (RoHS compliance, materials composition, packaging, environmental benefit, disposal).

Mechanical design

Basic components

Housing	Fiberglass-reinforced plastic
Gear train	Maintenance-free, noise-free

Safety

	<p>⚠ Caution</p>
	<p>National safety regulations</p> <p>Failure to comply with national safety regulations may result in personal injury and property damage.</p> <ul style="list-style-type: none"> • Observe national provisions and comply with the appropriate safety regulations. • Use only properly trained technicians for mounting, commissioning, and servicing.

STOP

This section explains general and system-specific regulations for mains and operating voltages. It also contains important information on your own safety and that of your plant.

Intended use

Use these actuators as described in the basic system documentation for the applied control systems. In addition, take account of all actuator-specific features and conditions as described in the brief description on the front page of this data sheet (bold print) as well as the sections "Use", "Engineering notes", and "Technical data".



Sections flagged with the warning symbol to the left contain safety-related requirements and restrictions that must be adhered to at all times to prevent physical injury and equipment damage.

⚠ AC/DC 24 V supply

Operate the actuators only on safety extra-low voltage (SELV) or protective extra-low voltage (PELV) as per HD 384.

⚠ AC 230 V supply

The actuators are double-insulated and there is no connection for the protective ground.

⚠ Auxiliary switch

Apply only mains voltage or protective extra-low voltage to the switching outputs of the auxiliary switch. Mixed operation is not allowed. Operation at various phases is not allowed.

CAUTION

Do not open the actuators!

- The actuators are maintenance-free.
- Only the manufacturer may carry out repair work.
- Opening the actuator will void the warranty.
- Spring-return actuators contain pretensioned springs. Only trained staff may open this type of actuator (special tools required).

Electric, parallel connection of actuators

Up to 10 actuators of the same type can be electrically wired in parallel; cable length and cable cross-sections must be observed.

Required actuator type

Selection of the actuator depends on several torque factors. After obtaining the damper torque rating (Nm/m²) from the manufacturer and determining the damper area, calculate the total torque required to move the damper as follows:

Spring return damper actuators:

IF total torque (SF ¹):	Use type:
≤ 2 Nm	GQD...1.1A / GQD...6.1.A (2 Nm)
≤ 7 Nm	GMA...1 (7 Nm)
≤ 18 Nm	GCA...1 (18 Nm)

¹ Safety factor SF: When calculating the required torque, non-definable variables such as slight misalignment, damper age, etc. must be included as a safety factor. We recommend a safety factor of 0.8 (or 80 % of the torque characteristic).

Transformer sizing for AC 24 V

Use safety insulating transformers as per EN 61 558 with double insulation designed for 100 % duty to supply SELV or PELV circuits..

Observe all local safety rules and regulations pertaining to the sizing and protection of transformers.

Determine the transformer power consumption by adding up the power consumption in VA for all actuators used.

Wiring and commissioning Refer to the sections "Commissioning notes" and "Wiring diagrams" in this data sheet as well as to the HVAC job drawings.

Mounting notes

Mounting instructions All information and steps to properly prepare and mount the actuator are listed in the mounting instructions supplied with the actuator.

Mounting position Mount the actuator in a position which ensures easy access to the cables and to the shaft adapter. See "Dimensions".

Damper shafts Information on minimum length and diameter for the damper shaft is available in the "Technical data" section.

Disposal



The device is considered an electronics device for disposal in terms of European Directive 2012/19/EU and may not be disposed of as domestic garbage.

- Dispose of the device through channels provided for this purpose.
- Comply with all local and currently applicable laws and regulations.

Commissioning notes

Reference For commissioning, the following reference documentation must be available::

- This data sheet.
- HVAC job diagram.

Environmental conditions Check to ensure that all permissible values as contained in the section "Technical data" have been observed.

Mechanical check

- Check for proper mounting and ensure that all mechanical settings correspond to the plant-specific requirements. Additionally, ensure that the dampers are tightly closed when in the closed position.
- Check the direction of rotation.
- Fasten the actuator securely to avoid twisting and blocking of the actuator.

Electrical check

- Check to ensure that the cables are connected in accordance with the plant wiring diagram (see "Wiring diagrams").
- The operating voltage AC/DC 24 V (SELV/PELV) or AC 230 V must be within the tolerance values.

Functional check

GQD121.1A Power supply AC/DC 24 V wires red (1), black (2)
GQD126.1A

- Supply ON: Actuator turns clockwise
- Supply OFF: Actuator runs counter-clockwise (mechanical, via spring)

GQD321.1A Power supply AC 230 V wires brown (3), blue (4)
GQD326.1A

- Supply ON: Actuator turns clockwise
- Supply OFF: Actuator runs counter-clockwise (mechanical, via spring)

- GQD131.1A
GQD136.1A
- Power supply AC 24 V / DC 24...48 V wires red (1), black (2)
Positioning signal AC 24 V / DC 24...48 V or AC 0 V
- Wire violet (6) ON: Actuator turns clockwise
 - Wire orange (7) ON: Actuator turns counter-clockwise
 - Wire violet (6) and wire orange (7) ON: Actuator turns counter-clockwise
 - Wire violet (6) and wire orange (7) OFF: Actuator stops
 - Supply OFF: Actuator runs counter-clockwise (mechanical, via spring)
- GQD161.1A
GQD166.1A
- Power supply AC 24 V / DC 24...48 V wires red (1), black (2)
Positioning signal DC 10 V
- Wire gray (8) ON: Actuator turns clockwise
 - Wire gray (8) OFF: Actuator turns counter-clockwise (electric)
 - Supply OFF: Actuator runs counter-clockwise (mechanical, via spring)

Wiring diagrams

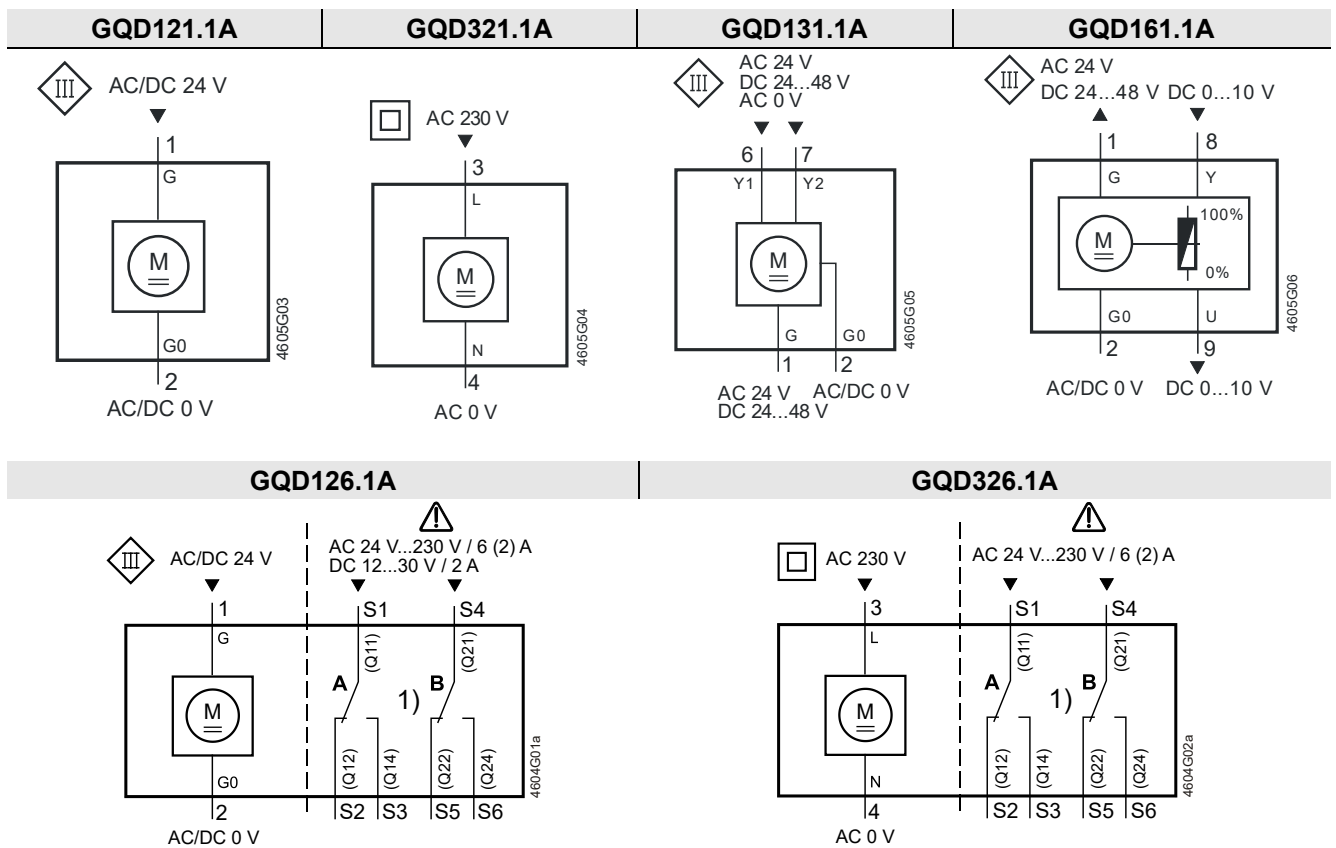

GQD136.1A

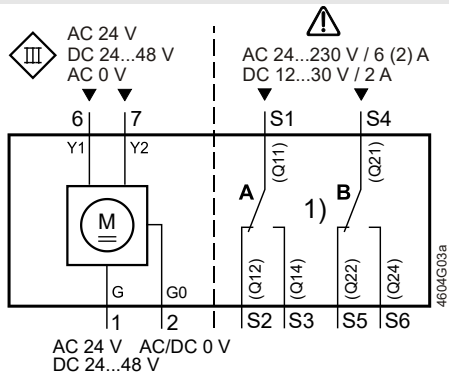

GQD166.1A

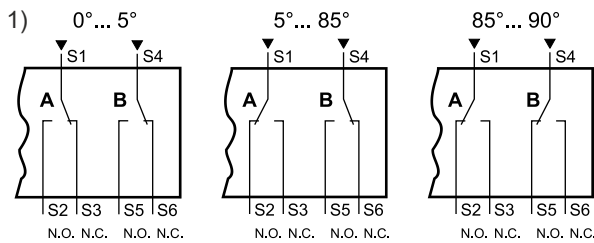
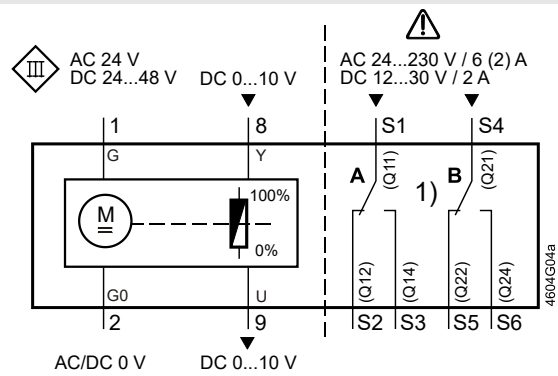

Actuator Position	Switch A Common S1 connected to	Switch B Common S4 connected to
0°...5°	S3	S6
5°...85°	S2	S6
85°...90°	S2	S5

Cable labeling

Connection	Cable				Description
	Code	No.	Color	Abbr.	
GQD121.1A	G	1	red	RD	System potential AC/DC 24 V
GQD126.1A AC/DC 24 V	G0	2	black	BK	System neutral
GQD321.1A	L	3	brown	BN	Phase AC 230 V
GQD326.1A AC 230 V	N	4	blue	BU	Neutral conductor
GQD131.1A	G	1	red	RD	System potential AC 24 V / DC 24...48 V
GQD136.1A	G0	2	black	BK	System neutral
AC 24 V	Y1	6	violet	VT	Positioning signal clockwise AC 24 V / DC 24...48 V or AC 0 V
DC 24...48 V	Y2	7	orange	OG	Positioning signal clockwise AC 24 V / DC 24...48 V or AC 0 V
GQD161.1A	G	1	red	RD	System potential AC 24 V / DC 24...48 V
GQD166.1A	G0	2	black	BK	System neutral
AC 24 V	Y	8	gray	GY	Positioning signal DC 0...10 V
DC 24...48 V	U	9	pink	PK	Position indication DC 0 ... 10 V
Aux. switch	Q11	S1	gray/red	GYRD	Switch A input
	Q12	S2	gray/blue	GYBU	Switch A normally open contact
	Q14	S3	gray/pink	GYPK	Switch A normally closed contact
	Q21	S4	black/red	BKRD	Switch B input
	Q22	S5	black/blue	BKBU	Switch B normally open contact
	Q24	S6	black/pink	BKPK	Switch B normally closed contact

Dimensions

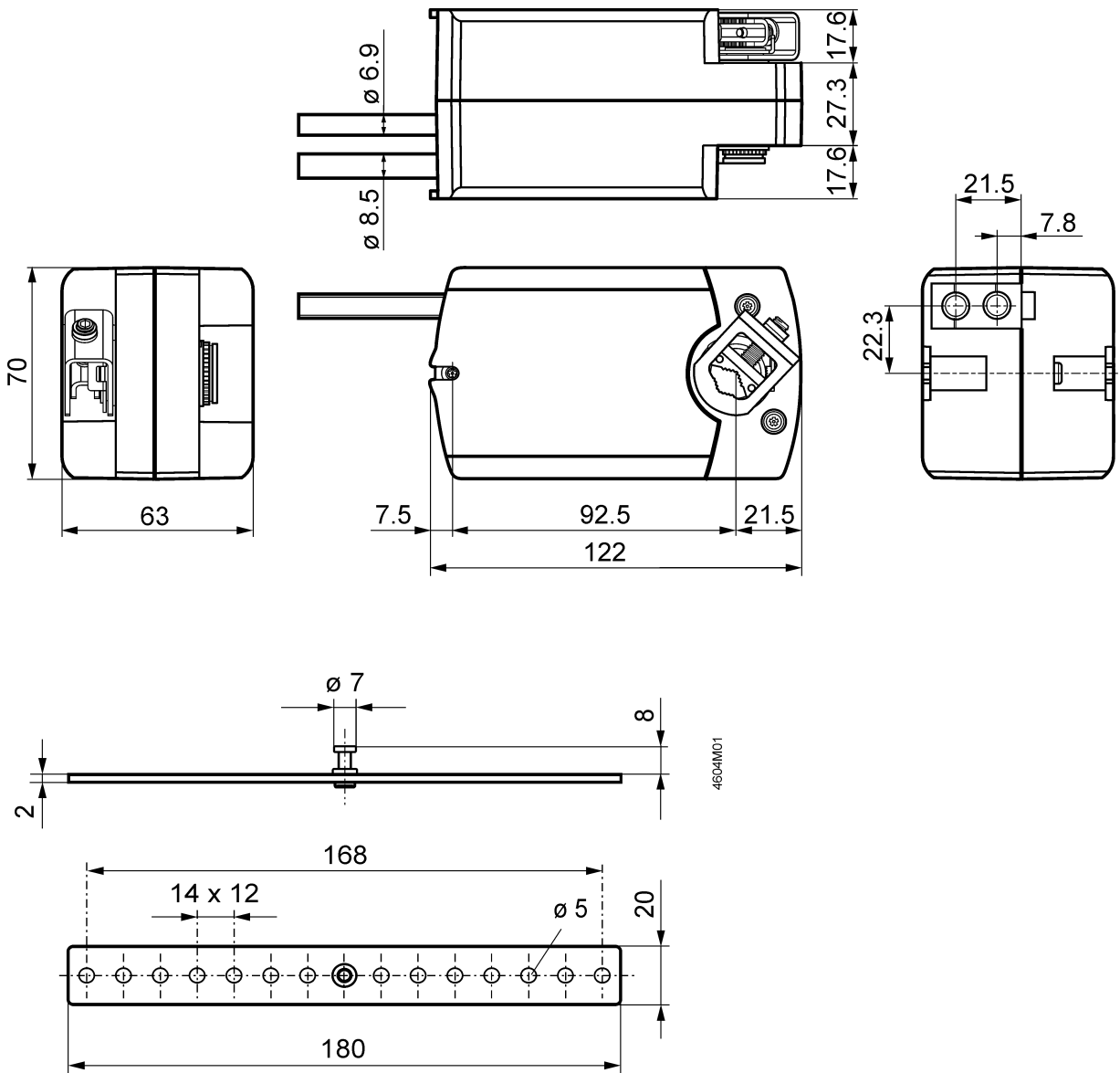

Issued by
Siemens Switzerland Ltd
Smart Infrastructure
Global Headquarters
Theilerstrasse 1a
CH-6300 Zug
+41 58 724-2424
www.siemens.com/buildingtechnologies

© Siemens Switzerland Ltd, 2010
Technical specifications and availability subject to change without notice.