

OpenAir™

Accessories and Spare Parts for Air Damper Actuators

ASC... ASK...

Overview, functions and applications for GCA, GGA, GBB and GIB

This overview provides a list of the accessories to functionally enhance the GCA, GGA, GBB, and GIB air damper actuators as well as a list of the spare parts for the actuators.

Application examples and important dimensions are contained in the respective mounting installations (see document no.).

Accessories for rotary actuators

Type document no. (classification no.)	Designation / scope of delivery	Use	
		For actuator type	Function
ASK71.1 431926590 (M4626.1)	Rotary/linear set for duct mounting (with mounting plate, external bearing) 	GCA...1 GGA...1 GBB...1 GIB...1	<ul style="list-style-type: none"> To convert rotary to linear movement for duct mounting Ball joints for push rod 8 mm dia. Not suited for GIB actuators <ul style="list-style-type: none"> If the end stop is provided by the air damper

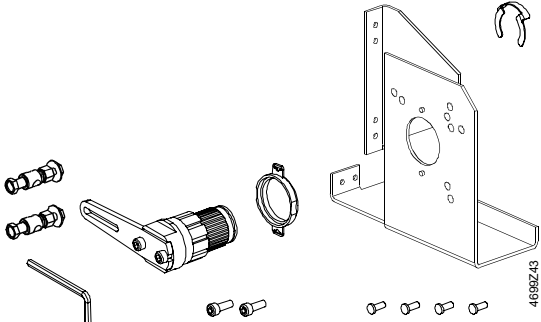
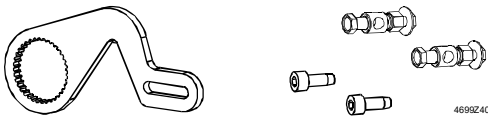
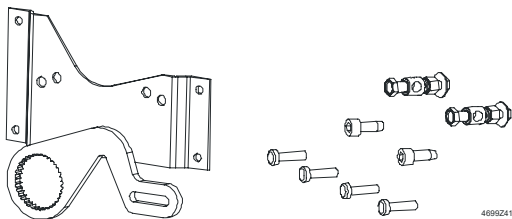
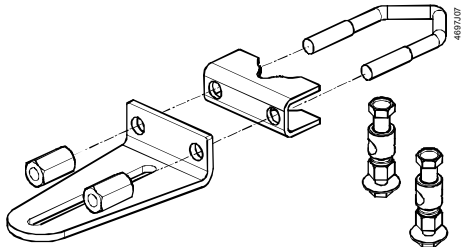
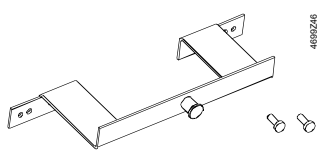
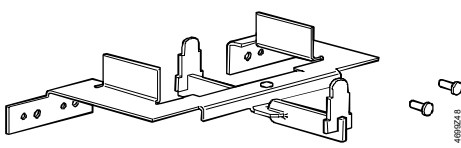
Type document no. (classification no.)	Designation / scope of delivery	Use	
		For actuator type	Function
ASK71.2 431927080 (M4626.2)	Rotary/linear set for frame mounting (with mounting plate, external bearing) 	GCA...1 GGA...1 GGB...1 GIB...1	<ul style="list-style-type: none"> To convert rotary to linear movement for frame (wall) mounting Ball joints for push rod 8 mm dia. Not suited for GIB actuators <ul style="list-style-type: none"> If the end stop is provided by the air damper
ASK71.3 431927250 (M4626.3)	Rotary/linear set with lever 		<ul style="list-style-type: none"> To convert rotary to linear movement. Suited for <ul style="list-style-type: none"> direct duct or wall mounting of the actuator via rear mounting Damper mounting for actuator with additional rotary/linear function Ball joints for push rod 8 mm dia.
ASK71.4 431928460 (M4626.4)	Rotary/linear set with lever and mounting plate 		<ul style="list-style-type: none"> To convert rotary to linear movement Mounting the actuator on the mounting plate allows for actuator-side duct or frame mounting Ball joints for push rod 8 mm dia.
ASK71.9 7431902360 (M4614.1)	Universal lever 	GCA... GGA... GGB... GIB...	<ul style="list-style-type: none"> To convert linear to rotary movement, for mounting on an adjacent damper shaft Can be used in connection with ASK71.1 to ASK71.4 Ball joints for push rod 8 mm dia.
ASK73.1 431928490 (M4613.1)	Bracket for powerpack 	GCA12..1 GCA32..1 GCA13..1 GGA12..1 GGA32..1 GIB13..1 GIB33..1	<ul style="list-style-type: none"> As locking element for two rotary actuators on the same shaft (tandem mounted) Powerpack is permitted only with two- or three-position control actuators providing
ASK73.2 431929500 (M4613.2)	Self-aligning bracket for powerpack 	GCA16..1 GGA16..1 GIB16..1	<ul style="list-style-type: none"> Serves as a self-aligning bracket with two rotary actuators on the same shaft (tandem mounted) This self-aligning bracket has been designed only for actuators with modulating control Not suited for GIB actuators <ul style="list-style-type: none"> If the end stop is provided by the air damper

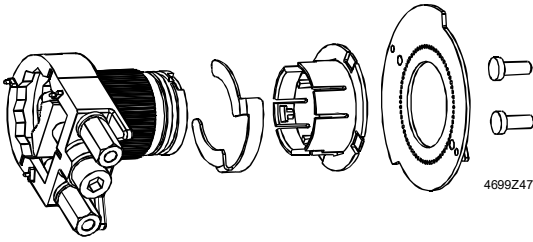
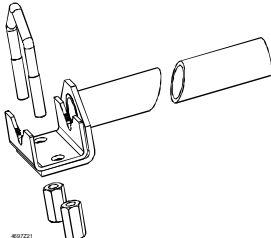
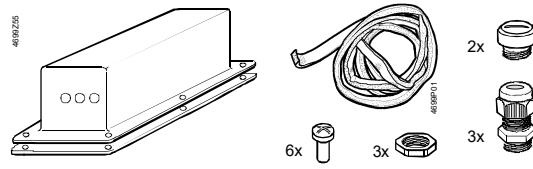
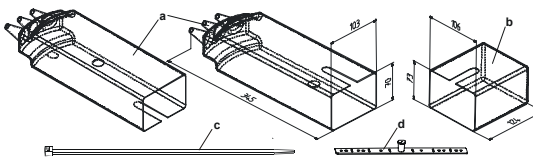
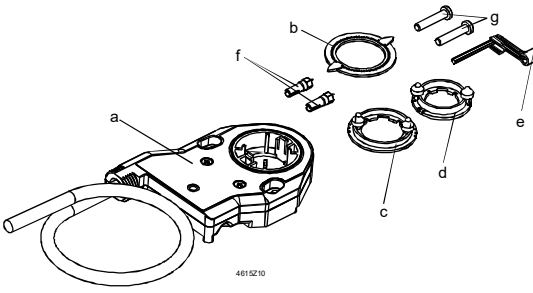
Type document no. (classification no.)	Designation / scope of delivery	Use	
		For actuator type	Function
ASK74.1 471814060	Special shaft adapter 	GCA...1 GGA...1 GBB...1 GIB...1	This shaft adapter <ul style="list-style-type: none"> allows for centered mounting is suitable for shafts of 15...26.5 mm dia. stays for all mounting positions within the side profile of the actuator exceeds the actuator length less than the standard shaft adapter is not suited for GIB actuators <ul style="list-style-type: none"> if the end stop is provided by the air damper
ASK74.7	Shaft extension 		<ul style="list-style-type: none"> For extending the drive shaft by up to approx. 240 mm. For drive shafts of 8...25.6 mm dia. or 6...18 mm square Minimum shaft length 40 mm Can not be used in connection with ASK73.1 or ASK73.2
ASK75.1 431929460 (M4626.11)	Weather shield for rotary actuator 		<ul style="list-style-type: none"> Provides additional protection of the rotary actuator against dust and splash-water in the case of outdoor use. UV-resistant
ASK75.4 7431906410 (M4626.12)	Weather shield for rotary actuator 		<ul style="list-style-type: none"> Provides additional protection to rotary actuator and when mounting in any given position
ASC77.1E ASC77.2E 7431904130 (M4615)	External auxiliary switches 		<ul style="list-style-type: none"> ASC77.1E (1 switch) ASC77.2E (2 switches)

Accessories for linear actuators

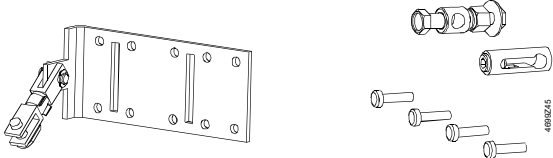
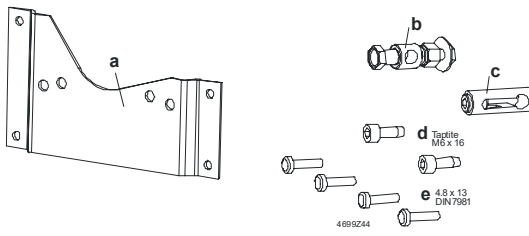
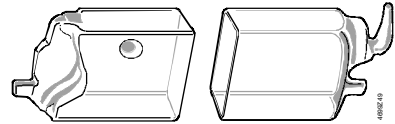

Type document no. (classifikation no.)	Designation / scope of delivery	Use	
		For actuator type	Function
ASK72.1 431927240 (M4656.1)	Linear/rotary set (with cardan joint) 	GBB...2	<ul style="list-style-type: none"> To convert linear to rotary movement Mounting the actuator together with the linear set allows for cardanic suspension, can be swiveled on two levels Linear limitation by adjusting the clamp on the push rod Ball joints for push rod 8 mm dia.
ASK72.2 431928480 (M4656.2)	Linear/rotary set with mounting plate 		<ul style="list-style-type: none"> To convert linear into rotary movement Mounting the actuator on the mounting plate allows for actuator-side frame or duct mounting Linear limitation by adjusting the clamp on the push rod Ball joints for push rod 8 mm dia.
ASK75.2 431929470 (M4656.3)	Weather shield for linear actuator 	GBB161.2 GBB163.2 GBB131.2 GBB331.2	<ul style="list-style-type: none"> Provides additional protection to linear actuator and when mounting in any given position Only for actuator types with one cable

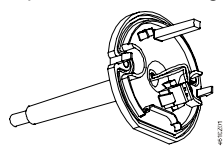
Actuators for fire and smoke protection dampers

Type Document no. (Classific. no.)	Designation / Delivery	Application	
		Actuator	Function
ASK79.4 ASK79.5 7431908350 (M4610)	Duct tip for temperature monitoring unit 	GGA..	<ul style="list-style-type: none"> ASK79.4 (72 °C) ASK79.5 (95 °C)

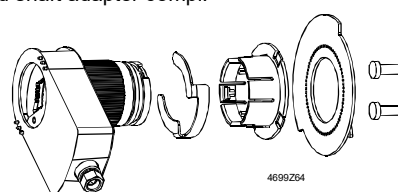
Spare parts for rotary actuators

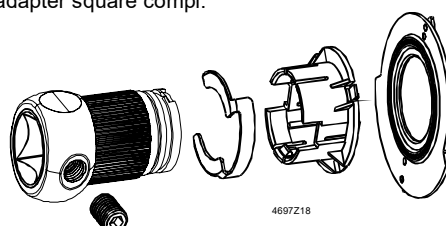
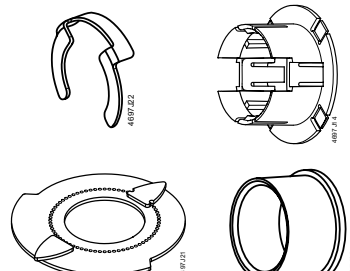
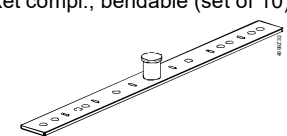
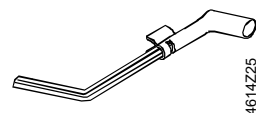
Spare part-number	Designation / delivery	Application	
		Actuator	Function
ASK71.06 (S55859-Z117)	Standard shaft adapter compl. 	GCA...1 GGA...1 GBB...1 GIB...1	<p>This shaft adapter is</p> <ul style="list-style-type: none"> self-centering suited for shafts of 8...25.6 mm dia.

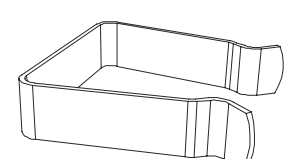
Spare part number	Designation / delivery	Application	
		For actuator type	Function
ASK74.17 (S55859-Z108)	Shaft adapter square compl. 	GCA...1	15 mm
ASK74.18 (S55859-Z109)		GGA...1	12 mm
ASK74.19 (S55859-Z110)		GBB...1	10 mm
ASK74.20 (S55859-Z111)		GIB...1	8 mm
ASK71.02 (S55859-Z102)	Accessory kit 		<p>Consisting of:</p> <ul style="list-style-type: none"> • Axial bracket Fixes axle adapter in the actuator. • Plastic adapter with position indicator Required on short damper shafts (< 20 mm). It is inserted into the shaft adapter and carries the position indicator. • Position indicator It is clamped on the shaft adapter or the plastic adapter and indicates the air damper rotational angle of the air damper. • Plug indicator Fixes the position indicator onto the plastic adapter.
ASK71.03 (S55859-Z114)	Mounting bracket compl., bendable (set of 10) 		The mounting bracket is used to prevent the actuator from twisting and is secured with 2 steel screws (4.8 x 13 mm, DIN 7981).
ASK71.19 (S55859-Z121)	Turnkey for manual adjustment (set of 10) 	GCA...1 GGA...1	Manual adjustment for the shaft adapter.
418023780	Screw taptite M6 x 16 mm 	GCA...1 GGA...1	Self-tapping screw to fasten the actuator on the mounting, duct or wall plate.
421711320	Fork clamp 	GBB...1 GIB...1	
			The fork clamp is used to prevent the actuator from twisting.

Issued by
Siemens Switzerland Ltd
Smart Infrastructure
Global Headquarters
Theilerstrasse 1a
6300 Zug
Switzerland
Tel. +41 58-724 24 24
www.siemens.com/buildingtechnologies

© Siemens Switzerland Ltd, 2015
Technical specifications and availability subject to change without notice.