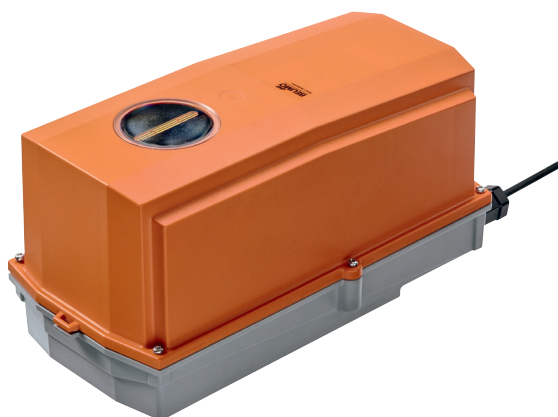

Rotary actuator for butterfly valves

- Torque motor Max. 90 Nm (not constant)
- Nominal voltage AC 230 V
- Control Open/close
- Running time motor 35 s
- Optimum weather protection for use outdoors

Technical data

Electrical data	Nominal voltage	AC 230 V
	Nominal voltage frequency	50/60 Hz
	Nominal voltage range	AC 85...265 V
	Power consumption in operation	6 W
	Power consumption in rest position	2 W
	Power consumption for wire sizing	11 VA
	Connection supply / control	Cable 1 m, 3 x 0.75 mm ² (halogen-free)
	Parallel operation	Yes (note the performance data)
Functional data	Torque motor	Max. 90 Nm (not constant)
	Manual override	with push-button, can be locked
	Running time motor	35 s / 90°
	Sound power level, motor	35 dB(A)
	Position indication	Yes
Safety	Protection class IEC/EN	II reinforced insulation
	Protection class UL	II reinforced insulation
	Degree of protection IEC/EN	IP66/67
	Degree of protection NEMA/UL	NEMA 4X
	Enclosure	UL Enclosure Type 4X
	EMC	CE according to 2014/30/EU
	Low voltage directive	CE according to 2014/35/EU
	Certification IEC/EN	IEC/EN 60730-1 and IEC/EN 60730-2-14
	Mode of operation	Type 1
	Rated impulse voltage supply / control	2.5 kV
	Control pollution degree	4
	Ambient temperature	-30...50 °C
	Ambient temperature note	-40...50 °C for actuator with integrated heating
	Storage temperature	-40...80 °C
	Ambient humidity	Max. 100% r.H.
Servicing	maintenance-free	
Mechanical data	Connection flange	F05
Weight	Weight	5.8 kg

Safety notes



- This device has been designed for use in stationary heating, ventilation and air-conditioning systems and must not be used outside the specified field of application, especially in aircraft or in any other airborne means of transport.
- Caution: Power supply voltage!
- Only authorised specialists may carry out installation. All applicable legal or institutional installation regulations must be complied during installation.
- Junction boxes must at least correspond with enclosure IP degree of protection!
- The cover of the protective housing may be opened for adjustment and servicing. When it is closed afterwards, the housing must seal tight (see installation instructions).
- The switch for changing the direction of rotation may not be adjusted.
- The angle of rotation is not permitted to be subjected to mechanical limitation. It is forbidden to alter the mechanical end stops.
- The device may only be opened at the manufacturer's site. It does not contain any parts that can be replaced or repaired by the user.
- The device contains electrical and electronic components and must not be disposed of as household refuse. All locally valid regulations and requirements must be observed.
- The actuator is not designed for applications where chemical influences (gases, fluids) are present or for utilisation in corrosive environments in general.
- The actuator may not be used in plenary applications (e.g. suspended ceilings or raised floors).
- The materials used may be subjected to external influences (temperature, pressure, construction fastening, effect of chemical substances, etc.), which cannot be simulated in laboratory tests or field trials. In case of doubt, we definitely recommend that you carry out a test. This information does not imply any legal entitlement. Belimo will not be held liable and will provide no warranty.
- Flexible metallic cable conduits or threaded cable conduits of equal value are to be used for UL (NEMA) Type 4X applications.
- When used under high UV loads, e.g. extreme sunlight, the use of flexible metallic or equivalent cable conduits is recommended.

Product features

Fields of application	The actuator is particularly suitable for utilisation in outdoor applications and is protected against the following weather conditions: <ul style="list-style-type: none"> - UV radiation - Rain / Snow - Dirt / Dust - Air humidity - Alternating climate / frequent and severe temperature fluctuations (Recommendation: use the actuator with integrated factory-installed heating which can be ordered separately to prevent internal condensation)
Simple direct mounting	Simple direct mounting on the butterfly valve. The mounting orientation in relation to the butterfly valve can be selected in 90° (angle) increments.
Manual override	Manual override with push-button possible (the gear is disengaged for as long as the button is pressed or remains locked). The housing cover must be removed for manual override.
High functional reliability	The actuator is overload protected, requires no limit switches and automatically stops when the end stop is reached.
Combination valve/actuator	For valves with the following mechanical specifications in accordance with ISO 5211 F05: <ul style="list-style-type: none"> - Square stem head SW = 14 mm for form-fit coupling of the rotary actuator. - Hole circle d = 50 mm

Product features

Torque not constant Due to the non-linear torque characteristic the actuator can only be used for butterfly valves and not for other armatures.

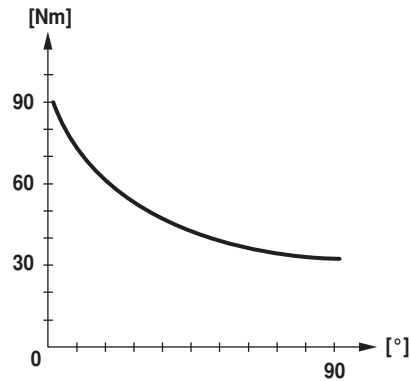

Accessories

	Description	Type
Electrical accessories	Auxiliary switch 2 x SPDT add-on, grau	S2A GR
	Feedback potentiometer 140 Ω add-on	P140A
	Feedback potentiometer 200 Ω add-on	P200A
	Feedback potentiometer 500 Ω add-on	P500A
	Feedback potentiometer 1 kΩ add-on	P1000A
	Feedback potentiometer 2.8 kΩ add-on	P2800A
	Feedback potentiometer 5 kΩ add-on	P5000A
	Feedback potentiometer 10 kΩ add-on	P10000A

Electrical installation



Notes • Caution: Power supply voltage!

Wiring diagrams

AC 230 V, open/close

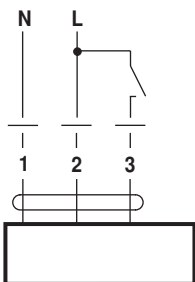

Cable colours:

1 = blue
2 = brown
3 = white

Dimensions [mm]

Dimensional drawings

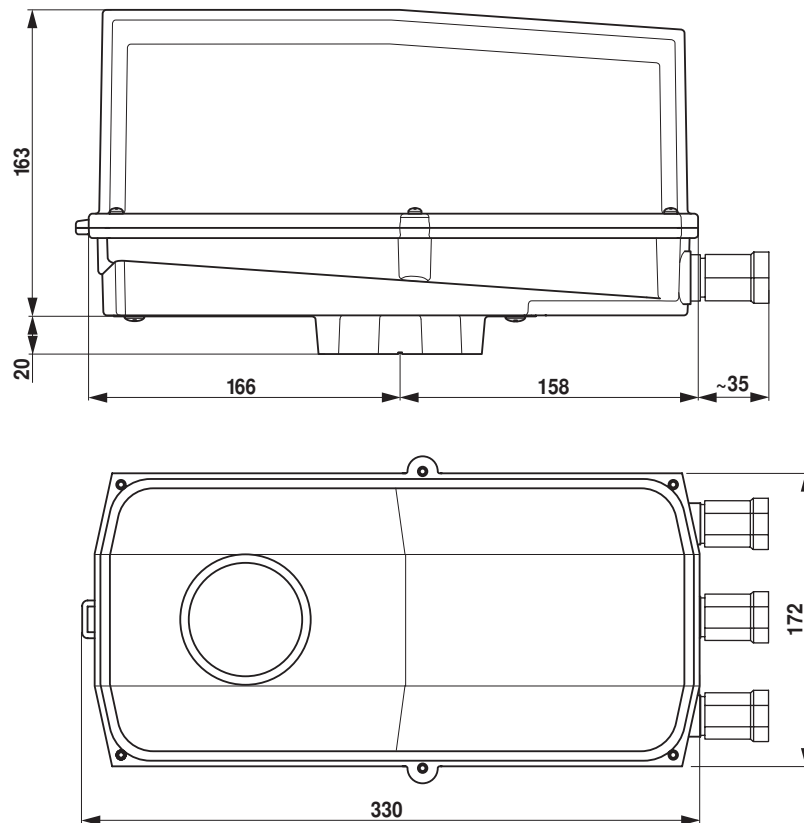

Further documentation

- The complete product range for water applications
- Data sheets for butterfly valves
- Installation instructions for actuators and/or butterfly valves
- General notes for project planning