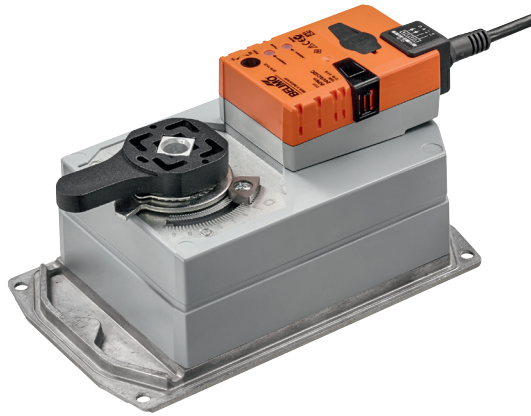

Rotary actuator for butterfly valves

- Torque motor Max. 90 Nm (not constant)
- Nominal voltage AC 230 V
- Control Open/close

Technical data

Electrical data	Nominal voltage	AC 230 V
	Nominal voltage frequency	50/60 Hz
	Nominal voltage range	AC 85...265 V
	Power consumption in operation	5 W
	Power consumption in rest position	2 W
	Power consumption for wire sizing	9 VA
	Connection supply / control	Cable 1 m, 3 x 0.75 mm ²
	Parallel operation	Yes (note the performance data)
Functional data	Torque motor	Max. 90 Nm (not constant)
	Manual override	with push-button, can be locked
	Running time motor	150 s / 90°
	Sound power level, motor	45 dB(A)
	Position indication	Mechanically (integrated)
Safety	Protection class IEC/EN	II reinforced insulation
	Protection class UL	II reinforced insulation
	Degree of protection IEC/EN	IP54
	Degree of protection NEMA/UL	NEMA 2
	Enclosure	UL Enclosure Type 2
	EMC	CE according to 2014/30/EU
	Low voltage directive	CE according to 2014/35/EU
	Certification IEC/EN	IEC/EN 60730-1 and IEC/EN 60730-2-14
	Certification UL	cULus according to UL60730-1A, UL60730-2-14 and CAN/CSA E60730-1:02
	Certification UL note	The UL marking on the actuator depends on the production site, the device is UL-compliant in any case
	Mode of operation	Type 1
	Rated impulse voltage supply / control	2.5 kV
	Control pollution degree	3
	Ambient temperature	-30...50 °C
	Storage temperature	-40...80 °C
Ambient humidity	Max. 95% r.H., non-condensing	
Servicing	maintenance-free	
Mechanical data	Connection flange	F07
Weight	Weight	4.1 kg

Safety notes



- This device has been designed for use in stationary heating, ventilation and air-conditioning systems and must not be used outside the specified field of application, especially in aircraft or in any other airborne means of transport.
- Outdoor application: only possible in case that no (sea) water, snow, ice, insolation or aggressive gases interfere directly with the actuator and that is ensured that the ambient conditions remain at any time within the thresholds according to the data sheet.
- Caution: Power supply voltage!
- Only authorised specialists may carry out installation. All applicable legal or institutional installation regulations must be complied during installation.
- The switch for changing the direction of rotation may not be adjusted.
- The angle of rotation is not permitted to be subjected to mechanical limitation. It is forbidden to alter the mechanical end stops.
- The device may only be opened at the manufacturer's site. It does not contain any parts that can be replaced or repaired by the user.
- Cables must not be removed from the device.
- The device contains electrical and electronic components and must not be disposed of as household refuse. All locally valid regulations and requirements must be observed.
- Because of its non-constant torque, the actuator is neither suitable nor released for motorisation with valves from other manufacturers. No legal entitlement can be claimed, even after extensive testing. Belimo will not be held liable and will provide no warranty.

Product features

Simple direct mounting	Simple direct mounting on the butterfly valve. The mounting orientation in relation to the butterfly valve can be selected in 90° (angle) increments.
Manual override	Manual override with push-button possible (the gear is disengaged for as long as the button is pressed or remains locked).
High functional reliability	The actuator is overload protected, requires no limit switches and automatically stops when the end stop is reached.
Combination valve/actuator	For valves with the following mechanical specifications in accordance with ISO 5211 F07: - Square stem head SW = 17 mm for form-fit coupling of the rotary actuator. - Hole circle d = 70 mm
Torque not constant	Due to the non-linear torque characteristic the actuator can only be used for butterfly valves and not for other armatures.

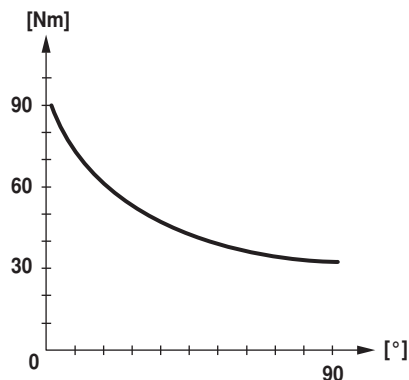

Accessories

	Description	Type
Electrical accessories	Auxiliary switch 1 x SPDT add-on	S1A
	Auxiliary switch 2 x SPDT add-on	S2A
	Feedback potentiometer 140 Ω add-on	P140A
	Feedback potentiometer 200 Ω add-on	P200A
	Feedback potentiometer 500 Ω add-on	P500A
	Feedback potentiometer 1 k Ω add-on	P1000A
	Feedback potentiometer 2.8 k Ω add-on	P2800A
	Feedback potentiometer 5 k Ω add-on	P5000A
	Feedback potentiometer 10 k Ω add-on	P10000A

Electrical installation



Notes

- Caution: Power supply voltage!

Wiring diagrams

AC 230 V, open/close

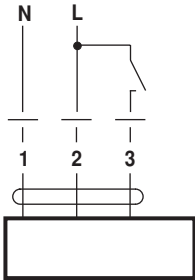

Cable colours:

- 1 = blue
- 2 = brown
- 3 = white

Dimensions [mm]

Dimensional drawings

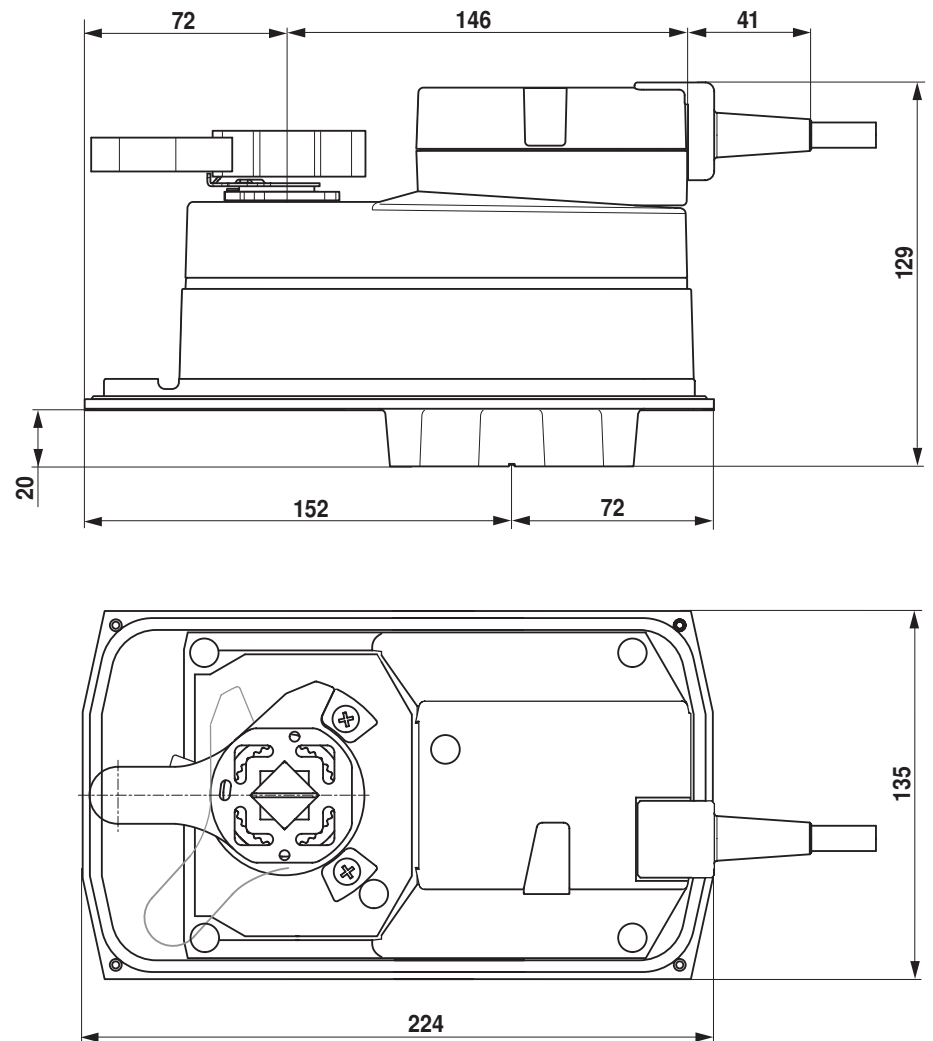

Further documentation

- The complete product range for water applications
- Data sheets for butterfly valves
- Installation instructions for actuators and/or butterfly valves
- General notes for project planning