

Damper actuator for adjusting dampers in technical building installations

- Air damper size up to approx. 3.2 m²
- Torque motor 16 Nm
- Nominal voltage AC 230 V
- Control Open/close, 3-point
- Running time motor 20 s

Technical data

Electrical data	Nominal voltage	AC 230 V
	Nominal voltage frequency	50/60 Hz
	Nominal voltage range	AC 85...265 V
	Power consumption in operation	4.5 W
	Power consumption in rest position	1 W
	Power consumption for wire sizing	8 VA
	Power consumption for wire sizing note	I _{max} 4 A @ 5 ms
	Connection supply / control	Cable 1 m, 3 x 0.75 mm ²
	Parallel operation	Yes (note the performance data)
Functional data	Torque motor	16 Nm
	Direction of motion motor	selectable with switch 0 (ccw rotation) / 1 (cw rotation)
	Manual override	with push-button, can be locked
	Angle of rotation	Max. 95°
	Angle of rotation note	can be limited on both sides with adjustable mechanical end stops
	Running time motor	20 s / 90°
	Sound power level, motor	55 dB(A)
	Mechanical interface	Universal shaft clamp reversible 10...20 mm
	Position indication	Mechanically, pluggable
Safety	Protection class IEC/EN	II reinforced insulation
	Protection class UL	II reinforced insulation
	Degree of protection IEC/EN	IP54
	Degree of protection NEMA/UL	NEMA 2
	Enclosure	UL Enclosure Type 2
	EMC	CE according to 2014/30/EU
	Low voltage directive	CE according to 2014/35/EU
	Certification IEC/EN	IEC/EN 60730-1 and IEC/EN 60730-2-14
	Certification UL	cULus according to UL60730-1A, UL60730-2-14 and CAN/CSA E60730-1:02
	Certification UL note	The UL marking on the actuator depends on the production site, the device is UL-compliant in any case
	Mode of operation	Type 1
	Rated impulse voltage supply / control	4 kV
	Control pollution degree	3
	Ambient temperature	-30...50°C
	Storage temperature	-40...80°C
Ambient humidity	Max. 95% r.H., non-condensing	
Servicing	maintenance-free	
Weight	Weight	1.8 kg

Safety notes



- The device must not be used outside the specified field of application, especially not in aircraft or in any other airborne means of transport.
- Outdoor application: only possible in case that no (sea) water, snow, ice, insolation or aggressive gases interfere directly with the actuator and that is ensured that the ambient conditions remain at any time within the thresholds according to the data sheet.
- Caution: Power supply voltage!
- Only authorised specialists may carry out installation. All applicable legal or institutional installation regulations must be complied during installation.
- The device may only be opened at the manufacturer's site. It does not contain any parts that can be replaced or repaired by the user.
- Cables must not be removed from the device.
- To calculate the torque required, the specifications supplied by the damper manufacturers concerning the cross-section, the design, the installation site and the ventilation conditions must be observed.
- The device contains electrical and electronic components and must not be disposed of as household refuse. All locally valid regulations and requirements must be observed.

Product features

Simple direct mounting	Simple direct mounting on the damper shaft with a universal shaft clamp, supplied with an anti-rotation device to prevent the actuator from rotating.
Manual override	Manual override with push-button possible (the gear is disengaged for as long as the button is pressed or remains locked).
Adjustable angle of rotation	Adjustable angle of rotation with mechanical end stops.
High functional reliability	The actuator is overload protected, requires no limit switches and automatically stops when the end stop is reached.

Accessories

	Description	Type
Electrical accessories	Auxiliary switch 1 x SPDT add-on	S1A
	Auxiliary switch 2 x SPDT add-on	S2A
	Auxiliary switch 2 x SPDT add-on, grau	S2A/300 GR
	Auxiliary switch 2 x SPDT add-on, grau	S2A/500 GR
	Feedback potentiometer 200 Ω add-on	P200A
	Feedback potentiometer 500 Ω add-on	P500A
	Feedback potentiometer 500 Ω add-on, grau	P500A GR
	Feedback potentiometer 1 kΩ add-on	P1000A
	Feedback potentiometer 2.8 kΩ add-on	P2800A
	Feedback potentiometer 2.8 kΩ add-on, grau	P2800A GR
	Feedback potentiometer 1 kΩ add-on, grau	P1000A GR
	Feedback potentiometer 5 kΩ add-on	P5000A
	Feedback potentiometer 5 kΩ add-on, grau	P5000A GR
	Feedback potentiometer 10 kΩ add-on	P10000A
	Feedback potentiometer 10 kΩ add-on, grau	P10000A GR
Mechanical accessories	Description	Type
	Actuator arm for standard shaft clamp (reversible)	AH-20
	Shaft extension 240 mm Ø20 mm for damper shaft Ø 12...21 mm CrNi	AV12-25-I
	Shaft extension 240 mm Ø20 mm for damper shaft Ø 8...22.7 mm	AV8-25
	Ball joint suitable for damper crank arm KH8	KG8
	Ball joint suitable for damper crank arm KH8 / KH10	KG10A
	Damper crank arm Slot width 8.2 mm, clamping range Ø10...18 mm	KH8
Shaft clamp one-sided, clamping range Ø8...26 mm, Multipack 20 pcs.	K-ENSA	

Accessories

Description	Type
Shaft clamp one-sided, clamping range Ø12...26 mm, for CrNi shaft (INOX), Multipack 20 pcs.	K-ENSA-I
Shaft clamp reversible, clamping range Ø10...20 mm	K-SA
Anti-rotation mechanism 180 mm, Multipack 20 pcs.	Z-ARS180
Anti-rotation mechanism 230 mm, Multipack 20 pcs.	Z-ARS230
Form fit insert 10x10 mm, Multipack 20 pcs.	ZF10-NSA
Form fit insert 12x12 mm, Multipack 20 pcs.	ZF12-NSA
Form fit insert 15x15 mm, Multipack 20 pcs.	ZF15-NSA
Form fit insert 16x16 mm, Multipack 20 pcs.	ZF16-NSA
Mounting kit for linkage operation for flat installation	ZG-SMA
Position indicator, Multipack 20 pcs.	Z-PI
Base plate extension for SM..A to SM../AM../SMD24R, Multipack 20 pcs.	Z-SMA

Electrical installation



Notes

- Caution: Power supply voltage!
- Parallel connection of other actuators possible. Observe the performance data.

Wiring diagrams

AC 230 V, open/close

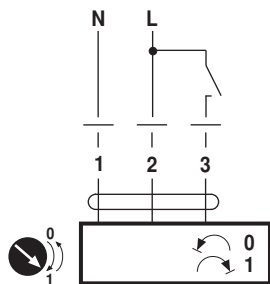

Cable colours:
1 = blue
2 = brown
3 = white



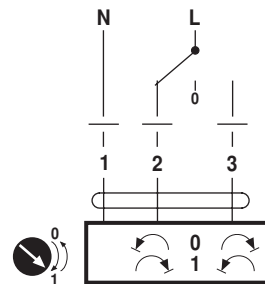

AC 230 V, 3-point

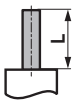

Cable colours:
1 = blue
2 = brown
3 = white

Dimensions [mm]

Spindle length

		Min. 48
		Min. 20

Clamping range

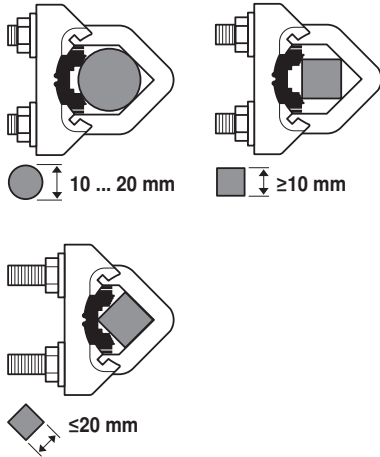

When using a round spindle made of CrNi (INOX): Ø 12...20 mm

Dimensional drawings

