

RobustLine damper actuator for adjusting dampers in industrial plants and in technical building installations

- Air damper size up to approx. 4 m²
- Torque motor 20 Nm
- Nominal voltage AC/DC 24 V
- Control Open/close, 3-point
- Optimum protection against corrosion and chemical influences, UV radiation, damp and condensation



Technical data

Electrical data	Nominal voltage	AC/DC 24 V
	Nominal voltage frequency	50/60 Hz
	Nominal voltage range	AC 19.2...28.8 V / DC 19.2...28.8 V
	Power consumption in operation	2 W
	Power consumption in rest position	0.2 W
	Power consumption for wire sizing	4 VA
	Connection supply / control	Cable 1 m, 3 x 0.75 mm ² (halogen-free)
	Parallel operation	Yes (note the performance data)
Functional data	Torque motor	20 Nm
	Direction of motion motor	selectable with switch 0 (ccw rotation) / 1 (cw rotation)
	Manual override	with push-button, can be locked
	Angle of rotation	Max. 95°
	Angle of rotation note	can be limited on both sides with adjustable mechanical end stops
	Running time motor	150 s / 90°
	Sound power level, motor	45 dB(A)
	Mechanical interface	Universal shaft clamp 14...20 mm
	Position indication	Mechanically, pluggable
Safety data	Protection class IEC/EN	III Safety Extra-Low Voltage (SELV)
	Protection class UL	UL Class 2 Supply
	Degree of protection IEC/EN	IP66/67
	Degree of protection NEMA/UL	NEMA 4X UL Enclosure Type 4X
	EMC	CE according to 2014/30/EU
	Certification IEC/EN	IEC/EN 60730-1 and IEC/EN 60730-2-14
	Certification UL	cULus according to UL60730-1A, UL60730-2-14 and CAN/CSA E60730-1:02 The UL marking on the actuator depends on the production site, the device is UL-compliant in any case
	Mode of operation	Type 1
	Rated impulse voltage supply / control	0.8 kV
	Control pollution degree	4
	Ambient temperature	-30...50°C
	Storage temperature	-40...80°C
	Ambient humidity	Max. 100% r.H.
	Servicing	maintenance-free
Weight	Weight	1.7 kg

Safety notes



- The device must not be used outside the specified field of application, especially not in aircraft or in any other airborne means of transport.
- Only authorised specialists may carry out installation. All applicable legal or institutional installation regulations must be complied during installation.
- Junction boxes must at least correspond with enclosure IP degree of protection!
- The cover of the protective housing may be opened for adjustment and servicing. When it is closed afterwards, the housing must seal tight (see installation instructions).
- The device may only be opened at the manufacturer's site. It does not contain any parts that can be replaced or repaired by the user.
- Cables must not be removed from the device.
- To calculate the torque required, the specifications supplied by the damper manufacturers concerning the cross-section, the design, the installation site and the ventilation conditions must be observed.
- The device contains electrical and electronic components and must not be disposed of as household refuse. All locally valid regulations and requirements must be observed.
- The information on chemical resistance refers to laboratory tests with raw materials and finished products and to trials in the field in the areas of application indicated.
- The materials used may be subjected to external influences (temperature, pressure, constructional fixture, effect of chemical substances, etc.), which cannot be simulated in laboratory tests or field trials.
- The information regarding areas of application and resistance can therefore only serve as a guideline. In case of doubt, we definitely recommend that you carry out a test. This information does not imply any legal entitlement. Belimo will not be held liable and will provide no guarantee. The chemical or mechanical resistance of the materials used is not alone sufficient for judging the suitability of a product. Regulations pertaining to combustible liquids such as solvents etc. must be taken into account with special reference to explosion protection.
- Flexible metallic cable conduits or threaded cable conduits of equal value are to be used for UL (NEMA) Type 4X applications.
- When used under high UV loads, e.g. extreme sunlight, the use of flexible metallic or equivalent cable conduits is recommended.

Product features

Fields of application	The actuator is particularly suitable for utilisation in outdoor applications and is protected against the following weather conditions: <ul style="list-style-type: none"> - Wood drying - Animal breeding - Food processing - Agriculture - Indoor swimming pools / bathhouses - Rooftop ventilation plant rooms - General outdoor applications - Alternating climate - Laboratories
Resistances	Noxious gas test EN 60068-2-60 (Fraunhofer Institut ICT / DE) Salt fog spray test EN 60068-2-52 (Fraunhofer Institut ICT / DE) Ammoniac test DIN 50916-2 (Fraunhofer Institut ICT / DE) Climate test IEC60068-2-30 (Trikon Solutions AG / CH) Disinfectant (animals) (Trikon Solutions AG / CH) UV Test (Solar radiation at ground level) EN 60068-2-5, EN 60068-2-63 (Quinel / Zug CH)
Used materials	Actuator housing polypropylene (PP) Cable glands / hollow shaft polyamide (PA) Connecting cable FRNC Clamp / screws in general Steel 1.4404 Seals EPDM Form fit insert aluminium anodised
Simple direct mounting	Simple direct mounting on the damper shaft with a universal shaft clamp, supplied with an anti-rotation device to prevent the actuator from rotating.
Manual override	Manual override with push-button possible (the gear is disengaged for as long as the button is pressed or remains locked).

- Adjustable angle of rotation** Adjustable angle of rotation with mechanical end stops. Standard setting 0...90°. The housing cover must be removed to set the angle of rotation.
- High functional reliability** The actuator is overload protected, requires no limit switches and automatically stops when the end stop is reached.

Accessories

Electrical accessories	Description	Type
	Feedback potentiometer 10 kΩ add-on	P10000A
	Feedback potentiometer 1 kΩ add-on	P1000A
	Feedback potentiometer 140 Ω add-on	P140A
	Feedback potentiometer 200 Ω add-on	P200A
	Feedback potentiometer 2.8 kΩ add-on	P2800A
	Feedback potentiometer 5 kΩ add-on	P5000A
	Feedback potentiometer 500 Ω add-on	P500A
	Auxiliary switch 2 x SPDT add-on, grey	S2A GR

Electrical installation



Supply from isolating transformer.
Parallel connection of other actuators possible. Observe the performance data.

Wiring diagrams

AC/DC 24 V, open/close

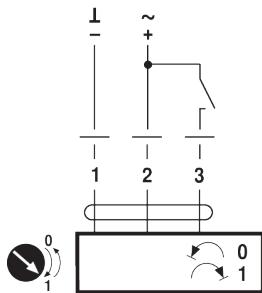

Cable colours:
1 = black
2 = red
3 = white

AC/DC 24 V, 3-point

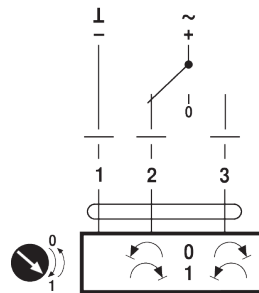



Cable colours:
1 = black
2 = red
3 = white

Dimensions

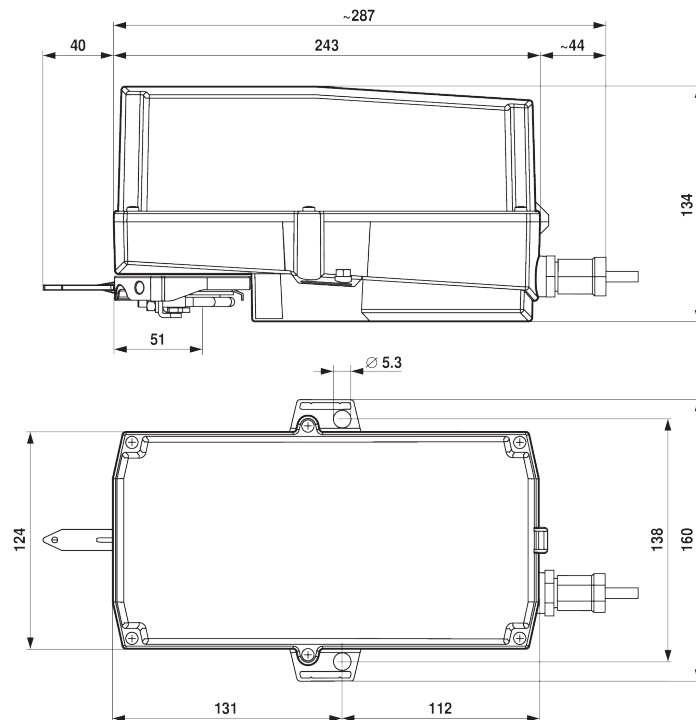
Dimensional drawings



Clamping range

		
14...20	10...14	14...20

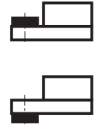
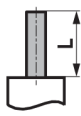
Shaft length

20...58