

Damper actuator for adjusting dampers in technical building installations

- Air damper size up to approx. 0.4 m²
- Torque motor 2 Nm
- Nominal voltage AC/DC 24 V
- Control Open/close, 3-point
- with connecting terminals



Technical data

Electrical data	Nominal voltage	AC/DC 24 V
	Nominal voltage frequency	50/60 Hz
	Nominal voltage range	AC 19.2...28.8 V / DC 19.2...28.8 V
	Power consumption in operation	0.5 W
	Power consumption in rest position	0.2 W
	Power consumption for wire sizing	1 VA
	Connection supply / control	Terminals 1.5 mm ² Cu wire or 1.0 mm ² Cu strands (3-wire)
	Parallel operation	Yes (note the performance data)
Functional data	Torque motor	2 Nm
	Direction of motion motor	counter-clockwise rotation
	Manual override	with magnet
	Angle of rotation	0...287.5°
	Angle of rotation note	Without limitation: endless 315° with one end stop clip mounted on the actuator
	Running time motor	75 s / 90°
	Sound power level, motor	35 dB(A)
	Mechanical interface	Universal shaft clamp 6...12.7 mm
	Position indication	Mechanically, pluggable (with integrated magnet for gear disengagement)
	Safety data	Protection class IEC/EN
Power source UL		Class 2 Supply
Degree of protection IEC/EN		IP20
Degree of protection NEMA/UL		NEMA 1
Enclosure		UL Enclosure Type 1
EMC		CE according to 2014/30/EU
Certification IEC/EN		IEC/EN 60730-1 and IEC/EN 60730-2-14
Certification UL		cULus according to UL60730-1A, UL60730-2-14 and CAN/CSA E60730-1 The UL marking on the actuator depends on the production site, the device is UL-compliant in any case
Mode of operation		Type 1
Rated impulse voltage supply / control		0.8 kV
Pollution degree		2
Ambient temperature		-30...50°C
Storage temperature		-40...80°C
Ambient humidity		Max. 95% RH, non-condensing
Servicing		maintenance-free

Weight Weight 0.21 kg

Safety notes

- The device must not be used outside the specified field of application, especially not in aircraft or in any other airborne means of transport.
- Outdoor application: only possible in case that no (sea) water, snow, ice, insulation or aggressive gases interfere directly with the device and that it is ensured that the ambient conditions remain within the thresholds according to the data sheet at any time.
- Only authorised specialists may carry out installation. All applicable legal or institutional installation regulations must be complied during installation.
- The device may only be opened at the manufacturer's site. It does not contain any parts that can be replaced or repaired by the user.
- To calculate the torque required, the specifications supplied by the damper manufacturers concerning the cross-section, the design, the installation situation and the ventilation conditions must be observed.
- The device contains electrical and electronic components and must not be disposed of as household refuse. All locally valid regulations and requirements must be observed.

Product features

- Simple direct mounting** The actuator is mounted directly on the damper shaft (Ø 6...12.7 mm) with a universal shaft clamp and then secured with the anti-rotation clip, to prevent it from rotating. The anti-rotation clip Z-ARCM is included in the scope of delivery.
- Manual override** Manual override with magnet possible (the gear is disengaged as long as the magnet adheres to the magnet symbol). The magnet for gear disengagement is integrated in the position indication.
- Adjustable angle of rotation** Adjustable angle of rotation with mechanical end stops.
- High functional reliability** The actuator is overload protected, requires no limit switches and automatically stops when the end stop is reached.

Accessories

Mechanical accessories	Description	Type
	Shaft extension 170 mm Ø10 mm for damper shaft Ø 6...16 mm	AV6-20
	Anti-rotation clip, Multipack 20 pcs.	Z-ARCM
	End stop clip, Multipack 20 pcs.	Z-ESCM
	Gear disengagement magnet, Multipack 20 pcs.	Z-MA
	Position indicator, Multipack 20 pcs.	Z-PICM

Electrical installation



Supply from isolating transformer.
Parallel connection of other actuators possible. Observe the performance data.

Wiring diagrams

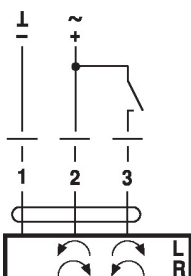
AC/DC 24 V, open/close

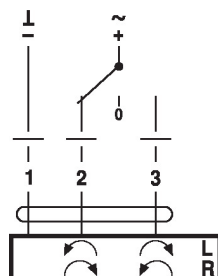

AC/DC 24 V, 3-point



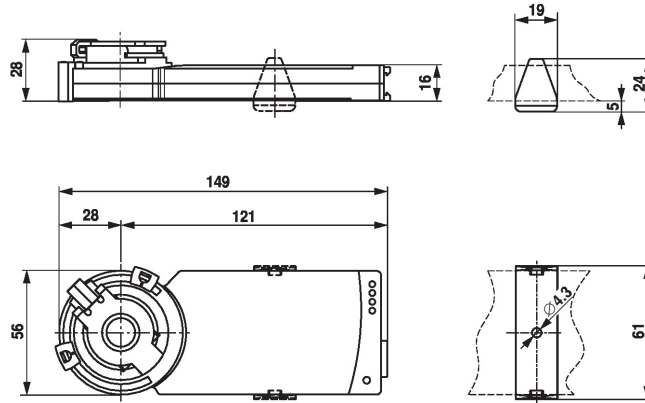

Dimensions

Dimensional drawings



Clamping range

		
6...12.7	6 / 8 / 10	6...12.7

Shaft length

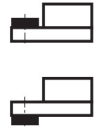
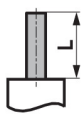

Min. 32